



LISTA DE PRECIOS 2024

COD-01042024



HOMEA
PREMIUM

HOMEA

www.homea.mx

Email: ventas@homea.mx

Whatsapp: (442)258.0251

Tel: (442)216.3552

Lada sin Costo: 01(800)701.2121



TERMINOS Y CONDICIONES

- Por ser nuestra línea de productos de importación, las listas de precios se manejan en dólares americanos y los artículos se liquidan en dolares americanos o pesos mexicanos al tipo de cambio que HOMEA este manejando el día de pago esto para evitar que paguen al tipo de cambio que maneje el banco o diario oficial. Los precios no incluyen IVA.
- El flete en todos los casos es por cobrar, con excepción de las ciudades de Monterrey, México, Guadalajara y sus zonas metropolitanas; siempre y cuando la orden de compra sea de un mínimo de **\$500.00 USD + IVA**.
- No nos hacemos responsables por los riesgos del transporte, por lo que es necesario inspeccionar perfectamente la mercancía recibida, y en caso de ser necesaria, efectuar la reclamación con anotación en la guía y fotografías del daño. Solo en caso de que la mercancía recibida sea mayor a 10 piezas se otorgará un plazo de 48 horas para su reclamación.

PAGOS.

Para compras regulares de mercancía, el pago se realiza por anticipado a través de depósito bancario, es necesario contar con número de referencia para poder realizar el depósito el cual debe de ser consultado con su ejecutivo de cuenta.

- Una vez que se haya recibido la confirmación de sus pedidos por escrito, no se aceptan cambios o cancelaciones.
- Para ordenes de producto especiales o material SKU será necesario un anticipo del 50%.

DEVOLUCIONES

- Toda la devolución debe tener una autorización previa por escrito por parte de HOMEA
- Únicamente se aceptan devoluciones de productos que manejamos para entrega inmediata.
- Es necesario que el producto a devolver se encuentre en perfecto estado así como su empaque, es decir, en condiciones de venderse como producto nuevo.
- Toda devolución causará un 20% de cargo.
- Toda devolución debe ser hecha con flete pagado por quien lo envía y asumir el riesgo de envío; si el producto presenta algún daño, no se aceptará y por consiguiente no se emitirá ninguna nota de crédito.
- Nos reservamos el derecho de aceptar o no una devolución.
- No se aceptan devoluciones después de 30 días de haber recibido el material.
- No se aceptan devoluciones de productos que no son SKU.

REFRIGERADORES

BERTAZZONI	Código	Descripción	Color	Precio
	REF36DFIXNV	36" French door refrigerator - Freestanding - Stainless	Acero	\$4,310
	HK36MASFDX	Handles Kit Master Series 36" french door (901248)	Acero	\$448
	HK36PROFDX	Handles Kit Professional Series 36" french door (901249)	Acero	\$405
	HK36HERFDX	Handles Kit Heritage Series 36" french door (901250)	Acero	\$487
	DS2HERTSB	Black nickel decor set	Black nickel	\$1,119
	DS2HERTGO	Gold decor set	Gold	\$1,119
	DS2HERTPC	Copper decor set	Copper	\$1,119
<p>*Jaladeras no incluidas. Debe cotizarse equipo + jaladeras.</p>				
<p>Especificaciones</p>				
Size	36 in	Door storage	6 gallon sized bins	
Volume	Ref 15.9 cu.ft / Frz 6.6 cu.ft	Ice maker	Automatic ice maker 3.08 lbs / 24h	
Door finish	Stainless steel look	Settings	Super cool, Super freeze, Ice maker	
User interface	Internal digital LED touch interface	Lighting	Top and sidewall LED lights	
Refrigerator shelves	1 fixed and 4 height-adjustable, of which 1 retractable	<p>Technical specifications</p>		
Refrigerator crisper	1 large with preset temperature + 2 medium with adjustable humidity	Electrical supply	115 V 60 HZ - 190 W - 2.5 Amp	
Freezer compartment	2 drawers	Power connection	NEMA 5-15P with 67" power cord	
		Sound rating	45 dbA	
		Water connection	1/4" waterline with shut-off valve	
		Water supply pressure	MIN 0.15 MPa (1.5 Bar, 21.32 PSI) MAX 0.83 MPa (8.3 Bar, 120.96 PSI)	
		Certification	CEC,UL	
		Warranty	2 years parts & labor	
		Packaging dimensions	W 38 3/16" H 72 7/16" D 30 9/16"	
		Weight	298.0 lbs	



Productos con existencias disponibles. Lista de precios al público. Los precios están expresados en dolares americanos y no incluyen IVA.

BERTAZZONI	Código	Descripción	Color	Precio
	REF36BMBZPNV	36 inch Bottom Mount Built-in Refrigerator Panel Ready with ice maker & internal water dispenser. Reversible door.	Acero	\$8,253
	PROHK36PI	Handle kit - Professional series for REF36BMBZPNV (cod. tecnico 901462)		\$355
	MASHK36PI	Handle kit - Master series for REF36BMBZPNV (cod. tecnico 901463)		\$355
	HERHK36P	Handle kit - Heritage series for REF36BMBZPNV (cod. tecnico 901509)		\$711
	SP36BMX	Stainless steel door panels kit for REF36BMBZPNV (codigo tecnico 901609)		\$1,400
	CTXV	Union Kit for 2 units of REF36BMBZPNV (codigo tecnico 901602)		\$123
Especificaciones				
Size	36 in	Door storage	1 gallon sized + 2 height adjustable bins	
Volume	Ref 14.2 cu.ft / Frz 5.6 cu.ft	Ice maker	Automatic ice maker 3.9 lbs / 24hrs	
Door finish	Panel Ready	Settings	Super cool, Super freeze, Ice maker, Water filter replacement alarm. Water dispenser, Eco mode, vacation mode. Sabbath mode.	
User interface	Internal digital LED touch interface	Lighting	Top and sidewall LED lights	
Refrigerator shelves	1 stationary + 2 height-adjustable	Refrigerator drawers	1 + 1 fresco drawer with separate temperature control	
Refrigerator drawers	1 + 1 fresco drawer with separate temperature control	Freezer compartment	2 drawers	
Technical specifications				
Electrical supply	115 V 60 HZ - 120 W - 3 Amp			
Power connection	NEMA 5-15P with 90" power cord			
Sound rating	43 dbA			
Water connection	1/4" waterline with shut-off valve			
Water supply pressure	25-80 psi (1.7-5.5 bar)			
Certification	ADA Compliant,CB,CEC,ETL			
Warranty	2 years parts & labor			
Packaging dimensions	W 38 3/16" H 90 9/16" D 26 3/8"			
Weight	417.0 lbs			



BERTAZZONI	Código	Descripción	Color	Precio
	REF24BMBPNB	24" Bottom Mount integrated panel ready sliding door	White	\$1,762
	Especificaciones			
Worktop		Technical specifications		
Size	24 in	Voltage, Frequency, Amps	115 V 60 HZ - 85 W - 0.8 Amp	
Volume	Ref 6.2 cu.ft / Frz 2.4 cu.ft	Power Connection	NEMA 5-15P with 41" power cord	
Finishing	White	Certification	CEC / ETL	
Door finish	Panel ready	Energy star	Yes	
Interface	Internal digital LED touch interface	Warranty	2 years parts & labor	
Lighting	LED on top	Packaging dimensions and weight	W 22 7/16" H 72 7/16" D 22 9/16" Weight 139.0lbs	
Refrigerator shelves	1 stationary + 3 height adjustable			
Refrigerator drawers	1 + 1 fresco drawer with separate temperature and humidity control			
Freezer compartment	3 drawers			
Door storage	1 bin with lid - 2 height adjustable open bins			
Settings	Super cool, Super freeze, Eco mode, Vacation mode			

SIDE

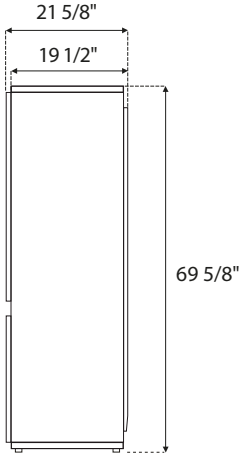

FRONT

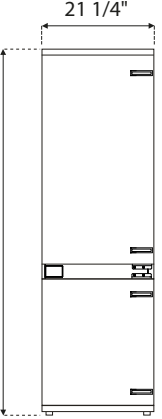

TOP

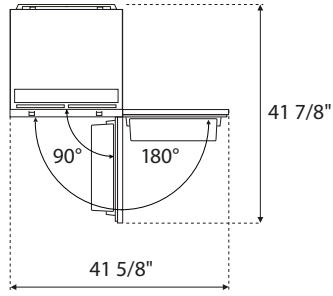

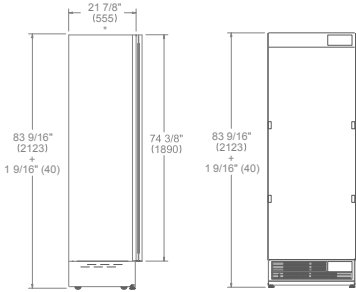

COLUMNAS DE REFRIGERADOR

BERTAZZONI	Código	Descripción	Color	Precio
 	REF30RCBPNV	30" Refrigerator (Larder), reversible, panel ready	Acero	\$6,227
	Especificaciones			
Size	30 in	Refrigerator drawers	1 crisper + 3 Fresco drawers with separate temperature control	
Cooling system	frost free	Door storage	1 height-adjustable gallon-sized bin + 2 stationary bins	
User interface	LED touch control interface	Water filter	internal	
Display functions	Door ajar alarm, Super Cool, Water filter replacement reminder, Water dispenser, Eco Mode, Vacation Mode, Sabbath Mode	Water supply pressure	25 psi to 80 psi	
Lighting	LED side & top rail illumination	Sound rating	43 dbA	
Door ajar alarm	yes	Certification	ADA Compliant, CEC, ETL	
Door finishing	panel ready	DOE compliant	yes	
Cabinet finishing	stainless steel back wall	Technical specifications		
Refrigerator net capacity	16.7 cu.ft	Sound rating	43	
Refrigerator shelves	3 height-adjustable + 1 stationary	Electrical supply	115 V - 60 Hz - 112 W - 2 Amp	
		Power connection	NEMA 5-15P with 90" power cord	
		Energy consumption	325.0 kWh/yr	
BERTAZZONI	Código	Descripción	Color	Precio
*Disponible 2025	REF24RCBPNV	24" Refrigerator (Larder), reversible, panel ready	Acero	\$5,843

COLUMNAS DE CONGELADOR

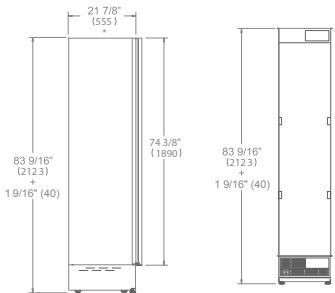
BERTAZZONI	Código	Descripción	Color	Precio
 	REF18FCBIPLV	18" Freezer, left hinge, panel ready	Acero	\$5,650
	Especificaciones			
Size	18 in	Freezer drawers	4	
Cooling system	frost free	Automatic ice maker	yes	
User interface	LED touch control interface	Ice production capacity	3.9 lbs/24hrs	
Display functions	Door ajar alarm, Super Freeze, Ice maker, Water filter replacement reminder, Eco mode, Vacation mode, Sabbath mode	Water filter	internal	
Lighting	LED lights on sides and top	Water supply pressure	25 psi to 80 psi	
Door ajar alarm	yes	Sound rating	43 dbA	
Door finishing	panel ready	Certification	ADA Compliant, CEC, ETL	
Cabinet finishing	stainless steel back wall	DOE compliant	yes	
Door storage	3 height-adjustable bins	Technical specifications		
Freezer net capacity	8.6 cu.ft ³	Sound rating	43	
Freezer shelves	3 height-adjustable + 1 stationary	Electrical supply	115 V - 60 Hz - 160 W - 2 Amp	
		Power connection	NEMA 5-15P with 90" power cord	
		Energy consumption	452.0 kWh/yr	
BERTAZZONI	Código	Descripción	Color	Precio
*Disponible 2025	REF24FCBIPNV	24" Freezer, reversible, panel ready	Acero	\$6,227

COLUMNAS DE VINO

BERTAZZONI	Código	Descripción	Color	Precio
*Disponibles 2025	REF18WCBPRV	18" Wine Cellar, right hinges, panel ready	Acero	\$6,227
	REF18WCBPLV	18" Wine Cellar, left hinges, panel ready	Acero	\$6,227
	REF24WCBPNV	24" Wine Cellar, reversible, panel ready	Acero	\$6,612

ACCESORIOS

ACCESORIOS PARA REFRIGERADORES		
Código	Descripción	Precio
SP18CX	Steel panels for REF18FCBIP.V	\$1,071
SP30CX	Steel panels for REF30RCBPNV	\$1,429
SP24CX	Steel panels for columns RED24 (RC&FC)	\$1,214
MASHKCOL	Master Series handle kit for premium columns	\$265
PROHKCOL	Professional Series handle kit for premium columns	\$281
HERHKCOL	Heritage Series handle kit for premium columns	\$223

ACCESORIOS PARA CAVAS		
Código	Descripción	Precio
SP18WXV	Steel panels for REF18WCBPV	\$1,071
SP24WXV	Steel panels for REF24WCBPNV	\$1,214



Productos con existencias disponibles. Lista de precios al público. Los precios están expresados en dolares americanos y no incluyen IVA.

ESTUFAS 36" MASTER SERIES

BERTAZZONI	Código	Descripción	Color	Precio
	MAS365GASXVLP	36" Master Series range - Gas oven - 5 aluminum burners (NG conversion kit included) LP	Acero	\$5,116
	MAS365GASNEV	36" Master Series Range - Gas oven - 5 aluminum burners	Negro	\$5,770
	MAS365GASBIV	36" Master Series Range - Gas oven - 5 aluminum burners	Blanco	\$5,770
Especificaciones				
Worktop		Oven Cavity		
Size	36 in	Oven configuration	single	
Cooking zones	5	Oven fuel	gas	
Gas zones	5	Oven type	fan assisted gas	
Worktop type	gas	Oven broiler type	gas	
Worktop design	stainless steel squared	Cooking modes	bake / broiler / convection bake	
Worktop controls	Knobs	Oven volume	5.9 ft ³	
Knobs	solid metal	Oven convection system	dual horizontal fans	
Burner type	aluminium	Oven controls	knobs / thermometer	
Grates	cast iron	Inner oven door	triple	
Continuous grating	yes	Removable inner glass	yes	
Thermocouple safety device	yes	Cooling fan	yes	
One-hand ignition	yes	Oven levels	7	
Backguard	yes	Door hinge	soft-motion	
Wok ring	yes	Wire-shelves	2 standard with handle	
Simmer ring	yes	Tray	1 baking tray with grill trivet	
Cookinf zones		Grill trivet for tray	yes	
Power burners	1300 BTU/h - 19 000 BTU/h (1)	Oven lights	double lateral	
Rapid burner	2500 BTU/h - 10 400 BTU/h (1)	Bottom		
Medium burner	1500 BTU/h - 5900 BTU/h (2)	Legs	stainless steel	
Simmer burner	750 BTU/h - 3500 BTU/h (1)	Technical specifications		
		Absorbed current (A)	2.5 A with dedicated circuit	
		Electrical supply	110V 60 Hz - 300W	

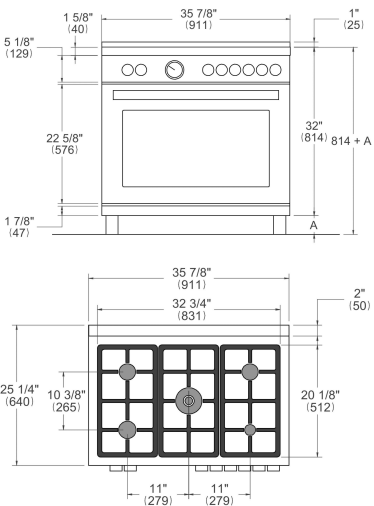

ESTUFAS 36" PROFESSIONAL SERIES

BERTAZZONI	Código	Descripción	Color	Precio
	PRO366BCFGMXT	36" Professional Series range - Gas oven - 6 brass burners	Acero	\$6,594
	PRO366BCFGMNET	36" Professional Series range - Gas oven - 6 brass burners	Negro	\$8,595
	PRO366BCFGMBIT	36" Professional Series range - Gas oven - 6 brass burners	Blanco	\$8,595
	PRO366BCFGMGIT	36" Professional Series range - Gas oven - 6 brass burners	Amarillo	\$8,595
	PRO366BCFGMART	36" Professional Series range - Gas oven - 6 brass burners	Naranja	\$8,595
	PRO366BCFGMROT	36" Professional Series range - Gas oven - 6 brass burners	Rojo	\$8,595
	PRO366BCFGMXTLP	36" Professional Series range - Gas oven - 6 brass burners LP Version	Version LP	\$6,594

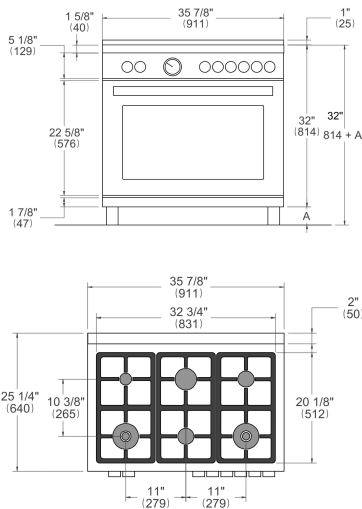



Especificaciones

Worktop		Oven Cavity	
Size	36 in	Oven configuration	single
Cooking zones	6	Oven fuel	gas
Gas zones	6 Burners	Oven type	fan assisted gas
Worktop type	gas	Oven broiler type	gas
Worktop design	stainless steel squared	Oven functions	bake / broiler / convection bake
Knobs	metal coated	Oven volume	5.9 ft ³
Burner type	brass	Oven convection system	dual horizontal fans
Grates	cast iron	Inner oven door	triple
Continous grating	yes	Removable inner glass	yes
Thermocouple safety device	yes	Cooling fan	yes
One-hand ignition	yes	Oven levels	7
Backguard	yes	Door hinge	soft-close
Wok ring	yes	Sliding shelves	2 sets of telescopic glides
Simmer ring	yes	Wire-shelves	2 heavy duty
Cast iron griddle	yes	Tray	1 baking tray with grill trivet
		Grill trivet for tray	yes
		Oven lights	double lateral
Cookinf zones		Bottom	
Power burners	1300 BTU/h - 19 000 BTU/h (2)	Legs	stainless steel
Rapid burner	2500 BTU/h - 10 400 BTU/h (1)		
Medium burner	1500 BTU/h - 5900 BTU/h (2)	Technical specifications	
Simmer burner	900 BTU/h - 3500 BTU/h (1)	Absorbed current (A)	2.5 A with dedicated circuit
		Electrical supply	110V 60 Hz - 300W



ESTUFAS 48" MASTER SERIES

BERTAZZONI	Código	Descripción	Color	Precio
	MAS486GGASXVLP	48" Master Series range - Gas Oven - 6 aluminum (NG conversion kit included)	Acero Version LP	\$9,693
	MAS486GGASNEV	48" Master Series range - Gas Oven - 6 aluminum burners + griddle	Negro	\$10,475
	MAS486GGASBIV	48" Master Series range - Gas Oven - 6 aluminum	Blanco	\$10,475
Especificaciones				
Worktop		Oven Cavity		
Size	48 in	Oven configuration	double	
Cooking zones	7	Oven fuel	gas	
Gas zones	6 Burners	Oven convection system	dual horizontal fans	
Griddle zones	electric	Main oven type	fan assisted gas	
Worktop type	electric / gas	Main oven broiler type	gas	
Worktop design	stainless steel squared	Main oven functions	bake / broiler / convection bake	
Worktop controls	Knobs	Main oven volume	4.7 ft ³	
Knobs	solid metal	Auxiliary oven type	gas conventional	
Burner type	aluminium	Auxiliary oven functions	bake	
Grates	cast iron	Auxiliary oven volume	2.4 ft ³	
Continous grating	yes	Oven control	knobs / thermometer	
Thermocouple safety device	yes	Inner oven door	triple	
One-hand ignition	yes	Removable inner glass	yes	
Backguard	yes	Cooling fan	yes	
Simmer ring	yes	Oven levels	7	
Cookinf zones		Door hinge	soft-motion	
Power burners	1300 BTU/h - 19 000 BTU/h (2)	Wire-shelves	2 each cavity	
Rapid burner	2500 BTU/h - 10 400 BTU/h (1)	Tray	1 baking tray with grill trivet	
Medium burner	1500 BTU/h - 5900 BTU/h (2)	Grill trivet for tray	yes	
Simmer burner	750 BTU/h - 3500 BTU/h (1)	Oven lights	double lateral	
Griddle power	1100 W	Bottom		
		Legs	stainless steel	
Technical specifications				
		Absorbed current (A)	10 A with dedicated circuit	
		Electrical supply	110V 60 Hz - 1200W	

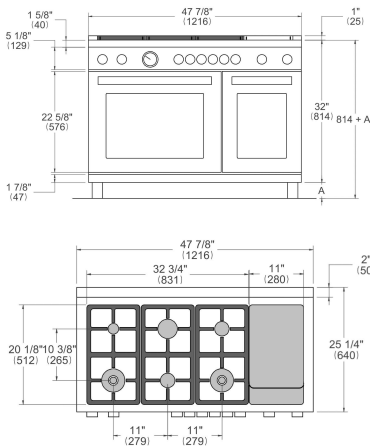

ESTUFAS 48" PROFESSIONAL SERIES

BERTAZZONI	Código	Descripción	Color	Precio
	PRO486BTFGMXT	48" Professional Series range - Gas Oven - 6 brass burners + griddle	Acero	\$11,040
	PRO486BTFGMNET	48" Professional Series range - Gas Oven - 6 brass burners + griddle	Negro	\$12,593
	PRO486BTFGMBIT	48" Professional Series range - Gas Oven - 6 brass burners + griddle	Blanco	\$12,593
	PRO486BTFGMGIT	48" Professional Series range - Gas Oven - 6 brass burners + griddle	Amarillo	\$12,593
	PRO486BTFGMART	48" Professional Series range - Gas Oven - 6 brass burners + griddle	Naranja	\$12,593
	PRO486BTFGMROT	48" Professional Series range - Gas Oven - 6 brass burners + griddle	Rojo	\$12,593
	PRO486BTFGMXTLP	48" Professional Series range - Gas Oven - 6 brass burners + griddle LP Version	Versión LP	\$11,040
		Especificaciones		
Worktop		Oven Cavity		
Size	48 in	Oven configuration	double	
Cooking zones	7	Oven fuel	gas	
Gas zones	6 Burners	Oven type	gas conventional	
Griddle zones	electric	Oven convection system	dual horizontal fans	
Worktop type	electric / gas	Main oven type	fan assisted gas	
Worktop design	stainless steel squared	Main oven broiler type	gas	
Worktop controls	knobs	Main oven functions	bake / broiler / convection bake / defrosting	
Knobs	metal coated	Main oven volume	4.7 ft ³	
Burner type	brass	Auxiliary oven type	gas conventional	
Grates	cast iron	Auxiliary oven broiler type	gas	
Continous grating	yes	Auxiliary oven functions	bake	
Thermocouple safety device	yes	Auxiliary oven volume	2.4 ft ³	
One-hand ignition	yes	Oven controls	knobs / thermometer	
Backguard	yes	Inner oven door	triple	
Wok ring	yes	Removable inner glass	yes	
Simmer ring	yes	Cooling fan	yes	
Cookinf zones		Oven levels	7	
Power burners	1300 BTU/h - 19 000 BTU/h (2)	Food probe	yes	
Rapid burner	2500 BTU/h - 10 400 BTU/h (1)	Door hinge	soft-close	
Medium burner	1500 BTU/h - 5900 BTU/h (2)	Sliding shelves	2 sets of telescopic glides	
Simmer burner	750 BTU/h - 3500 BTU/h (1)	Wire-shelves	2 each cavity	
Griddle power	1100 W	Tray	1 baking tray with grill trivet	
Griddle dual control	yes	Grill trivet for tray	yes	
Griddle drip tray	yes	Oven lights	double lateral	
		Bottom		
		Legs	stainless steel	
		Technical specifications		
		Absorbed current (A)	10 A with dedicated circuit	
		Electrical supply	110 V 60 Hz - 1200W	

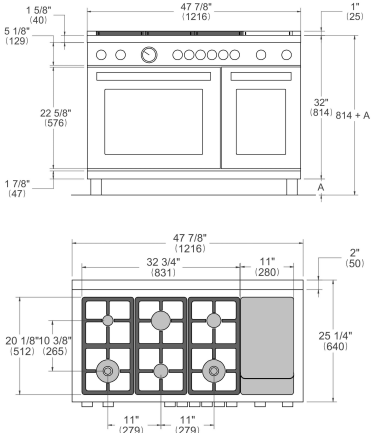

ESTUFAS SERIE HERITAGE 36"

BERTAZZONI	Código	Descripción	Color	Precio
	HER366BCFGMNET	36" Heritage Series range - Gas Oven - 6 brass burners	Negro	\$8,598
	HER366BCFGMXT	36" Heritage Series range - Gas Oven - 6 brass burners	Acero	\$8,598
	HER366BCFGMAVT	36" Heritage Series range - Gas Oven - 6 brass burners	Crema	\$8,598
Especificaciones				
Worktop		Oven Cavity		
Size	36 in	Oven configuration	single	
Cooking zones	6	Oven fuel	gas	
Gas zones	6 Burners	Oven type	fan assisted gas	
Worktop type	gas	Oven broiler type	gas	
Worktop design	stainless steel squared	Cooking modes	bake/broil/convection bake	
Worktop controls	knobs	Oven volume	5.9 ft ³	
Knobs	solid metal	Oven convection system	dual horizontal fans	
Burner type	brass	Oven controls	knobs/thermometer	
Grates	cast iron	Inner oven door	triple	
Continuous grating	yes	Removable inner glass	yes	
Thermocouple safety device	yes	Cooling fan	yes	
One-hand ignition	yes	Oven levels	7	
Backguard	yes	Food probe	yes	
Work adapter	yes	Door hinges	soft-close	
Wok ring	yes	Sliding shelves	2 set of telescopic glides	
Simmer ring	yes	Wire-shelves	2 heavy duty	
Cast iron griddle	yes	Tray	1 baking tray with grill trivet	
Cooking zones		Grill trivet for tray	yes	
Power Burners	1300 BTU/h - 19 000 BTU/h (2)	Oven lights	double lateral	
Rapid Burner	2500 BTU/h - 10 400 BTU/h (1)	Bottom		
Medium Burner	1500 BTU/h - 5900 BTU/h (2)	Legs	stainless steel	
Simmer Burner	750 BTU/h - 3500 BTU/h (1)			
Technical specifications				
Absorbed current (A)	2.5 A with dedicated circuit			
Electrical supply	110V 60 Hz - 300W			

CAMPANAS SERIE HERITAGE 36"

BERTAZZONI	Código	Descripción	Color	Precio
	KC36HERTX	36" Canopy Hood Stainless	Acero	\$1,086
	KC36HERTAV	36" Canopy Hood Ivory	Crema mate	\$1,086
	KC36HERTNE	36" Canopy Hood Nero	Negro	\$1,086
Especificaciones				
Worktop		Lights	2 LED	
Size	36 in	Hood finishing	stainless steel and matt or glossy color	
Hood		Sound rating	1.3 - 8.6 Sones	
Hood type	wallmount	Max extraction power	600 CFM	
Hood control	electronic with buttons	Technical specifications		
Duct cover	included	Electrical supply	120 V - 60 Hz - 3.30 A	
Motor	1	Power rating	400 W	
Speed	3			
Filters type	baffle stainless steel			
Motor para campana HERITAGE 36"				
K36HERTX	Motor 600 CFMS			\$2,004
*Se debe cotizar Campana más Motor.				

ESTUFAS SERIE HERITAGE 48"

BERTAZZONI	Código	Descripción	Color	Precio
	HER486BTFGMNET	48" Heritage Series range - Gas Oven - 6 brass burners + griddle	Negro	\$13,634
	HER486BTFGMXT	48" Heritage Series range - Gas Oven - 6 brass burners + griddle	Acero	\$13,634
	HER486BTFGMAVT	48" Heritage Series range - Gas Oven - 6 brass burners + griddle	Crema	\$13,634
Especificaciones				
Worktop		Oven Cavity		
Size	48 in	Oven configuration	double	
Cooking zones	7	Oven fuel	gas	
Gas zones	6 Burners	Oven type	gas conventional	
Griddle zones	electric	Oven convection system	dual horizontal fans	
Worktop type	electric / gas	Main oven type	fan assisted gas	
Worktop design	stainless steel squared	Main oven broiler type	gas	
Worktop controls	knobs	Main oven functions	bake/broiler/convection bake/defrosting	
Knobs	solid metal	Main oven volume	4.7 ft ³	
Burner type	brass	Auxiliary oven type	gas conventional	
Grates	cast iron	Auxiliary oven broiler type	gas	
Continuous grating	yes	Auxiliary oven functions	bake	
Thermocouple safety device	yes	Auxiliary oven volume	2.4 ft ³	
One-hand ignition	yes	Oven controls	knobs/thermometer	
Backguard	yes	Inner oven door	triple	
Wok ring	yes	Removable inner glass	yes	
Simmer ring	yes	Cooling fan	yes	
Cooking zones		Oven levels	7	
Power burners	1300 BTU/h - 19 000 BTU/h (2)	Food probe	yes	
Rapid burner	2500 BTU/h - 10 400 BTU/h (1)	Door hinges	soft-close	
Medium burner	1500 BTU/h - 5900 BTU/h (2)	Sliding shelves	2 sets of telescopic glides	
Simmer burner	750 BTU/h - 3500 BTU/h (1)	Wire-shelves	2 each cavity	
Griddle power	1100 W	Tray	1 baking tray with grill trivet	
Griddle dual control	yes	Grill trivet for tray	yes	
Griddle drip tray	yes	Oven lights	double lateral	
Technical specifications		Bottom		
Absorbed current (A)	10 A with dedicated circuit	Legs	stainless steel	
Electrical supply	110V 60 Hz - 1200W			

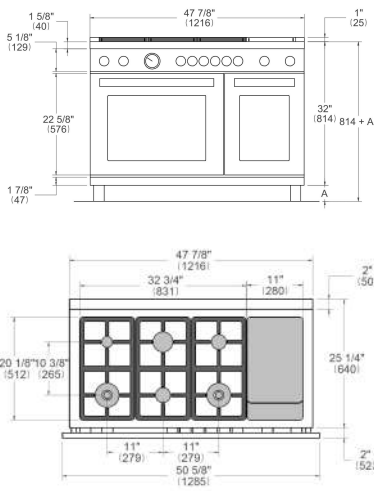

CAMPANAS SERIE HERITAGE 48"

BERTAZZONI	Código	Descripción	Color	Precio
	KC48HERTX	48" Canopy Hood Stainless	Acero	\$1,349
	KC48HERTAV	48" Canopy Hood Ivory	Crema mate	\$1,349
	KC48HERTNE	48" Canopy Hood Nero	Negro mate	\$1,349
Especificaciones				
Worktop		Lights	2 LED	
Size	48 in	Hood finishing	stainless steel and matt or glossy color	
Hood		Sound rating	1.3 - 8.6 Sones	
Hood type	wallmount	Max extraction power	600 CFM	
Hood control	electronic with buttons	Technical specifications		
Duct cover	included	Electrical supply	120 V - 60 Hz - 3.30 A	
Motor	1	Power rating	400 W	
Speed	3			
Filters type	baffle stainless steel			
Motor para campana HERITAGE 36"				
K48HERTX	Motor 600 CFMS			\$2,178
*Se debe de cotizar campana + motor.				



ACCESORIOS OPCIONALES ESTUFAS

DECOR SET PARA CAMPANA Y ESTUFA HERITAGE 36" - 48"		
Código	Descripción	Precio
DSHERTKHGO	Decor Set 1- Range & Hood Kit : Gold Finish	\$1,919
DSHERTKHPC	Decor Set 1- Range & Hood Kit : Polished Copper Finish	\$1,919
DSHERTKHSB	Decor Set 1- Range & Hood Kit : Matt Satin Black Finish	\$1,919



DECOR SET PARA ESTUFAS MASTER 36" - 48"		
Código	Descripción	Precio
DSMASGKSG	10 x knobs in Gold	\$1,154
DSMASGKSB	10 x knobs in Black Nickel	\$1,154
DSMASHSG	2 x handle finials in Gold	\$385
DSMASHSB	2 x handle finials in nickel	\$385

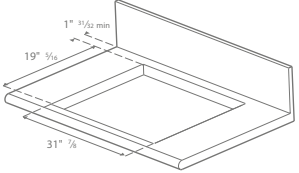
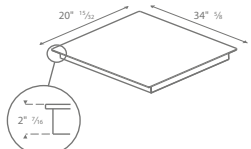

PARRILLAS DE INDUCCIÓN PROFESSIONAL SERIES

BERTAZZONI	Código	Descripción	Precio
  	P365IAE	36" - 5 Induction Zones Cooktop Professional Series	\$4,888
	Especificaciones		
Worktop		Cooking zones	
Size	36 in	Induction 2 bridge zones	yes
Cooking zones	5	Induction front left	(=8 3/4 in) 2 100 W - 3 700 W
Induction zones	5	Induction back left	(=8 3/4 in) 2 100 W - 3 700 W
Worktop type	induction	Induction center	(=12 in) 2 600 W - 5 500 W
Worktop design	ceramic glass bevelled	Induction front right	(=8 3/4 in) 2 100 W - 3 700 W
Worktop controls	touch controls	Induction back right	(=8 3/4 in) 2 100 W - 3 700 W
		Technical specifications	
		Electrical supply	208/240 V - 50/60 Hz - 48 A
		Power rating	11 100 W

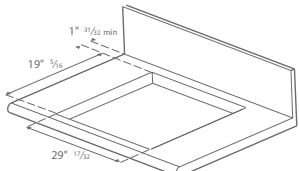
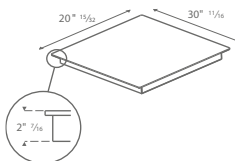
BERTAZZONI	Código	Descripción	Precio
  	P304IAE	30" - 4 Induction Zones Cooktop Professional Series	\$3,666
	Especificaciones		
Worktop		Cooking zones	
Size	30 in	Induction front left	(=8 3/4 in) 2 100 W - 3 700 W
Cooking zones	4	Induction back left	(=8 3/4 in) 2 100 W - 3 700 W
Induction zones	4	Induction front right	(=9 1/4 in) 2 100 W - 3 700 W
Worktop type	induction	Induction back right	(=11 1/4 in) 2 600 W - 3 700 W
Worktop design	ceramic glass bevelled		
Worktop controls	touch controls		
		Technical specifications	
		Electrical supply	208/240 V - 50/60 Hz - 32 A
		Power rating	7 400 W



PARRILLAS ENCIMERAS DE GAS BERTAZZONI

BERTAZZONI	Código	Descripción	Color	Precio
	P905Cprox	90cm Gas on steel Cooktop, 5 Brass Burners	Acero	\$1,184
	Especificaciones			
	Worktop		Cooking zones	
	Size	90 cm	Front right	1 auxiliary 0.48 kW - 1.00 kW
	Worktop surface	stainless steel	Back right	1 rapid 1.05 kW - 3.00 kW
	Layout	5 burners	Center	1 wok dual 0.48 kW - 5.00 kW
	Worktop controls	knobs	Front left	1 semi-rapid 0.60 kW - 1.75 kW
	Knobs	metal	Back left	1 semi-rapid 0.60 kW - 1.75 kW
	Pan supports	cast iron	Technical specifications	
	Burner type	brass	Electrical requirements	220/240, 50/60 Hz, 1A, 1W
Work burner	5 kW dual			
Flame failure device	-			
One-hand ignition	-			
Standard accessories	-			

PARRILLAS DE GAS

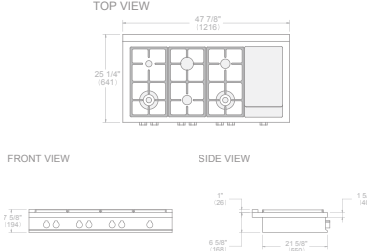
BERTAZZONI	Código	Descripción	Color	Precio
 	PROF486GRTBXT	48" Rangetop 6 Brass Burners + Griddle Professional Series	Acero	\$4,006
	Especificaciones			
	Worktop		Cooking zones	7
	Size	48 in	Griddle zones	electric
	Maintop	6 burners + stainless steel griddle with cover	Worktop type	electric/gas
	Burner power	2 power burners 19000 BTU 1 rapid burner 10400 BTU 2 medium burners 5900 BTU 1 simmer burner 3500 BTU	Worktop desing	stainless steel squared
			Knobs	solid metal
			Burner type	brass
	Ignition system	Electric with thermocouple safety device	Technical specifications	
	Grates	Cast iron	Electrical requirements	120 V - 60 Hz - 10 A
		Power rating	1100 W	

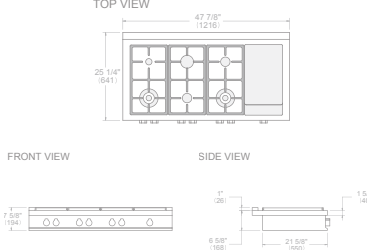
BERTAZZONI	Código	Descripción	Color	Precio
 	MAST486GRTBXT	48" Rangetop 6 Brass Burners + Griddle Master Series	Acero	\$4,006
	Especificaciones			
	Worktop		Cooking zones	7
	Size	48 in	Griddle zones	electric
	Maintop	6 burners + stainless steel griddle with cover	Worktop type	electric/gas
	Burner power	2 power burners 19000 BTU 1 rapid burner 10400 BTU 2 medium burners 5900 BTU 1 simmer burner 3500 BTU	Worktop desing	stainless steel squared
			Knobs	solid metal
			Burner type	brass
	Ignition system	Electric with thermocouple safety device	Technical specifications	
	Grates	Cast iron	Electrical requirements	120 V - 60 Hz - 10 A
		Power rating	1100 W	

BERTAZZONI	Código	Descripción	Color	Precio
 	PROF366RTBXT	36" Rangetop 6 Brass Burners Professional Series	Acero	\$2,616
	Especificaciones			
Worktop		Cooking zones	6	
Size	36 in	Griddle zones	electric	
Maintop	6 burner	Worktop type	electric/gas	
Burner power	2 power burners 19000 BTU 1 rapid burner 10400 BTU 2 medium burners 5900 BTU 1 simmer burner 3500 BTU	Worktop desing	stainless steel	
		Knobs	solid metal	
		Burner type	brass	
Ignition system	Electric with thermocouple safety device	Technical specifications		
Grates	Cast iron	Electrical requirements	120 V - 60 Hz - 1 A	
		Power rating	1 W	

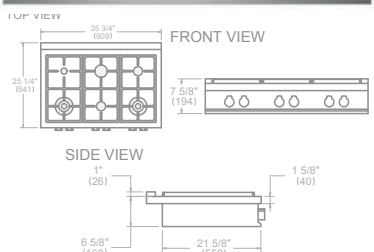
BERTAZZONI	Código	Descripción	Color	Precio
 	MAST366RTBXT	36" Rangetop 6 Brass Burners Master Series	Acero	\$2,616
	Especificaciones			
Worktop		Cooking zones	6	
Size	36 in	Griddle zones	electric	
Maintop	6 burner	Worktop type	electric/gas	
Burner power	2 power burners 19000 BTU 1 rapid burner 10400 BTU 2 medium burners 5900 BTU 1 simmer burner 3500 BTU	Worktop desing	stainless steel	
		Knobs	solid metal	
		Burner type	brass	
Ignition system	Electric with thermocouple safety device	Technical specifications		
Grates	Cast iron	Electrical requirements	120 V - 60 Hz - 1 A	
		Power rating	0.01 W	



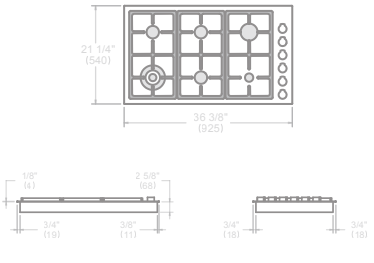

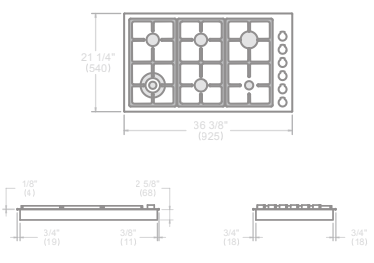
BERTAZZONI	Código	Descripción	Color	Precio
 	MAST366QBXT	36" Built-in cooktop master series	Acero	\$1,863
	Especificaciones			
Worktop			Cooking zones	6
Size	36 in		Griddle zones	electric
Maintop	6 burner		Worktop type	electric/gas
Burner power	1 power burners 17000 BTU 1 rapid burner 10400 BTU 3 medium burners 6000 BTU 1 simmer burner 3750 BTU		Worktop desing	stainless steel
			Knobs	solid metal
			Burner type	brass
Technical specifications				
Ignition system	Electric with thermocouple safety device		Electrical requirements	120 V - 60 Hz - 1 A
Grates	Cast iron		Power rating	1 W

BERTAZZONI	Código	Descripción	Color	Precio
 	PROF366QBXT	36" Built-in cooktop professional series	Acero	\$1,863
	Especificaciones			
Worktop			Cooking zones	6
Size	36 in		Griddle zones	electric
Maintop	6 burner		Worktop type	electric/gas
Burner power	1 power burners 17000 BTU 1 rapid burner 10400 BTU 3 medium burners 6000 BTU 1 simmer burner 3750 BTU		Worktop desing	stainless steel
			Knobs	solid metal
			Burner type	brass
Technical specifications				
Ignition system	Electric with thermocouple safety device		Electrical requirements	120 V - 60 Hz - 1 A
Grates	Cast iron		Power rating	0.01 W



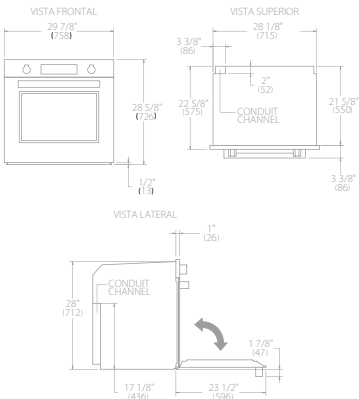

HORNOS CONVECCIÓN 30"

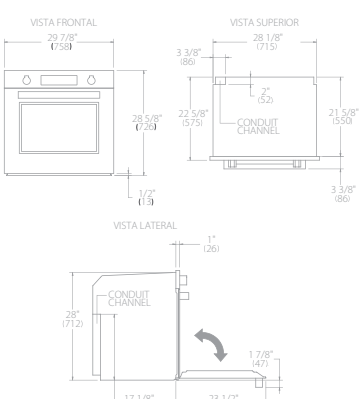
BERTAZZONI	Código	Descripción	Color	Precio
 	PROF30FSEXT	30" Single Convection Oven Top Version Profesional Series	Acero	\$5,421
	Especificaciones			
Worktop		Cavity finishing	pyrolytic grey enamel	
Size	30 in	Oven handle	metal	
Oven configuration	single	Cooling fan	yes	
Oven fuel	electric	Oven levels	7	
Oven type	self-clean	Timer	touch digital programmer	
Oven broiler type	electric	Auto cooking modes	33 preset / with assistant	
Oven functions	bake / broiler / convection / convection bake / convection broiler / defrosting / dehydrate / proofing / pyrolytic self clean / turbo / warming	Door hinge	soft-motion	
Overall volume	4.10 ft ³	Sliding shelves	1 full extension	
		Wire-shelves	2 heavy gauge chromed	
Oven convection system	dual diagonal with heating element	Tray	1 enamelled	
		Grill trivet for tray	yes	
Oven controls	knobs / touch LCD hi res display	Oven lights	double	
Inner oven door	quadruple	Technical specifications		
Removable inner glass	yes	Electrical requirements	120/240 Vac - 60 Hz - 30 A	
		Power rating	5400 W	

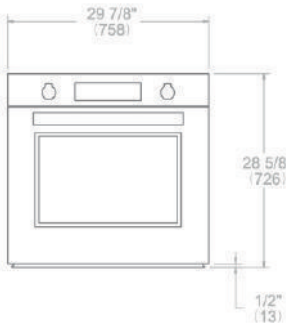
BERTAZZONI	Código	Descripción	Color	Precio
 	MAST30FSEXT	30" Single Convection Oven Top Version Master Series	Acero	\$5,421
	Especificaciones			
Worktop		Oven handle	metal	
Size	30 in	Cooling fan	yes	
Oven configuration	single	Oven levels	7	
Oven fuel	electric	Timer	touch digital programmer	
Oven type	self-clean	Door hinge	soft-close	
Oven broiler type	electric	Wire-shelves	2 heavy gauge chromed	
Oven functions	bake / broiler / convection / convection bake / convection broiler / defrosting / dehydrate / proofing / pyrolytic self clean / turbo / warming	Tray	1 enamelled	
Overall volume	4.10 ft ³	Grill trivet for tray	yes	
		Oven lights	single	
Oven convection system	dual diagonal with heating element	Technical specifications		
Oven controls	knobs / touch LED display	Electrical requirements	120/240 V - 60 Hz - 30 A	
Inner oven door	quadruple	Power rating	5400 W	
Removable inner glass	yes			
Cavity finishing	pyrolytic grey enamel			

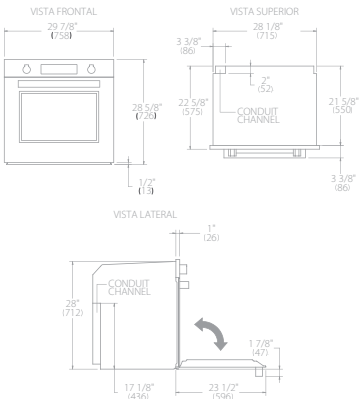
BERTAZZONI	Código	Descripción	Color	Precio
 	PROF30FSEXV	30" Single Convection Oven Value Version Profesional Series	Acero	\$4,035
	Especificaciones			
Worktop		Oven handle	metal	
Size	30 in	Cooling fan	yes	
Oven configuration	single	Oven levels	7	
Oven fuel	electric	Timer	touch digital programmer	
Oven type	self-clean	Door hinge	soft-motion	
Oven broiler type	electric	Wire-shelves	1 flat / 1 shaped	
Oven functions	bake / broil / convection / convection bake / convection broil / defrosting / dehydrate / proofing / pyrolytic self clean / pizza / sabbath mode / warming	Tray	1 baking tray whit roasting trivet	
Overall volume	4.10 ft ³	Grill trivet for tray	yes	
Oven convection system	dual diagonal with heating element	Oven lights	single	
Oven controls	knobs / touch LED display	Technical specifications		
Inner oven door	quadruple	Electrical requirements	120/240 V - 60 Hz - 30 A	
Removable inner glass	yes	Power rating	5400 W	
Cavity finishing	pyrolytic grey enamel			

BERTAZZONI	Código	Descripción	Color	Precio
 	MAST30FSEXV	30" Single Convection Oven Value Version Master Series	Acero	\$4,035
	Especificaciones			
Worktop		Oven handle	metal	
Size	30 in	Cooling fan	yes	
Oven configuration	single	Oven levels	7	
Oven fuel	electric	Timer	touch digital programmer	
Oven type	self-clean	Door hinge	soft-motion	
Oven broiler type	electric	Wire-shelves	2 heavy gauge chromed	
Oven functions	bake / broil / convection / convection bake / convection broil / pizza / defrost / dehydrate / fast preheat / keep warm / light / proof / self clean / timer	Tray	1 enamelled	
Overall volume	4.10 ft ³	Grill trivet for tray	yes	
Oven convection system	dual diagonal with heating element	Oven lights	single	
Oven controls	knobs / touch LED display	Technical specifications		
Inner oven door	quadruple	Electrical requirements	120/240 V - 60 Hz - 30 A	
Removable inner glass	yes	Power rating	5400 W	
Cavity finishing	pyrolytic grey enamel			

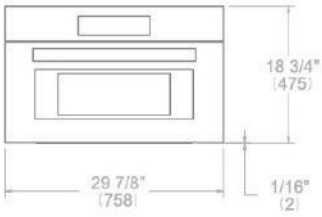
BERTAZZONI	Código	Descripción	Color	Precio
 	PROF30SOEX	30" Convection Speed Oven Profesional Series	Acero	\$3,083
	Especificaciones			
Worktop		Oven handle	metal	
Size	30 in	Microwave power	200 / 400 / 600 / 800 / 1000	
Oven configuration	single	Oven levels	2	
Oven fuel	electric	Timer	yes	
Oven type	self-clean	Door hinge	soft-motion	
Oven broiler type	electric	Wire-shelves	1 flat / 1 shaped	
Oven functions	broil / convection / microwave / convection broil / microwave whit broiler/ pizza / defrost by time / defrost by weight / light / popcorn / recipes / timer	Tray	1 glass	
Overall volume	1.34 ft ³	Grill trivet for tray	yes	
Oven convection system	single whit ring heating element	Oven lights	single	
Oven controls	touch LED display	Technical specifications		
Inner oven door	double	Electrical requirements	120/240 V - 60 Hz - 16 A	
Removable inner glass	yes	Power rating	1500 W	
Cavity finishing	stainless steel			

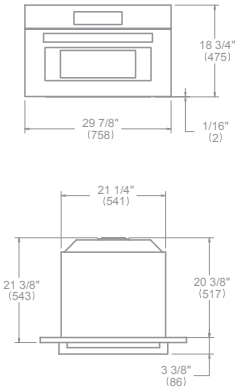
BERTAZZONI	Código	Descripción	Color	Precio
 	MAST30SOEX	30" Convection Speed Oven Master Series	Acero	\$3,083
	Especificaciones			
Worktop		Oven handle	metal	
Size	30 in	Microwave power	200 / 400 / 600 / 800 / 1000	
Oven configuration	single	Oven levels	2	
Oven fuel	electric	Timer	yes	
Oven type	self-clean	Door hinge	soft-motion	
Oven broiler type	electric	Wire-shelves	1 flat / 1 shaped	
Oven functions	broil / convection / microwave / convection broil / microwave whit broiler/ pizza / defrost by time / defrost by weight / light / popcorn / recipes / timer	Tray	1 glass	
Overall volume	1.34 ft ³	Grill trivet for tray	yes	
Oven convection system	single whit ring heating element	Oven lights	single	
Oven controls	touch LED display	Technical specifications		
Inner oven door	double	Electrical requirements	120/240 V - 60 Hz - 30 A	
Removable inner glass	yes	Power rating	1500 W	
Cavity finishing	stainless steel			

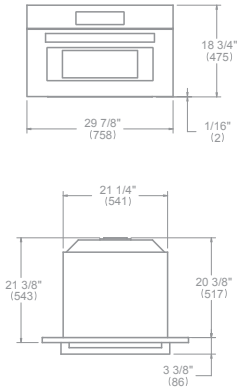
BERTAZZONI	Código	Descripción	Color	Precio
 	PROF30CSEX	30" Convection Steam Oven Profesional Series	Acero	\$3,214
	Especificaciones			
Worktop		Oven handle	metal	
Size	30 in	Shelf levels	2	
Oven configuration	single	Door hinges	soft-motion	
Oven fuel	electric	Removable water tank	33.8 fl.oz	
Oven type	combination electric			
Oven broiler type	convection and steam			
Oven broiler type	electric			
Oven functions	broil / convection / convection broil / convection steam / steam only / descale / light / recipes / reheat / sterilize / timer / water hardness / setting			
Overall volume	1.34 ft ³	Technical specifications		
Oven convection system	1 fan	Electrical requirements	240 V - 60 Hz - 16 A	
Oven controls	touch LED display	Power rating	3200 W	
Inner oven door	double			
Removable inner glass	yes			
Cavity finishing	stainless steel			

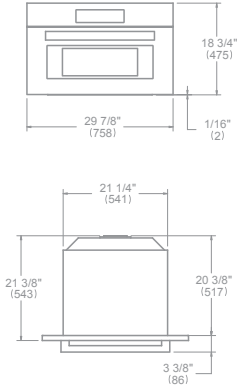
BERTAZZONI	Código	Descripción	Color	Precio
 	MAST30CSEX	30" Convection Steam Oven Master Series	Acero	\$3,214
	Especificaciones			
Worktop		Oven handle	metal	
Size	30 in	Shelf levels	2	
Oven configuration	single	Door hinges	soft-motion	
Oven fuel	electric	Removable water tank	33.8 fl.oz	
Oven type	combination electric			
Oven broiler type	convection and steam			
Oven broiler type	electric			
Oven functions	broil / convection / convection broil / convection steam / steam only / descale / light / recipes / reheat / sterilize / timer / water hardness / setting			
Overall volume	1.34 ft ³	Technical specifications		
Oven convection system	1 fan	Electrical requirements	240 V - 60 Hz - 30 A	
Oven controls	touch LED display	Power rating	3200 W	
Inner oven door	double			
Removable inner glass	yes			
Cavity finishing	stainless steel			

HORNO CONVECCIÓN 24"

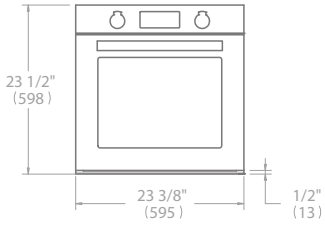
BERTAZZONI	Código	Descripción	Color	Precio
 	PROF24FSEXV	24" Electric Convection Oven Professional Series	Acero	\$1,587
	Especificaciones			
Worktop		Cavity finishing	black enamel	
Size	24 in	Oven handle	metal	
Oven configuration	Single	Cooling fan	yes	
Oven fuel	Electric	Oven levels	5	
Oven broiler type	Electric	Timer	touch digital programmer	
Cooking modes	bake / bottom bake / broil / convection / convection bake / convection broil / defrosting dehydrate / fast preheat / oven light / pizza / proofing turbo / upper bake	Door hinges	soft-motion	
		Wire-shelves	1 flat / 1 shaped	
		Tray	1 baking tray with roasting trivet	
Technical specifications				
Gross volume oven	2.70 ft ³	Electrical supply	120/240 V 60 Hz - 2800 W 208/240 V 60 Hz - 2100 W 16 Amp dedicated circuit	
Oven convection system	single	Power rating	Bake: 2050 W / Broiler: 2400 W / Convection: 1800 W	
Oven controls	knobs / touch LED display	Power connection	metal conduit 59" power cord	
Inner oven door	triple	Certification	UL	
Removable inner glass	yes			

MICROONDAS

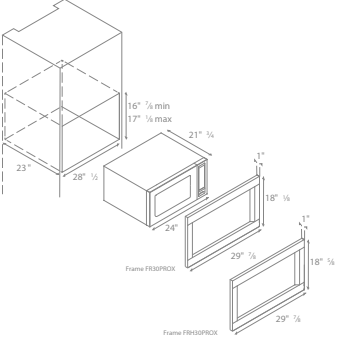
BERTAZZONI	Código	Descripción	Color	Precio
 	MO30STANE/16	30" Microwave Oven	Acero	\$1,197
	Especificaciones			
Worktop		Sensor reheat, defrost, cook	yes	
Size	30 in	Clock/Timer	yes	
Overall volume	2.00 ft ³	Cook time function	yes	
Cavity finishing	Enameled white	Child lock	yes	
Microwave power levels	10 Levels	Turnspit	1 Ø 16	
Preset cooking mode functions	yes	Technical specifications		
Multiple sequence cooking	4	Electrical requirements	120 V - 60 Hz - 10 A	
		Power rating	1100 W	

TRIMS

BERTAZZONI	Código	Descripción	Color	Precio
	FR30PROX	30" Built-in Trim for MO30STANE	Acero	\$313
	Especificaciones			
Size	30 in	Type	Built-in Installation of MO30STANE 24" Microwave	
Finishing	stainless steel			

BERTAZZONI	Código	Descripción	Color	Precio
	PROF24SOEX	24" - Convection Speed Oven Professional Series	Acero	\$2,639
	Especificaciones			
Worktop		Grill trivet for tray	yes	
Special functions	defrost by time / defrost by weight / light / popcorn / recipes timer	Turntable quantity	1 glass	
Size	24 in			
Microwave type	combi-microwave			
Functions	broil / convection / microwave / convection broil microwave / microwave with broiler / pizza			
Technical specifications				
Total volume	1.34 ft ³	Electrical supply	240 V - 60 HZ - 3850 W / 16 Amp dedicated circuit	
Oven convection system	single	Broiler:	1500 W / Convection: 1600 W	
Oven controls	touch LED display	Power connection	NEMA 6-20P with 71" power cord	
Auto cooking modes	yes	Certification	CETLUS	
Inner oven door	double			
Removable inner glass	yes			
Cavity finishing	stainless steel			
Oven levels	2			
Microwave power levels	200 / 400 / 600 / 800 / 1000			
Clock/Timer	yes			
Tray	1 glass			

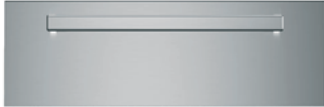
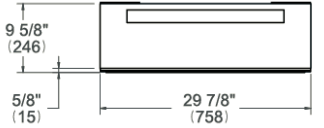

CAJONES CALIENTES

BERTAZZONI	Código	Descripción	Color	Precio
 	PROF30WDEX	30" Convection Warming Drawer	Acero	\$1,520
	Especificaciones			
Worktop		Technical specifications		
Size	30 in	Electrical supply	120 V - 60 Hz - 500 W 5 Amps	
Design	Stainless steel	Power connection	NEMA 5-15P with 59" power cord	
Volume	2.3 cu ft	Certification	CETLUS	
Cavity finishing	Tempered glass bottom	Packaging dimensions and weight	W 26 3/8" H 13 1/2" D 32 3/4" 87.3 lbs	
Temperature range	85 - 170 °F			

BERTAZZONI	Código	Descripción	Color	Precio
 	MAST30WDEX	30" Convection Warming Drawer	Acero	\$1,520
	Especificaciones			
Worktop		Technical specifications		
Size	30 in	Electrical supply	120 V - 60 Hz - 500 W 5 Amps	
Design	Stainless steel	Power connection	NEMA 5-15P with 59" power cord	
Oven Volume	2.3 cu ft	Certification	CETLUS	
Cavity finishing	Tempered glass bottom	Packaging dimensions and weight	W 26 3/8" H 13 1/2" D 32 3/4" 87.3 lbs	
Temperature range	85 - 170 °F			

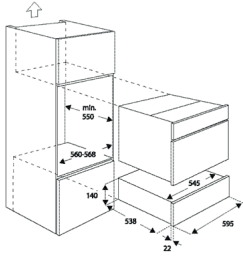
BERTAZZONI	Código	Descripción	Color	Precio
 	WD60PROX	24" Warming Drawer Professional Series	Acero	\$1,080
	Especificaciones			
Worktop		Technical specifications		
Size	24 in	Voltage and frequency	220/240 V - 50/60 Hz	
Design	Stainless steel	Absorbed power (W)	400 W	
Controls	push/pull with soft motion operation	Equipment	inner rubber matt / thermostat light on/off	
Carring capacity	25kg			
Max temperature	85°C			

CAMPANA

BERTAZZONI	Código	Descripción	Color	Precio
	KIN36XV	36" - Insert Hood, 1 motors 560 CFM Professional Series	Acero	\$1,257
	Especificaciones			
Hood		Technical specifications		
Size	36 in	Electrical supply	110 V - 60 Hz - 3.30 A	
Hood type	built-in	Power rating	410 W	
Hood control	electronic with buttons	Power connection	NEMA 5-15P with 59" power cord	
Motor	1	Certification	CEC, UL	
Speed	3 + booster			
Filters type	aluminum mesh			
Lights	2 LED			
Hood finishing	stainless steel			
Duct size	6" diameter			
Sound rating	1.5 - 6 Sones			
Max extraction power	560 CFM			

LAVAVAJILLAS

BERTAZZONI	Código	Descripción	Color	Precio
	DW24T3IPV	24" - Dishwasher Tall Tub Panel Ready, Professional Series	Acero	\$1,975
	Especificaciones			
Worktop		Technical specifications		
Size	24 in	Delayed start	yes	
Place setting	15	Lighting	floor projection status light	
Controls	concealed multi-button	Drying system	PowerDry Plus	
Interior finish	stainless steel	Overflow protection device	yes	
User interface	LED display	Filter system	triple stage metal filter	
Spray arms	3	Certification	CEC, NSF, UL	
Number of racks	3			
Cutlery basket	sliding	Electrical supply	120 V - 60 Hz - 12 A	
Wash cycle	6 - auto, crystal and china, pots and pans, quick, regular, rinse and hold	Power rating	1400 W	
Wash Options	7 - accel, extra dry, delay start, 3 half load modes, sanitize, scrub, stealth	Energy consumption	234 kWh	
Accesorios				
HK24PRODWX	Handle Kit for 24 Dishwasher Professional series			\$154
HK24MASDWX	Handle Kit for 24 Dishwasher Master Series			\$154
HK24HERDWX	Handle Kit for 24 Dishwasher Heritage Series			\$154