

indoor comfort,
outdoor living.

INFRATECH
COMFORT

PREMIUM OUTDOOR COMFORT HEAT

HOMEA
PREMIUM

HOMEA

www.homea.mx

Email: ventas@homea.mx

Whatsapp: (442)258.0251

Tel: (442)216.3552

Lada sin Costo: 01(800)701.2121



bring more living to
your outdoor spaces.

HOMEA
PREMIUM

HOMEA

www.homea.mx

Email: ventas@homea.mx

Whatsapp: (442)258.0251

Tel: (442)216.3552

Lada sin Costo: 01(800)701.2121



Brunch on the terrace in early spring. Holiday cocktails on the deck. Now you can extend the outdoor living and entertaining season by more than three months in temperate areas to year-round in milder climates with an Infratech electric heating system. Our products offer eco-friendly, customized warmth that enhances the comfort of your outdoor spaces. Choose from a versatile range of options, to seamlessly blend into the design of your home or commercial property. All Infratech products are proudly made in the USA.

CONTENTS

INFRARED BASICS

Dial up the comfort – without harming the environment.

4-5



PRODUCTS

Bring year-round indoor comfort to an outdoor living space.

6-17



INSTALLATION

Versatile options. Zone heaters for energy efficiency.

18-27



eco-friendly, emission-free, *ambient warmth.*

Discover a sustainable comfort heat source for outdoor living and entertaining spaces. Infratech electric heaters are over 90% energy efficient, operate for just pennies per hour, and emit a subtle, pleasing glow that will not blow away in windy conditions. Enjoy odorless, radiant warmth that won't detract from the aroma of an al fresco meal in the outdoor kitchen or interfere with the view from a rooftop deck.

HOW INFRA TECH HEATING WORKS

☺☺☺ Heated quartz elements emit a safe, clean wavelength of light that is only absorbed by solid objects, transferring heat directly to a person, table or floor rather than heating the air

☁ Infrared heat doesn't "blow away" in windy conditions, making it ideal for breezy areas where air cannot be contained

☺☺☺ Unlike competitive short wave heaters, Infratech's medium wave quartz elements operate without any harsh glares



Energy-efficient
comfort heat with
all the ambience —
and zero emissions.



Why Infratech is the sustainable heating choice

INFRATECH ELECTRIC INFRARED HEATERS

- ✔ Convert over 90% of input energy directly into radiant heat
- ✔ Operate with zero greenhouse gases or odors and are UL Listed
- ✔ Have no refillable tanks
- ✔ Have minimal clearance requirements
- ✔ Are less expensive to purchase and operate than traditional outdoor heating options
- ✔ Are virtually maintenance-free
- ✔ Offer infinite heat intensity control and zoning capabilities with timer and remote options
- ✔ Emit a pleasing, ambient glow

TRADITIONAL GAS-FIRED HEATERS & OUTDOOR FIREPLACES

- ✘ Are often less than 50% efficient
- ✘ Emit carbon monoxide and hazardous gases from fuel combustion and require ventilation
- ✘ Require refills of propane tanks or wood
- ✘ Feature larger profiles
- ✘ Cost more to acquire and maintain
- ✘ Have many costly replacement parts
- ✘ Provide little to no heat control
- ✘ Produce smoke that can be hazardous in drought-prone regions or windy conditions

the right heaters *for every project.*

Outdoor living spaces come in all sizes, styles and layouts. With Infratech, you can choose the heater profiles, sizes and capacities to add premium comfort to any space. Our heaters can bring optimal comfort to a single room or expansive property. Infratech is a partner of choice among leading architects, interior designers and engineers because we offer a broad range of heating system options to complement their vision.



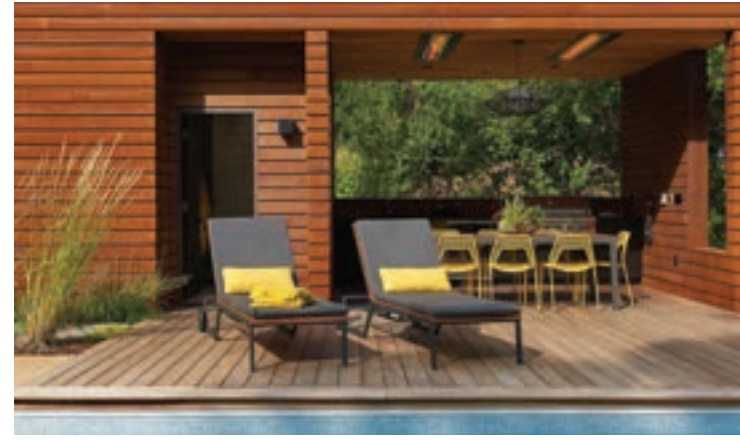

We offer heater profiles, sizes and capacities that add ideal comfort to large or small spaces, with high or low ceilings and in sheltered or exposed areas.

INFRA TECH ELECTRIC HEATERS HAVE A SMALLER, SLEEKER PROFILE THAN TYPICAL GAS INFRARED HEATERS

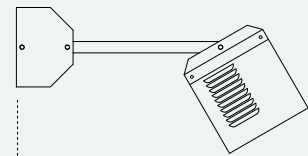

TYPICAL GAS INFRARED HEATER

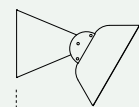

INFRA TECH W-SERIES AND WD-SERIES HEATERS

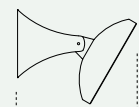

INFRA TECH C-SERIES AND CD-SERIES HEATERS

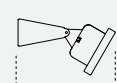

INFRA TECH SL-SERIES SLIMLINE HEATER

comfort and style
meet convenience.



MOUNTING OPTIONS

Our heaters can be flush mounted, ceiling mounted, wall mounted or pole mounted. They have minimal clearance requirements, and are UL Listed for as low as six feet. All of our mounting options are easy to install.

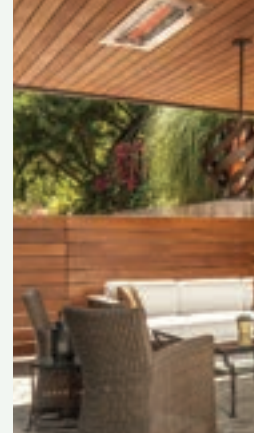

With smaller, sleeker profiles than typical gas infrared heaters, Infratech electric heating systems offer a streamlined, yet effective heating solution for any outdoor space.

1500-6000

wattage range with mounting heights up to 12 feet

ZERO

noise, odor, or greenhouse gases

EIGHT

standard colors with unlimited custom colors



C-Series

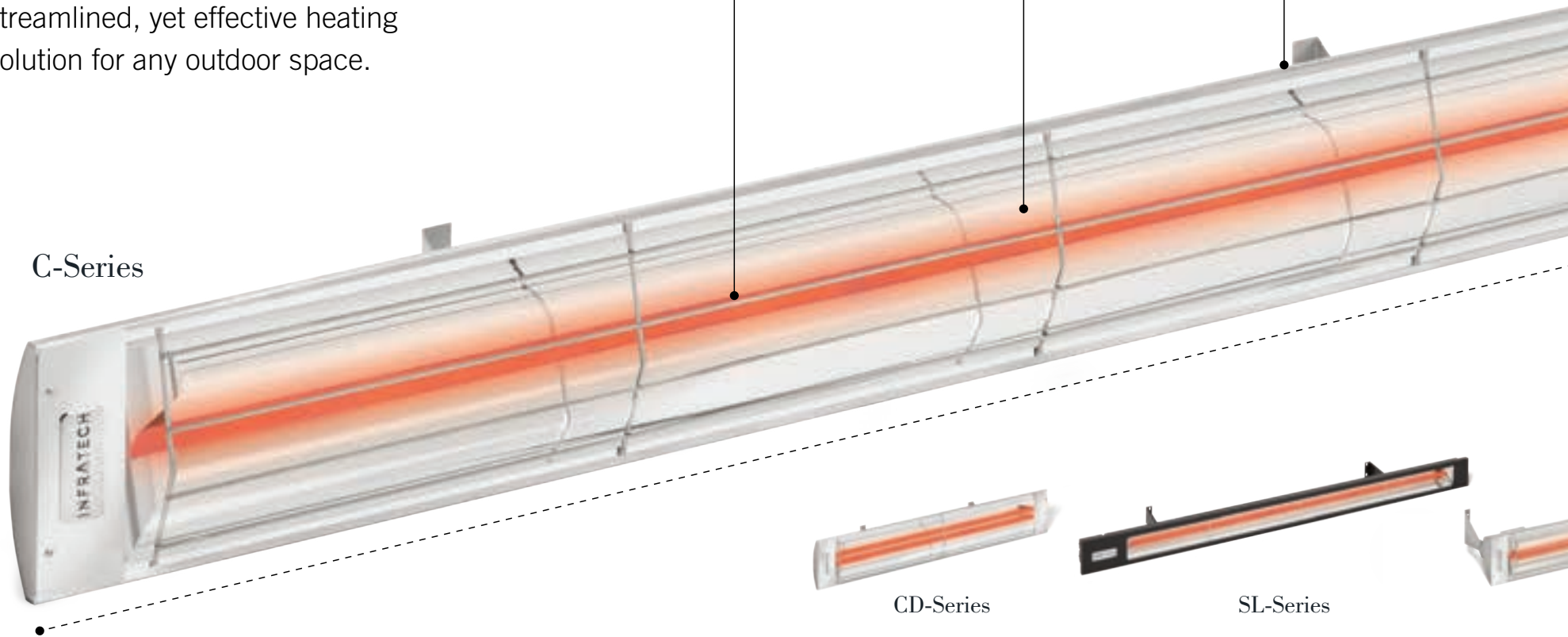

CD-Series

SL-Series



FLUSH MOUNT



CEILING MOUNT



WALL MOUNT



POLE MOUNT

CONTROL OPTIONS

Our custom control options can be fully integrated with virtually any 120V lighting dimmer including Bluetooth®, voice command capabilities, and home management systems. Infratech also offers an assortment of value controls to help you enjoy efficient ease of use that's compatible with any budget.

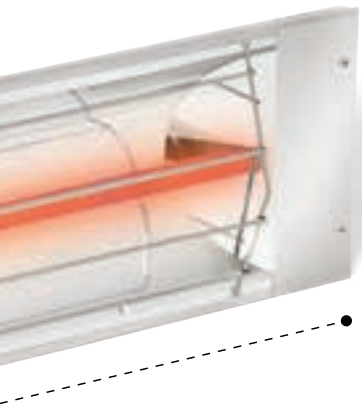

29.5"-63.5"

length options to fit any installation

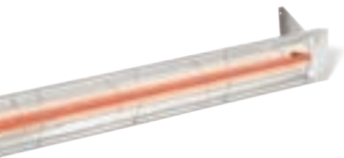

W-Series

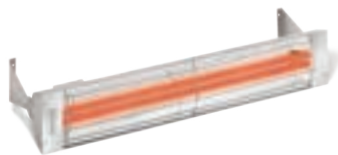

WD-Series



Timer

0-100%
intensity control

Zoning
to operate multiple heaters

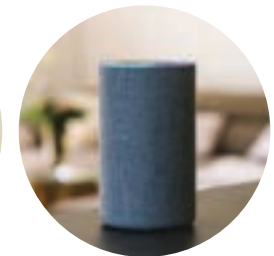

Smart Home Integration



an array of *choices.*

From backyard patios to sprawling mega-resorts, our product offerings include a range of designs, sizes, and heating capacities, to provide appropriate warmth for any property.

C-SERIES SINGLE ELEMENT HEATERS



- Our C-Series fixtures are developed for use in high visual impact locations where their sleek design blends seamlessly. They offer significant heat output for mounting heights of 6-10 feet.
- Features include: durable 304 stainless steel construction, recessed installations, and inset mounting brackets that create a “floating” effect when mounted.
- Choose from 1,500-4,000 watt and 120-480 volt capacities.
- Compatible with our custom controls for larger-scale residential or commercial use.
- Choose from brushed stainless steel, standard colors, or custom color finish options.

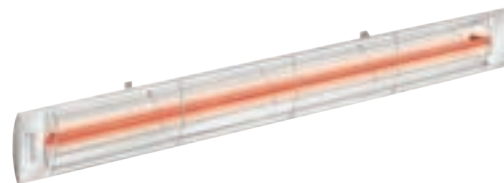

CD-SERIES DUAL ELEMENT HEATERS



- Our powerful dual-element CD-Series fixtures provide concentrated heat for larger scale applications in high visual impact locations. Designed for mounting heights of 7-12 feet.
- Features Include: durable 304 stainless steel construction, recessed installations, and inset mounting brackets that create a “floating” effect when mounted.
- Choose from 3,000-6,000 watt and 208-480 volt capacities.
- Typically installed with our custom controls, to vary the electric load for comfortable heat in a wide range of conditions.
- May also be installed with Duplex/Stack Switches for effectively a half-power or full-power option.

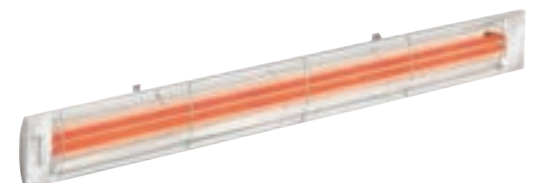

SL-SERIES SLIMLINE SINGLE ELEMENT HEATERS



- Sleek, streamlined Slimline single element heaters are ideal for surface mount applications up to 10 feet.
- Features include: modern styling, brushed stainless steel trim, narrow profile, and a T-slot for flexible mounting options.
- Choose from 1,600 watt, 2,400 watt, 3,000 watt or 4,000 watt capacities.
- Available in durable anodized aluminum housing finishes (Silver and our all-black Slimline Shadow™) that are capable of withstanding years of outdoor use.

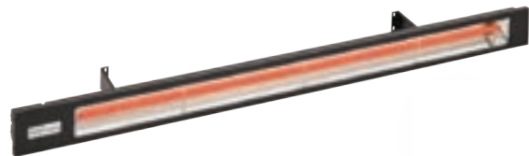

W-SERIES SINGLE ELEMENT HEATERS



- Our classic W-Series fixtures are ideal for most basic installations.
- Features include: durable 304 stainless steel construction, minimal clearance requirements, recessed mounting options, short standoffs and mounting heights between 6-10 feet.
- Choose from 1,500-4,000 watt and 120-480 volt capacities.
- Compatible with our custom controls for larger-scale residential or commercial use.
- Choose from brushed stainless steel, standard colors, or custom color finish options.

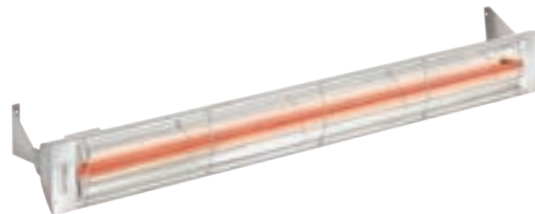

WD-SERIES DUAL ELEMENT HEATERS



- High-powered, dual-element WD-Series fixtures provide more concentrated heat for recessed installations, premium outdoor heating applications, large scale coverage needs, and spaces with 7-12 foot mounting heights.
- Typically installed with our custom controls, to vary the electric load for comfortable heat in a wide range of conditions. Fabricated from durable 304 stainless steel for years of exterior use.
- Choose from 3,000-6,000 watt and 208-480 volt capacities.
- May also be installed with Duplex/Stack Switches for effectively a half-power or full-power option.

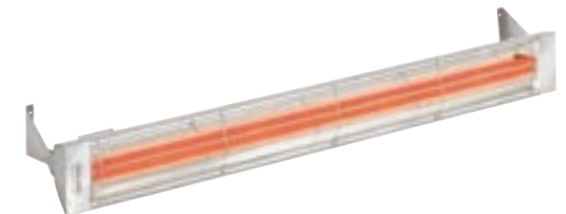

expanding the possibilities of *design versatility*.

MOTIF

COLLECTION

Introducing Motif, the first-ever collection of laser-cut decorative metal covers for Infratech outdoor heating systems.

Our industry-leading range of aesthetic choices has recently expanded with our most designer-friendly offering yet. The Motif collection of stylish, laser-cut decorative fascias can be added to Infratech C-Series and CD-Series heaters, to further customize your comfort. Motif collection fascias are compatible with ceiling, pole and wall-mounting applications, but are not compatible with Infratech flush mount frames.

CONTEMPORARY

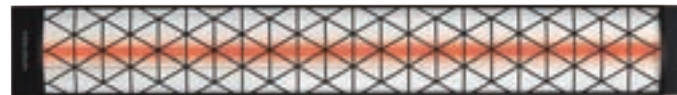

Infratech's Contemporary fascia has been designed to add visual interest to the modern home. It is inspired by the clean lines and iconic forms of the Minimalist, Modern and Mid-Century aesthetic traditions.

CRAFTSMAN

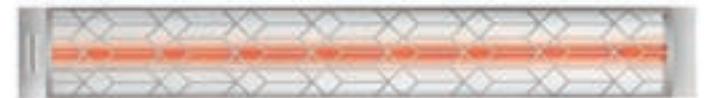
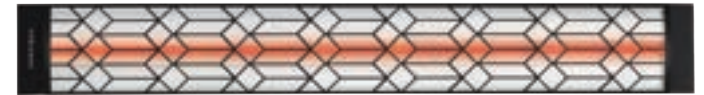

Arts and Crafts and Deco elements combine in our Craftsman-inspired decorative fascia. This design incorporates geometric forms inspired by Frank Lloyd Wright and Greene and Greene, to complement everything from stately homes to cozy bungalows.





MEDITERRANEAN

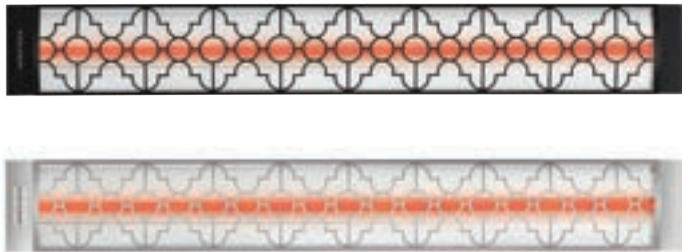

Moorish circular flourishes characterize our Mediterranean-inspired decorative fascia. This design offers an appealing visual accent for Spanish-style, Tuscan, French Country or Southwestern properties.

TRADITIONAL



America's design heritage is reflected in our Traditional decorative fascia. This design is inspired by Colonial, Victorian, Farmhouse and Transitional architecture, and complements properties with traditional shapes and forms.

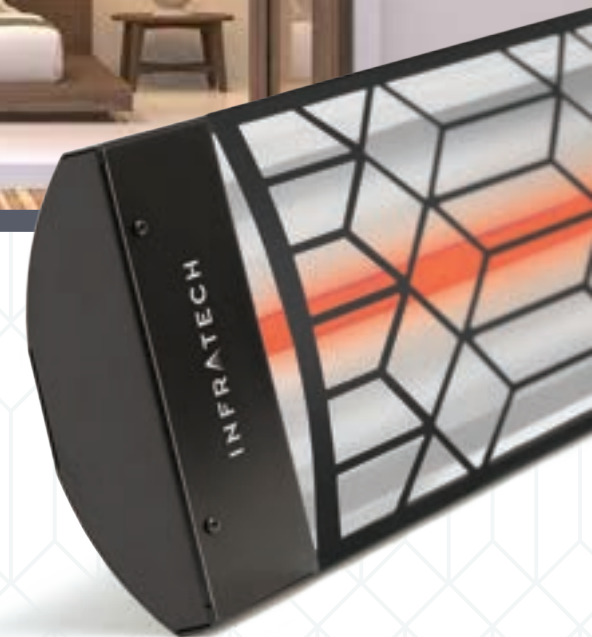

Infratech's fascias are designed to snap seamlessly onto the heater body, providing an easy upgrade for any new or previously installed C-Series or CD-Series heater.



your comfort, *within your control.*

Why choose one of Infratech's three custom controls:

- The convenience of heat intensity and timer functions to maximize energy efficiency and for ease of operation.
- The ability to create multiple heating zones – with one or more heaters in each zone.
- Relay Panels are custom built to be job specific for your project, with wiring diagrams provided.
- Infratech is a UL 508 Listed Control Manufacturer. All of our custom controls are assigned a UL Listed number and are tested to align with our quality standards before leaving our factory.
- All controls and panels are covered by our Three-Year Warranty – the most extensive in the industry.



Solid State Control Packages

- Adjust heating intensity, to achieve the ideal comfort for your space.
- Enjoy Zone Heating – the capability to control one or more heaters to heat specified target areas within a large-scale space with a single touch.
- Uses the Solid State Relay Panel and Zone Analog Controller with Timer. They are designed to work in conjunction with each other and are project specific.
- All Analog Controllers with Timers are also available in white, by special order.



Home Management Systems

- Integrate Infratech's heaters directly into your home management system, so you can get the most automation control out of your living space.
- Control the heat without leaving your seat by using Infratech's Home Management Panel in conjunction with your systems interface.
- Choose from a wide range of programming options available through your home management system, including the ability to save preferred heat settings for off-site control via mobile device.
- Enjoy compatibility with top selling systems such as Lutron,[™] Crestron,[™] Control 4,[™] and others.



Universal Control Packages

- Install and control your Infratech heaters using any 120V lighting dimmer of your choice, to coordinate with your home or commercial property's décor – an Infratech exclusive.
- Use the included 120V Universal Slide Dimmer and Timer, provided for convenience.
- Create multiple heating zones – an ideal feature for larger residential or commercial properties.
- Remotely control your heating system from a smartphone or tablet via a Wi-Fi/Bluetooth[®] compatible device that can be purchased from a third party to achieve this function.

Solid State Control Packages

ZONE ANALOG CONTROLLERS W/ DIGITAL TIMER

For use with the Solid State Relay Panel

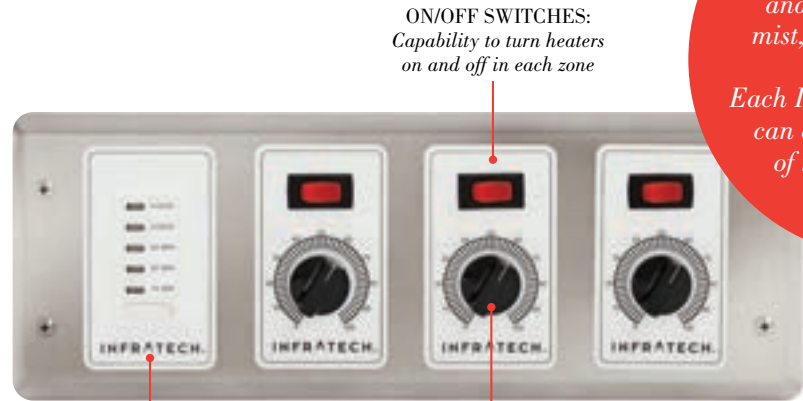

ON/OFF SWITCHES:
Capability to turn heaters
on and off in each zone

DIGITAL TIMER:
Intervals of 15 min,
30 min, 60 min, 2
hours, and 4 hours

INTENSITY CONTROL KNOB:
Offers the ability to control the
intensity of heat of one or more
heaters in a specified target area

*Controllers are
NEMA 12 RATED,
and can be exposed to
mist, but not direct rain.*

*Each Intensity Control Knob
can control a maximum
of three relays in the
Relay Panel.*

*Relay Panels are
NEMA 4 RATED,
and completely
weather resistant.*

*Maximum of
9,000 watts @ 240V or
8,000 watts @ 208V
per relay.*



30-4045 1 Zone Analog Controller w/ Digital Timer



30-4046 2 Zone Analog Controller w/ Digital Timer



30-4047 3 Zone Analog Controller w/ Digital Timer



30-4048 4 Zone Analog Controller w/ Digital Timer



All Zone Analog Controllers with Timers
also available in white (special order)

SOLID STATE RELAY PANEL

For use in conjunction with
Zone Analog Controllers.



30-4051 1 Relay Panel

30-4052 2 Relay Panel

30-4053 3 Relay Panel

30-4054 4 Relay Panel

30-4055 5 Relay Panel

30-4056 6 Relay Panel

Note: NEMA 4 Rated Panel

UNIVERSAL CONTROL RELAY PANEL

A complete solution that will work
with almost any 120V Lighting Control.



30-4071 1 Relay Universal Panel

30-4072 2 Relay Universal Panel

30-4073 3 Relay Universal Panel

30-4074 4 Relay Universal Panel

30-4075 5 Relay Universal Panel

30-4076 6 Relay Universal Panel

Note: NEMA 4 Rated Panel

HOME MANAGEMENT RELAY PANEL

For use in conjunction with your
home management system.
(Requires 0-10V DC Signal)



30-4061 1 Relay Home Management Panel

30-4062 2 Relay Home Management Panel

30-4063 3 Relay Home Management Panel

30-4064 4 Relay Home Management Panel

30-4065 5 Relay Home Management Panel

30-4066 6 Relay Home Management Panel

Note: NEMA 3 Rated Panel

a smarter, hands-free home.



Our products are built to deliver comfort and convenience – which is why they're compatible with the latest trends in home automation technology. Infratech is the only outdoor comfort heat provider that enables smart home integration – whether your space is wired with a comprehensive home management system, or configured for voice-activated, hands-free automation via mobile device or a smart home assistant.

From **smart home** to **voice activation** and everything in between – exclusively with Infratech.

- Infratech's exclusive Universal Control Package can be paired with any CFL- and LED-friendly 120-volt dimmer switches, to enable remote control using a mobile device, or hands-free voice activation via apps compatible with Alexa, Siri or the Google Home Assistant and smart home assistants like the Amazon Echo, Apple HomePod or Google Home Smart Speaker.
- Infratech's Home Management Panel is compatible with top-selling systems such as Lutron™, Crestron™, Control 4™, Savant™, and others. Infratech's simple interface uses a 0-10V DC Signal for streamlined installation and straightforward programming.
- Select from an assortment of decorative switches, wall plates and operator interfaces to control your Infratech heaters through your home management system – or select the switches of your choice, using our Universal Control Panel.

GETTING STARTED IS EASY

- A licensed electrician can guide you to the solution that's best and help you choose the right controls to configure your system.
- Every smart home has its own unique needs. See how others are achieving their goals and view smart home installations at: www.infratech-usa.com/blog.



Value Controls

From Simple On/Off Switches to Duplex Stack Switches to INF Input Regulators, Infratech offers an assortment of Value Controls, to help you enjoy efficient ease of use that's compatible with any budget. All assemblies are available in different configurations, including In-Wall or Surface Mount options, with or without weatherproof covers.

SIMPLE ON/OFF SWITCHES

Designed for use with all single element heaters.

- Low cost control option for all single element heaters.
- Each heater must have its own On/Off Switch.
- Range 120/277 VAC (20 amps max per switch).

IN-WALL FOR INDOOR OR PROTECTED OUTDOOR AREAS



14-4400 Single SS Wall Plate w/ Gang Box
14-4405 Dual SS Wall Plate w/ Gang Box

IN-WALL FOR EXPOSED OUTDOOR AREAS



14-4410 Single Flush Mount w/ Weatherproof Cover
14-4415 Dual Flush Mount w/ Weatherproof Cover

SURFACE MOUNT FOR EXPOSED OUTDOOR AREAS



14-4420 Single Surface Mount w/ Weatherproof Box
14-4425 Dual Surface Mount w/ Weatherproof Box

DUPLEX STACK SWITCHES

Designed for use with all dual element heaters.

- Low cost control option for all dual element heaters.
- Ability to turn on and off each element independently, providing effectively half power/full power capabilities.
- Range 120/277 VAC (20 amps max per switch).

IN-WALL FOR INDOOR OR PROTECTED OUTDOOR AREAS



14-4300 Single SS Wall Plate w/ Gang Box
14-4305 Dual SS Wall Plate w/ Gang Box

IN-WALL FOR EXPOSED OUTDOOR AREAS



14-4310 Single Flush Mount w/ Weatherproof Cover
14-4315 Dual Flush Mount w/ Weatherproof Cover

SURFACE MOUNT FOR EXPOSED OUTDOOR AREAS



14-4320 Single Surface Mount w/ Weatherproof Box
14-4325 Dual Surface Mount w/ Weatherproof Box

INF INPUT REGULATORS

Designed only for use with single element heaters.

- Low cost control option for single element heaters up to 3,000 watts (maximum 15 amps).
- Not a dimmer – INF gently cycles the heater on/off at regular intervals when not on full power.
- Each heater must have its own INF Input Regulator.
- Not for use with Contactor Panels.

IN-WALL FOR INDOOR OR PROTECTED OUTDOOR AREAS



14-4200 Single SS Wall Plate w/ Deep Gang Box
14-4205 Dual SS Wall Plate w/ Deep Gang Box

IN-WALL FOR EXPOSED OUTDOOR AREAS



14-4210 Single Flush Mount w/ Weatherproof Cover
14-4215 Dual Flush Mount w/ Weatherproof Cover

SURFACE MOUNT FOR EXPOSED OUTDOOR AREAS



14-4220 Single Surface Mount w/ Weatherproof Box
14-4225 Dual Surface Mount w/ Weatherproof Box

Value Controls, Enhanced with Digital Timer

The Infratech Contactor Panel adds to Value Control options by integrating timer capabilities.

CONTACTOR PANEL WITH DIGITAL TIMER

Designed for use with all Infratech heaters.

- Compatible with Infratech's Duplex Stack Switch and Simple On/Off Switch.
- Enables integration of timers and other 120 VAC controls, including smart devices.
- Max 6,000 watts at 240V per contactor.
- Compact design allows for indoor surface or flush mount applications.
- Type 1 enclosure – indoor use only.



14-4700 CP-6000-1X Single Contactor Panel w/ Cover - Digital Timer included



14-4710 CP-12000-2X Dual Contactor Panel w/ Cover - Digital Timer included
(shown with optional flush mount access door - order 14-4790, sold separately)



To promote year-round comfort, Minarc flush-mounted Infratech WD-Series heaters in a dining space that invites the outdoors in.

designed to achieve *your vision.*

INFRATECH VISIONARY:

Minarc Design

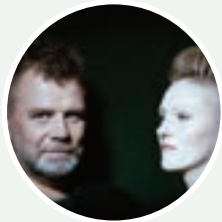

Founded by native Icelanders Erla Dögg and Tryggvi, this award-winning architecture firm's work is distinguished by an outside-in, inside-out ethos grounded in a deep appreciation of nature.

“We are always taking not just the inside out, but also taking the outside in, to even further blur the lines between inside and out.”

Minarc strives to make the most of a site's size, climate and geography while minimizing waste, and eco-conscious practices are holistically incorporated into every project. Whether the team is reusing materials or exploring efficient ways to utilize space, they seek to help clients enjoy all that they have.

ERLA DÖGG AND TRYGGVI,
Architects and Principals
SANTA MONICA, CA



FOR MORE VISIONARIES, PLEASE VISIT INFRATECH-USA.COM/VISIONARIES

Flush mount installation from Infratech

Infratech's flush mount installation option has long been a customer favorite among the interior designers, architects and engineers who develop today's most sought-after commercial and residential properties.

- Flush mounted Infratech W-Series/WD-Series heaters are as stylish as they are versatile, combining the benefits of ambient warmth with a clean, seamless look that vanishes into the décor of a space.
- Heaters can be flush mounted with the edges exposed, or can be partially covered by drywall, plaster, stucco, or a tongue-in-groove wood ceiling treatment.
- Flush mounting is a great choice for rooms with flat ceilings and will not disrupt a space's structural or aesthetic design. Please note, heaters cannot be flush mounted on a ceiling that is sloped or pitched.
- Remember to always use a licensed electrician for installation.

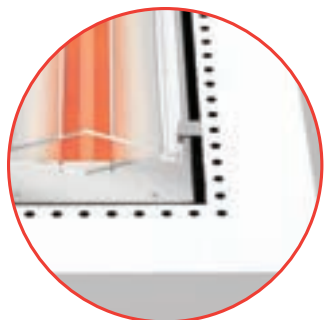

COLORED FRAME OVER FINISHED CEILING



STUCCO OVER FRAME



TONGUE-AND-GROOVE OVER COLORED FRAME



FLUSH MOUNT YOUR HEATER IN FOUR SIMPLE STEPS

STEP 1

Frame the pocket that will house the heater with a one hour-rated fire containment box. Note: Frame and heaters cannot be mounted on a sloped/pitched ceiling.

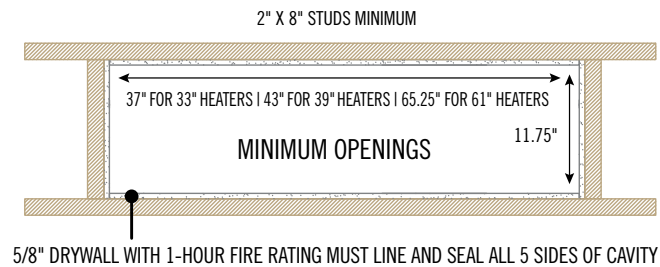

STEP 2

The junction box must be mounted outside of the lined pocket. You can choose to mount the junction box in a variety of locations, depending upon where you'll be accessing it.

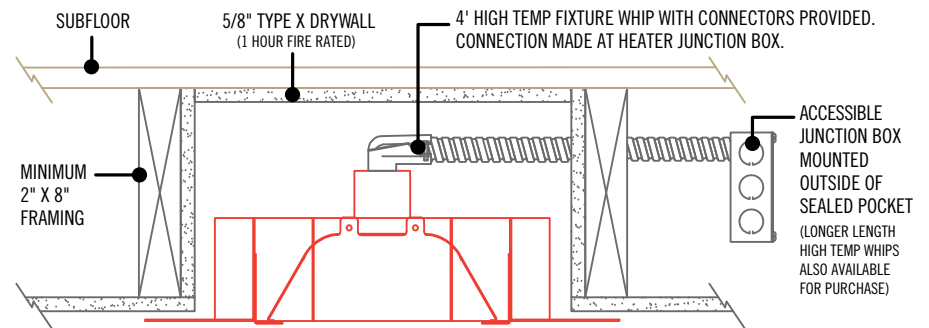

STEP 3

Install the frame into the finished pocket. You may choose to leave all four inches of the trim exposed, or partially cover it with a decorative ceiling (1/2" clearance is required from ventilation holes).

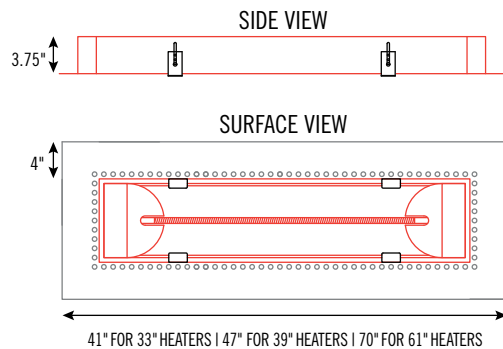

STEP 4

Install the heater (heater must face horizontal to the floor) and adjust the tabs to set the heater flush with finished ceiling.

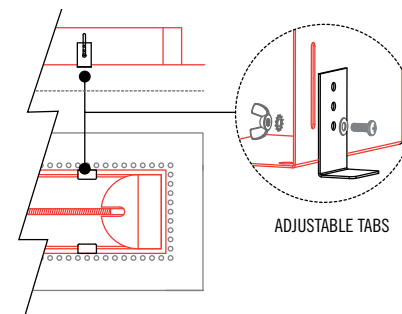

SCAN FOR VIDEO INSTRUCTIONS



WARNING: Frame and heaters cannot be flush mounted on a sloped/pitched ceiling. Flush mount applications must always be installed with heaters horizontal to the floor on a flat, non-sloped ceiling.

colors and finishes *for residential and commercial style.*

Infratech's range of standard and custom color and finish options can complement your distinctive vision for any commercial or residential project.



Color and finish options

- Infratech heaters are available in a brushed stainless steel finish, along with a variety of standard color options that include the samples shown.
- You may also choose your own custom color finish (by special order) that complements your wall or ceiling treatments.
- All Infratech colors are powder coated over 304 stainless steel and baked to achieve a long lasting, fade and corrosion resistant finish.
- Flush mount installations require powder coating the frame, rather than the heater itself, to achieve the desired look.



VIRTUALLY ANY
CUSTOM COLOR
AVAILABLE





INFRATECH VISIONARY:

Park Slope Design



This award-winning firm is led by HGTV-featured landscape designer and exhibiting painter Joan Grabel, who brings her background and sensibility as a fine artist to each project she undertakes.

“Infratech is a high end, beautiful product. It’s streamlined.”

Grabel approaches the landscape with a love of color and form, uniting aesthetic appeal and function with an eco-conscious foundation. She strives to design beautiful, livable and durable outdoor spaces that complement her clients’ lifestyles and exist in harmony with nature.

JOAN GRABEL, *Designer and Principal*
SANTA MONICA, CA AND SANTA FE, NM

FOR MORE VISIONARIES, PLEASE VISIT INFRATECH-USA.COM/VISIONARIES



STANDARD COLORS

C-SERIES | CD-SERIES | W-SERIES | WD-SERIES

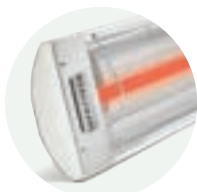

WHITE



BISCUIT



ALMOND



BEIGE

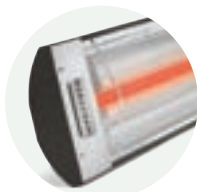

BLACK



BRONZE



GREY



COPPER

SL-SERIES



SILVER



ALL BLACK SLIMLINE SHADOW™

FLUSH MOUNT FRAMES

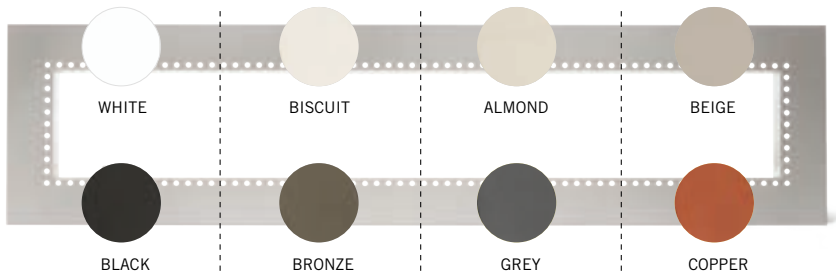

WHITE

BISCUIT

ALMOND

BEIGE

BLACK

BRONZE

GREY

COPPER



welcome
guests in
*comfort
and style.*

Expand opportunities for outdoor seating. Increase table turns. Extend comfort for diners and guests on a year-round basis in milder climates — and improve your commercial property's bottom line. Our team collaborates with award-winning architects, designers and builders during initial planning stages, to develop comprehensive, low-profile heating solutions that add custom-controlled, energy-efficient, ambient warmth that can help drive increased ROI for your property.

Why Infratech is the perfect amenity for your **commercial space**

EXTEND YOUR OUTDOOR FOOTPRINT

- Infratech infrared heaters are ideal for outdoor spaces like rooftop decks, smoking sections or valet waiting areas.
- They transfer heat directly to objects, so warmth will not “blow away” in windy conditions.
- They can be easily mounted to existing structures or incorporated into new construction.
- Infratech heaters can be grouped and regulated in different zones, for the ability to adjust comfort while minimizing energy consumption.
- Infratech control packages can accommodate commercial spaces of all sizes.
- Our technical customer service team can help you determine the best heater, control, color and mounting options for your project.

LASTING ENERGY EFFICIENCY AND VALUE





- Infrared heaters require no refillable tanks and are virtually maintenance free.
- Over 90% energy efficient operation provides energy savings over time.
- Infratech heaters are fabricated from durable 304 stainless steel.
- Infratech’s Three-Year Warranty is the most extensive in the industry.
- Infratech quartz elements are rated for up to 5,000 hours of use.

PROMOTES IMPROVED HEALTH AND SAFETY

- Infratech heaters expand outdoor dining opportunities, to support public health.
- They generate zero emissions or unpleasant odors.



HOW INFRATECH CAN HELP ADD REVENUE TO A COMMERCIAL PROPERTY

-  Generates more nights of use from an outdoor patio or terrace space
EXAMPLE:
20 patio tables (4 people per table) X an additional 60 days/nights a year outside = 4,800 customers a year
75% occupancy = 3,600 customers per year / average \$25 spending per person adds \$90,000 in revenue per year
-  Encourages guests to linger longer in comfort, ordering dessert or drinks
-  Enables businesses to book reservations with confidence, knowing guests will be comfortable in cooler temperatures
-  Improves efficiency, reduces cost for staff who no longer have to move, refill or monitor propane heaters



choosing your *Infratech* system.

STEP
1

Measure the dimensions and mounting heights of the area you want to heat.

STEP
2

Select the heater(s) that will work both functionally and aesthetically for your space. Consider heater size, quantity, color and mounting options.

STEP
3

Choose the control option that works best for your space, needs and budget.

C-15 | SL-16
W-15

HEAT COVERAGE AREA: 5' x 5'
MOUNTING HEIGHT: 6' to 7'

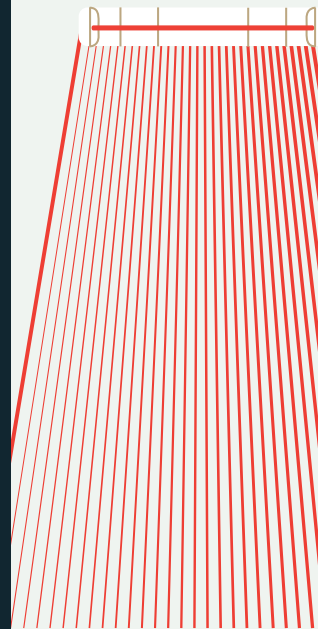

C-15 LENGTH: 33" | 1500 WATTS
SL-16 LENGTH: 29.5" | 1600 WATTS
W-15 LENGTH: 33" | 1500 WATTS

C-20 | W-20

HEAT COVERAGE AREA: 6' x 6'
MOUNTING HEIGHT: 7' to 8'

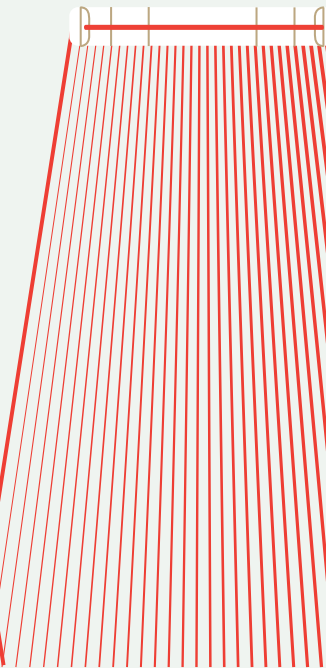

C-20 LENGTH: 39" | 2000 WATTS
W-20 LENGTH: 39" | 2000 WATTS

C-25 | CD-30
SL-24 | W-25 | WD-30

HEAT COVERAGE AREA: 7' x 7'
MOUNTING HEIGHT: 7' to 8'

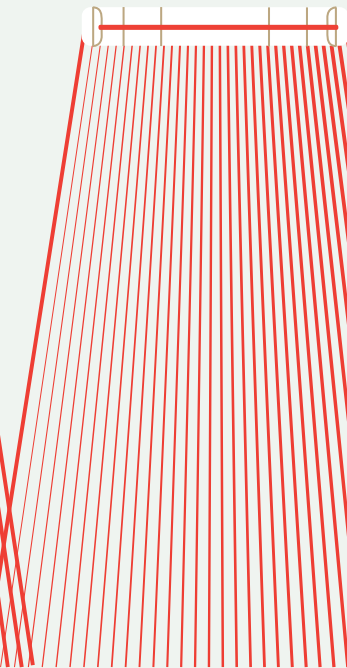

C-25 LENGTH: 39" | 2500 WATTS
CD-30 LENGTH: 33" | 3000 WATTS
SL-24 LENGTH: 42.5" | 2400 WATTS
W-25 LENGTH: 39" | 2500 WATTS
WD-30 LENGTH: 33" | 3000 WATTS

C=C-SERIES SINGLE ELEMENT HEATERS (WIDTH: 8.19")
CD=CD-SERIES DUAL ELEMENT HEATERS (WIDTH: 8.19")

SL=SLIMLINE SINGLE ELEMENT HEATERS (WIDTH: 4.75")

C-30 | SL-30 | W-30

HEAT COVERAGE AREA: 8' x 8'
MOUNTING HEIGHT: 7' to 9'

C-40 | SL-40 | W-40

HEAT COVERAGE AREA: 10' x 10'
MOUNTING HEIGHT: 8' to 10'

CD-40 | WD-40

HEAT COVERAGE AREA: 8' x 10'
MOUNTING HEIGHT: 8' to 10'

CD-50 | WD-50

HEAT COVERAGE AREA: 9' x 10'
MOUNTING HEIGHT: 8' to 10'

CD-60 | WD-60

HEAT COVERAGE AREA: 11' x 11'
MOUNTING HEIGHT: 8' to 12'

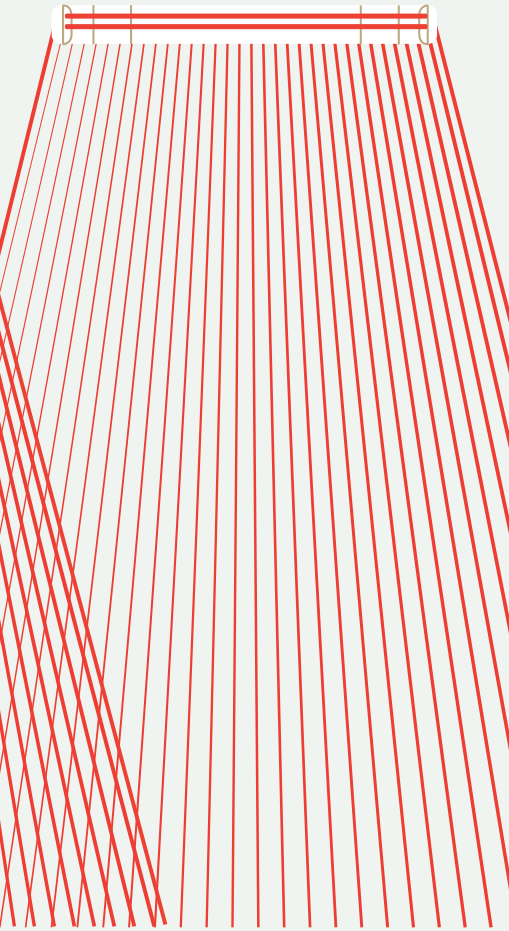
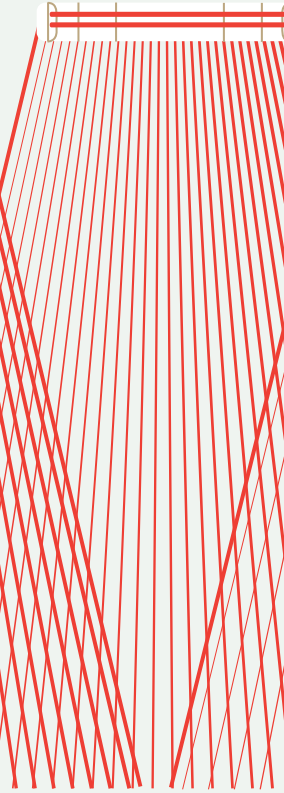
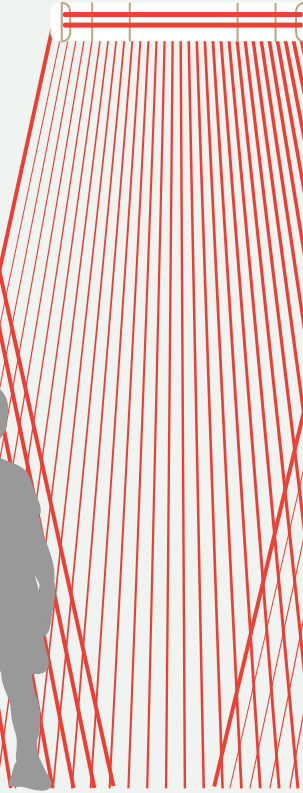
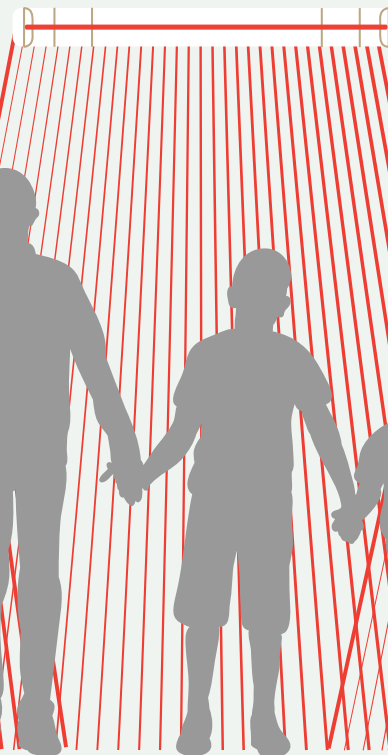

C-30 LENGTH: 61.25" | 3000 WATTS
SL-30 LENGTH: 63.5" | 3000 WATTS
W-30 LENGTH: 61.25" | 3000 WATTS

C-40 LENGTH: 61.25" | 4000 WATTS
SL-40 LENGTH: 63.5" | 4000 WATTS
W-40 LENGTH: 61.25" | 4000 WATTS

CD-40 LENGTH: 39" | 4000 WATTS
WD-40 LENGTH: 39" | 4000 WATTS

CD-50 LENGTH: 39" | 5000 WATTS
WD-50 LENGTH: 39" | 5000 WATTS

CD-60 LENGTH: 61.25" | 6000 WATTS
WD-60 LENGTH: 61.25" | 6000 WATTS

W=W-SERIES SINGLE ELEMENT HEATERS (WIDTH: 8.19")
WD=WD-SERIES DUAL ELEMENT HEATERS (WIDTH: 8.19")

Note: Well-protected environments will generally exceed average coverage.
Heaters may provide less than average coverage in extremely cold or windy conditions.

Parts List and Specifications



PART NUMBER	MODEL	LENGTH	BTU'S	WATTS	VOLTS	AMPS	SHIPPING WEIGHT	CONTROL OPTIONS				MOUNTING OPTIONS				
								ON/OFF SWITCH	DUPLEX/STACK SWITCH (HALF POWER/FULL POWER)	INPUT REGULATOR	CUSTOM CONTROLS	W-33 FLUSH MOUNT FRAME	W-39 FLUSH MOUNT FRAME	W-61 FLUSH MOUNT FRAME	W-39 POLE MOUNT	W-61 POLE MOUNT
C-SERIES (304 STAINLESS STEEL)																
21-3000	C-1512 SS	33"	5,118	1,500	120	12.5	12	•		•		•				
21-3015	C-2024 SS	39"	6,824	2,000	240	8.3	13	•		•	•		•			
21-3100	C-2524 SS	39"	8,530	2,500	240	10.4	13	•		•	•		•			
21-3200	C-3024 SS	61-1/4"	10,236	3,000	240	12.5	20	•		•	•			•	•	
21-3300	C-4024 SS	61-1/4"	13,648	4,000	240	16.7	20	•			•			•	•	
CD-SERIES (304 STAINLESS STEEL)																
21-4000	CD-3024 SS	33"	10,240	3,000	240	12.5	13		•		•					
21-4100	CD-4024 SS	39"	13,648	4,000	240	16.7	14		•		•		•		•	
21-4200	CD-5024 SS	39"	17,060	5,000	240	20.8	14		•		•		•		•	
21-4300	CD-6024 SS	61-1/4"	20,472	6,000	240	25.0	21		•		•			•	•	
SL-SERIES (304 STAINLESS STEEL WITH ANODIZED ALUMINUM HOUSING*)																
21-4990	SL-1612	29.5"	5,461	1,600	120	13.3	10	•		•						
21-4995	SL-1624	29.5"	5,461	1,600	240	6.7	13	•		•	•					
21-5000	SL-2424	42.5"	8,192	2,400	240	10	13	•		•	•					
21-5040	SL-3024	63.5"	10,240	3,000	240	12.5	17	•		•	•					
21-5080	SL-4024	63.5"	13,653	4,000	240	16.7	17	•			•					
*Add "BL" for all black Slimline Shadow™ heater and trim (see page 21).																
W-SERIES (304 STAINLESS STEEL)																
21-1040	W-1512 SS	33"	5,118	1,500	120	12.5	12	•		•		•				
21-1055	W-2024 SS	39"	6,824	2,000	240	8.3	13	•		•	•		•		•	
21-1080	W-2524 SS	39"	8,530	2,500	240	10.4	13	•		•	•		•		•	
21-1100	W-3024 SS	61-1/4"	10,236	3,000	240	12.5	20	•		•	•			•	•	
21-1125	W-4024 SS	61-1/4"	13,648	4,000	240	16.7	20	•			•			•	•	
WD-SERIES (304 STAINLESS STEEL)																
21-2000	WD-3024 SS	33"	10,240	3,000	240	12.5	13		•		•					
21-2100	WD-4024 SS	39"	13,648	4,000	240	16.7	14		•		•		•		•	
21-2200	WD-5024 SS	39"	17,060	5,000	240	20.8	14		•		•		•		•	
21-2300	WD-6024 SS	61-1/4"	20,472	6,000	240	25.0	21		•		•			•	•	

CUSTOM CONTROL OPTIONS

SOLID STATE RELAY PANELS

PART NUMBER	MODEL
30-4051	1 Relay Control Panel
30-4052	2 Relay Control Panel
30-4053	3 Relay Control Panel
30-4054	4 Relay Control Panel
30-4055	5 Relay Control Panel
30-4056	6 Relay Control Panel

ANALOG CONTROLLERS

PART NUMBER	MODEL
30-4045	1 Zone Analog Controller w/ Digital Timer
30-4046	2 Zone Analog Controller w/ Digital Timer
30-4047	3 Zone Analog Controller w/ Digital Timer
30-4048	4 Zone Analog Controller w/ Digital Timer

*Add "WH" to the part number for white Zone Analog Controllers

HOME MANAGEMENT RELAY PANELS

PART NUMBER	MODEL
30-4061	1 Relay Home Management Panel
30-4062	2 Relay Home Management Panel
30-4063	3 Relay Home Management Panel
30-4064	4 Relay Home Management Panel
30-4065	5 Relay Home Management Panel
30-4066	6 Relay Home Management Panel

UNIVERSAL RELAY PANELS

PART NUMBER	MODEL
30-4071	1 Relay Universal Panel
30-4072	2 Relay Universal Panel
30-4073	3 Relay Universal Panel
30-4074	4 Relay Universal Panel
30-4075	5 Relay Universal Panel
30-4076	6 Relay Universal Panel

Relay Panels requiring more than six relays are also available by special order. Please contact us for details.

CONTACTOR RELAY PANELS

PART NUMBER	MODEL
14-4700	CP-6000-1X Single Contactor Panel w/ Timer
14-4710	CP-12000-2X Dual Contactor Panel w/ Timer

VALUE CONTROLS

SIMPLE ON/OFF SWITCHES

PART NUMBER	MODEL
14-4400	Single SS Wall Plate w/ Gang Box
14-4405	Dual SS Wall Plate w/ Gang Box
14-4410	Single Flush Mount w/ Weatherproof Cover
14-4415	Dual Flush Mount w/ Weatherproof Cover
14-4420	Single Surface Mount w/ Weatherproof Box
14-4425	Dual Surface Mount w/ Weatherproof Box

Range 120/277 VAC (20 Amps max per switch)

DUPLEX STACK SWITCHES

PART NUMBER	MODEL
14-4300	Single SS Wall Plate w/ Gang Box
14-4305	Dual SS Wall Plate w/ Gang Box
14-4310	Single Flush Mount w/ Weatherproof Cover
14-4315	Dual Flush Mount w/ Weatherproof Cover
14-4320	Single Surface Mount w/ Weatherproof Box
14-4325	Dual Surface Mount w/ Weatherproof Box

Range 120/277 VAC (20 Amps max per switch)

INF INPUT REGULATORS**

PART NUMBER	MODEL
14-4200	Single SS Wall Plate w/ Gang Box
14-4205	Dual SS Wall Plate w/ Gang Box
14-4210	Single Flush Mount w/ Weatherproof Cover
14-4215	Dual Flush Mount w/ Weatherproof Cover
14-4220	Single Surface Mount w/ Weatherproof Box
14-4225	Dual Surface Mount w/ Weatherproof Box

** Maximum 15 amps. Part numbers listed are 240V. Also available in 120V.

MOUNTING OPTIONS (FOR C, CD, W, WD-SERIES HEATERS)

FLUSH MOUNT FRAMES

PART NUMBER	MODEL	FITS
18-2295	W-33 Flush Mount Frame	33" Heaters
18-2300	W-39 Flush Mount Frame	39" Heaters
18-2305	W-61 Flush Mount Frame	61-1/4" Heaters

POLE MOUNTS

PART NUMBER	MODEL	FITS
22-1250	W-39 Pole Mount	39" Heaters
22-1255	W-61 Pole Mount	61-1/4" Heaters



American craftsmanship meets the best Three-Year Warranty in the industry.

As a pioneer and leader in our field for more than 50 years, we understand the importance of quality. This is why every Infratech product is backed by decades of industry-leading American craftsmanship, and supported with excellent customer service and the most extensive warranty in our industry – the Infratech Three-Year Warranty. All Infratech products are proudly made in the USA.

Need assistance? We can walk you through the process of selecting the Infratech heating system that's right for you. To learn more, or find a distributor near you, please contact us.

www.infratech-usa.com
sales@infratech-usa.com
800.421.9455

HOMEA

PREMIUM

HOMEA

www.homea.mx

Email: ventas@homea.mx

Whatsapp: (442)258.0251

Tel: (442)216.3552

Lada sin Costo: 01(800)701.2121

INFRATECH
COMFORT

344 W 157th Street | Gardena, CA 90248
TEL 800-421-9455 or 310-354-1250 FAX 310-523-3674
WWW.INFRATECH-USA.COM



PROUDLY
MADE IN USA

THREE YEAR
WARRANTY



COMFORT 2021