

Dawn[®]

Kitchen & Bath Products, Inc.

HOMEA
PREMIUM

HOMEA

www.homea.mx

Email: **ventas@homea.mx**

Whatsapp: **(442)258.0251**

Tel: **(442)216.3552**

Lada sin Costo: **01(800)701.2121**

Price Book

2025-26



Headquartered in California, USA

About Dawn

Dawn Kitchen and Bath Products, Inc. is an American company established in San Francisco, California in 2003. Our factory has over 30 years of manufacturing experience in Stainless Steel Products, Solid Brass Faucets, Bathroom Decor, and TSCA Title VI Vanities. Dawn is proud to bring their designs and innovations to Residential, Hospitality and many other market fields.

We are a family owned company, dedicated to serve The United States of America, Canada, Mexico, Central and South America.

Dawn products are designed to create a harmonious combination of pragmatism and elegance. Considering the kitchen and bathroom the soul of a home, Dawn brings function and aesthetics together to make these spaces comfortable and enjoyable. With modern facilities and innovative techniques, Dawn prides itself on its passion and dedication to delivering satisfaction to daily life.

Dawn Products

Dawn kitchen sinks are formed from 16, 18 or 20 gauge 304 type stainless steel reinforced with satin polished finish and sound absorption pads to ensure durability, hygiene and longevity. They are of smooth and contemporary design to compliment any home. Sink accessories, such as cutting boards, bottom grids, colanders and trays, maximize the performance and productivity of the work space.

Dawn faucets and showers are made of solid brass and plated with chrome or brushed nickel to provide reliability and durability. They come in classic and modern styles with various functions to suit and enhance the visual landscape of a home. Constructed with ceramic disc cartridges which are manufactured in Europe, by the same company that provides cartridges for other brand-name companies. The faucets are durable over the long run in a broader variety of water conditions. The showers are equipped with different spray settings and easy-to-clean spray nozzles to create extraordinary showering experience.

Our Shower Drains are of superior workmanship to ensure the highest quality and are available in various styles to suit the décor of your home. Crafted from 6-, 9-, 11-, 14-, or 18-gauge 304-type stainless steel, they are durable and long lasting, and offer light to heavy duty solutions with excellent flow capacity. The satin polished finish guarantees smooth surfaces, safe drainage, and high hygiene. They are highly resistant to temperature variations and easy to install in almost any kind of construction project.

Dawn Shower Niches offer practical convenience by providing an ideal space for shower products. Featuring waterproof functionality, our niches not only save space, but they can also be tiled to match the surrounding shower walls.

Dawn shower and bath accessories come in both stainless steel and solid brass construction with different styles to create customized bathroom spaces with diverse tastes and styles. Designed to prevent wear and tear, they are easy and durable for everyday use and nearly maintenance free.

Our LED Mirrors are with different light settings, dimensions and applications will provide that additional “touch” to your Bathroom project.

Dawn Vanities come in an array of styles to compliment your design preferences. Our vanities are shipped fully assembled with pre-cut plumbing holes. They are constructed of hardwood materials, with selected natural engineered stone and ceramic tops. Dawn vessel sinks are engraved, tempered finished, hand painted, and formed from glass or ceramic. Our vessel sinks compliment the latest trends in both modern and traditional bathrooms while still maintaining their unique attributes.

Dawn products are certified by CUPC to ensure all North American plumbing codes and the U.S. standards for strength and quality are met.

Corporate Manufacture, China





Table of Contents

About Dawn	001	Pinnacles	144
Table of Contents	002	Shenandoah	144
Sinks	004	Theodore Roosevelt	145
Undermounts	005	Wind Cave	145
Flush Mounts	013	Yosemite	146
Bars	045	Zion	146
ADAs	049	R28 Series	147
Top Mounts	053	R37, R38 Series	148
Sink Accessories	059	Slide Bars	149
Stainless Steel Cabinets	057	Shower Components	150
Faucets	074	Shower Shelves	156
Kitchen	075	Shower Drains	159
Bars	093	Amazon River (LAN)	160
Lavatory	095	Brisbane River (LBE)	162
Wall Mounts	110	Congo-Chambeshi River (LCI)	164
Free Standing Showers	113	Colorado River (LCO)	165
Tub Spouts	114	Dawn (LDA)	167
Faucet Accessories	115	Ganges River (LGS)	169
Showers	117	Heilongjiang (LHG)	170
Trims	118	Irtys River (LIH)	172
Valves	122	The Loire River In France (LLE)	173
Showerheads	123	Mamore River In Brazil (LME)	174
Rainheads	126	Mississippi River (LMI)	176
Handshowers	132	Memuru River (LMU)	177
Shower Components	150	Nile River (LNE)	178
Showers Sets	135	The River Niger In Mali (LNR)	179
Thermostatic Rain Shower	135	Parana River In Argentina (LPA)	180
Acadia	136	Rhone River (LRE)	181
Biscayne	136	Rio Orinoco River (LRO)	183
Big Sur	138	Seine River (LSE)	185
Everglades	138	Thames River (LTS)	186
Grand Canyon	139	Volga River (LVA)	187
Hot Springs	139	Views Along The River Nile (LVG)	189
Joshua Tree	140	Wheaton River (LWN)	190
Lake Tahoe	141	Yangtze River (LYE)	192
Mesa Verde	140	Shower Drain Accessories	194
Mount Rainer	143	Shower Drain Channels	195
North Cascades	143		

Table of Contents

▶ Shower Niches	197	▶ Vanity Cabinet Sets (European)	235
Stainless Steel Finished Shower Niches	197	Kathy	235
Raw Surface Shower Niches	199	Quin	236
Shower Niche Accessories	201	Ruby	237
▶ Shower Glass Doors	202	Suri	238
NAG Series	202	▶ Vanity Cabinet Sets (American)	239
NAI Series	203	Bella	239
NA01, NA02 Series	203	Milan	241
NAS Series	204	▶ LED Back Light Mirrors	243
NAU Series	204	▶ Medicine Mirror Cabinets	248
NKI Series	205	▶ LED Mirrors/Medicine Cabinets	249
NKK Series	205	▶ Mirrors	251
NPQ Series	206, 209	▶ Matte Aluminum Framed Mirrors	254
NWJ Series	207, 208	▶ Vanity Sinks	256
NAA Series	208	Crystal Glass	256
▶ Bath Accessories	211	Tempered Glass	257
2803 Series	211	Ceramic	262
2903 Series	213	Concrete	270
9401 Series	216	Accessories	272
9501 Series	215	Cleaning and Care Instructions	273
9601 Series	216	Return Policy	273
9701 Series	217	Warranty Information	274
9801 Series	218	Contact Dawn	274
Triangle & Rectangle Series	219		
Square Series	220		
Button Series	222		
▶ Modular Cabinets	223		
Dina	225		
Gloria	227		
Julie	229		
Ross	231		
Jane/Jenney (Medicine Cabinets)	234		

All Dawn Kitchen & Bath Products are found nationwide through selected Dawn dealers and online partners. For up-to-date information and store location, please contact us at **877-Dawn-USA (877-329-6872)**.

Sinks • Accessories

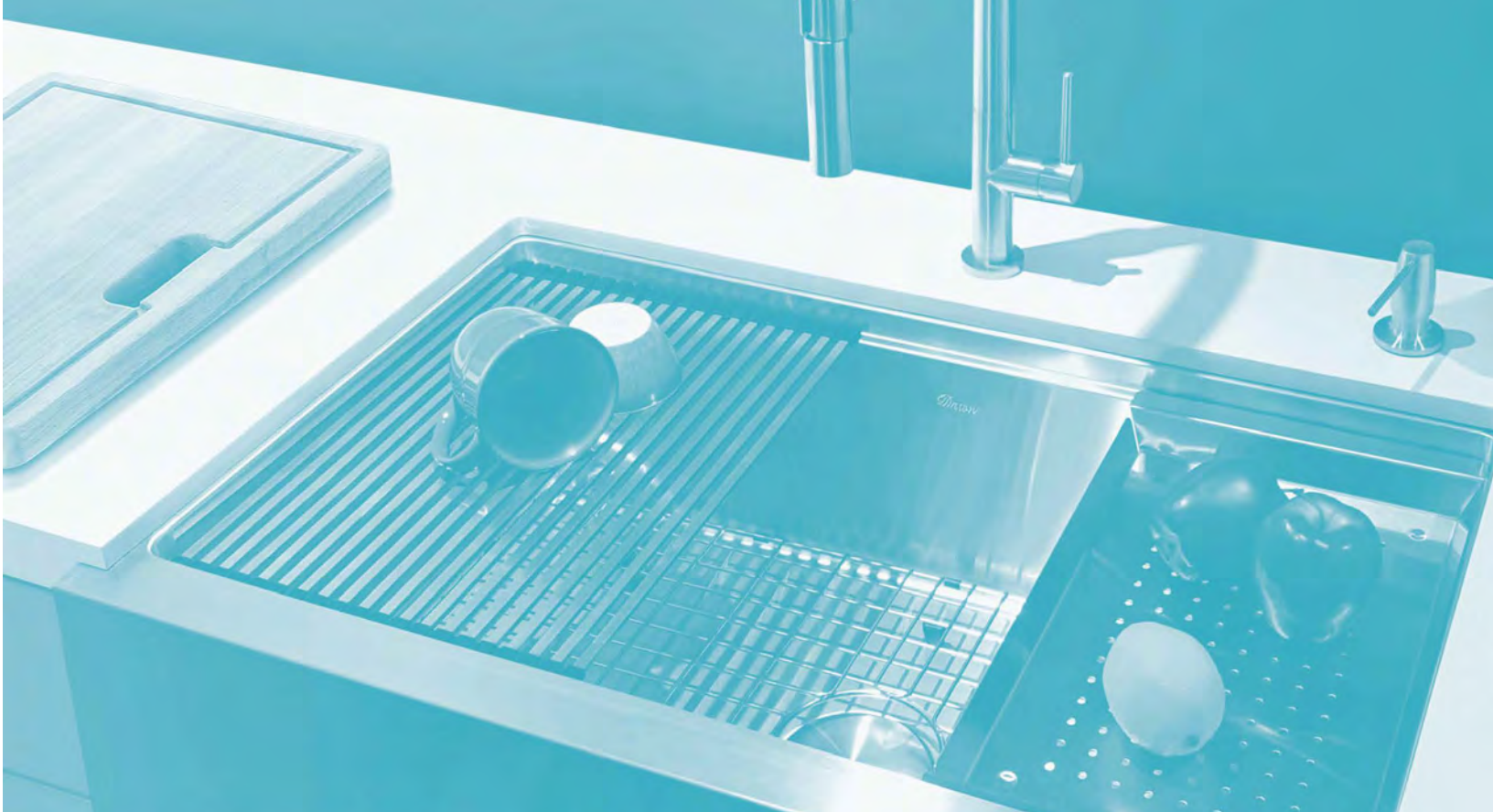

Undermounts 5	Bars 45	ADAs 49	Top Mounts 53
---------------	---------	---------	---------------

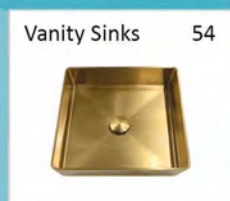

NEW

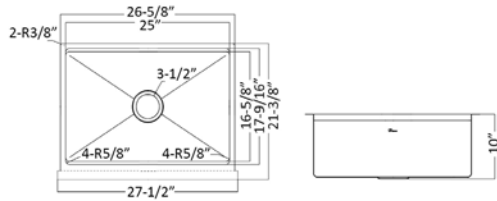

DSRF2520

\$370.00

Small Corner Radius
Straight Apron Single Bowl
Material: 304 Stainless Steel
Content: 18/8 Chrome-Nickel
Gauge: 18
Finish: Polished Satin
Size: 27-1/2" x 21-3/8" x 10"
Drain Opening: 3-1/2"
Undercoating: Padded
Cutout Template included
Limited Lifetime Warranty
Minimum Cabinet Size: 29-1/2"

Optional Accessories:

Bottom Grid **DRG2517**

Size: 24-7/16" x 16-1/8"

List \$57.00

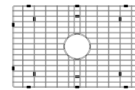

Cutting Board **CB710**

Size: 17-7/16" x 11-13/16" x 1-3/16"

List \$91



Colander **COL710**

Size: 17-7/16" x 10" x 1-1/4"

List \$144



Strainer **SD-01**

Size: 4-5/8" x 3-1/2"

List \$18



Tray **T710**

Size: 12-13/16" x 17-1/2" x 5"

List \$204



Strainer **SD-33**

Size: 4-1/2" x 3-15/16"

List \$23



Drain Mat **DM710**

List \$128

Size: 17-5/16" x 12-3/16" x 5/16"



Strainer **SD-39**

Size: 4-1/2" x 4-3/64"

List \$23



NEW

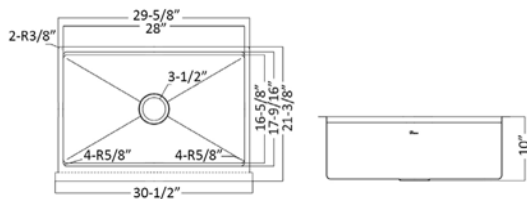

DSRF2820

\$385.00

Small Corner Radius
Straight Apron Single Bowl
Material: 304 Stainless Steel
Content: 18/8 Chrome-Nickel
Gauge: 18
Finish: Polished Satin
Size: 30-1/2" x 21-3/8" x 10"
Drain Opening: 3-1/2"
Undercoating: Padded
Cutout Template included
Limited Lifetime Warranty
Minimum Cabinet Size: 32-1/2"

Optional Accessories:

Bottom Grid **DRG2817**

Size: 27-9/16" x 16-1/8"

List \$62.00

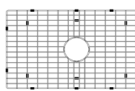

Cutting Board **CB710**

Size: 17-7/16" x 11-13/16" x 1-3/16"

List \$91



Colander **COL710**

Size: 17-7/16" x 10" x 1-1/4"

List \$144



Strainer **SD-01**

Size: 4-5/8" x 3-1/2"

List \$18



Tray **T710**

Size: 12-13/16" x 17-1/2" x 5"

List \$204



Strainer **SD-33**

Size: 4-1/2" x 3-15/16"

List \$23



Drain Mat **DM710**

List \$128

Size: 17-5/16" x 12-3/16" x 5/16"

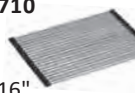

Strainer **SD-39**

Size: 4-1/2" x 4-3/64"

List \$23



The innovation of our designs, reflect the concept of technology in modern living which create the most perfect functional kitchen sinks.



NEW

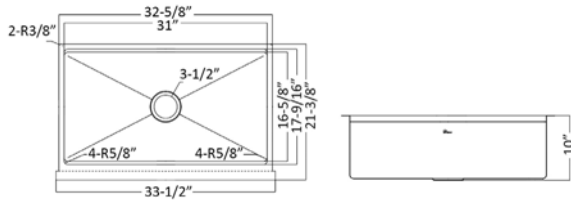

DSRF3120

\$410.00

Small Corner Radius
Straight Apron Single Bowl
Material: 304 Stainless Steel
Content: 18/8 Chrome-Nickel
Gauge: 18
Finish: Polished Satin
Size: 33-1/2" x 21-3/8" x 10"
Drain Opening: 3-1/2"
Undercoating: Padded
Cutout Template included
Limited Lifetime Warranty
Minimum Cabinet Size: 35-1/2"

Optional Accessories:

Bottom Grid **DRG3117**

Size: 30-1/2" x 16-1/8"

List \$66.00

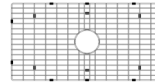

Cutting Board **CB710**

Size: 17-7/16" x 11-13/16" x 1-3/16"

List \$91



Colander **COL710**

Size: 17-7/16" x 10" x 1-1/4"

List \$144



Strainer **SD-01**

Size: 4-5/8" x 3-1/2"

List \$18



Tray **T710**

Size: 12-13/16" x 17-1/2" x 5"

List \$204



Strainer **SD-33**

Size: 4-1/2" x 3-15/16"

List \$23



Drain Mat **DM710**

List \$128

Size: 17-5/16" x 12-3/16" x 5/16"

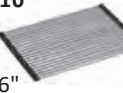

Strainer **SD-39**

Size: 4-1/2" x 4-3/64"

List \$23



NEW

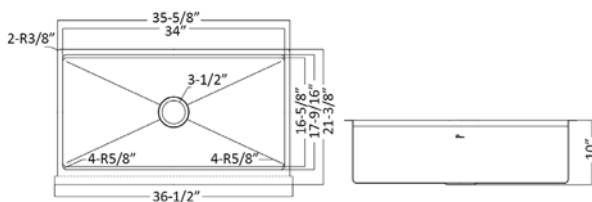

DSRF3420

\$435.00

Small Corner Radius
Straight Apron Single Bowl
Material: 304 Stainless Steel
Content: 18/8 Chrome-Nickel
Gauge: 18
Finish: Polished Satin
Size: 36-1/2" x 21-3/8" x 10"
Drain Opening: 3-1/2"
Undercoating: Padded
Cutout Template included
Limited Lifetime Warranty
Minimum Cabinet Size: 38-1/2"

Optional Accessories:

Bottom Grid **DRG3417**

Size: 33-7/16" x 16-1/8"

List \$70.00

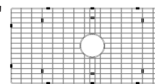

Cutting Board **CB710**

Size: 17-7/16" x 11-13/16" x 1-3/16"

List \$91



Colander **COL710**

Size: 17-7/16" x 10" x 1-1/4"

List \$144



Strainer **SD-01**

Size: 4-5/8" x 3-1/2"

List \$18



Tray **T710**

Size: 12-13/16" x 17-1/2" x 5"

List \$204



Strainer **SD-33**

Size: 4-1/2" x 3-15/16"

List \$23



Drain Mat **DM710**

List \$128

Size: 17-5/16" x 12-3/16" x 5/16"

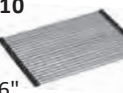

Strainer **SD-39**

Size: 4-1/2" x 4-3/64"

List \$23



Dawn® Stainless Steel Sinks

Primary Line

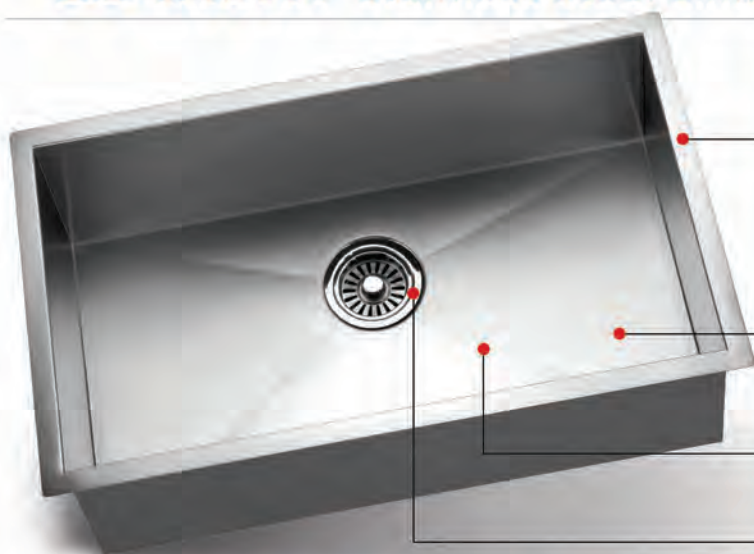

General Features:

- Premium grade of T-304 stainless steel, non-porous, hygienic, rust-free, and durable. 18/10 and 18/8 Chrome-Nickel content to provide luster, durability and strength.
- Elegant satin polished finish, creating an enduring luster resistant to water stains and calcium deposits.
- Gauge sizes vary in different sink models. We carry sinks in 16, 18, and 20 gauge (durable thick steel).
- Rear drain placement creates a more useable sink bottom.
- cUPC certified, ensuring all North American plumbing codes and the U.S. standards for strength and quality have been met.



Butt Welding: the joints on the sink rim are butt welded.



Grinding & Buffing: a grinding machine is used to grind and buff the sink to ensure an even surface and a fine, brushed finish.

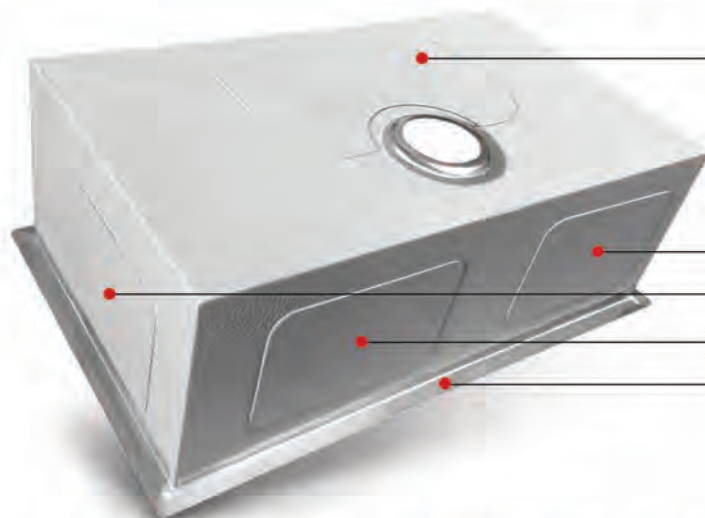

Material Details:

- Sinks are equipped with sound absorption pads underneath the bowl to soften the noise of water dripping into the sink.
- Sound absorption pads to eliminate unwanted sounds (materials: rubber, asphalt, lime, and ecoglué).
- An environment-friendly layer of anti-seepage and anti-condensation coating to prevent water droplets forming when cold food is placed in the sink.



The materials used to manufacture the sound absorption pad are rubber, asphalt, lime, and ecoglué. There is a coat of glue on the bottom side of the pad which adheres to the back of the sink.



When applying the pad to the sink, a roller is used to flatten or even out the pad.

- **Handcrafted Workmanship**
- **Quality Guaranteed**
- **Limited Lifetime Warranty**

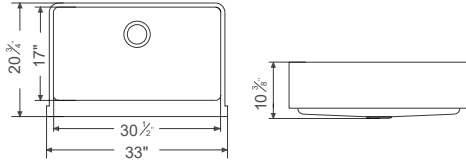

DAF3320

\$980.00

Single Bowl with Straight Apron
Material: 304 Stainless Steel
Content: 18/10 Chrome-Nickel
Gauge: 16
Finish: Polished Satin
Size: 33" x 20-3/4" x 10-3/8"
Drain Opening: 3-1/2"
Undercoating: Padded
Cutout Template included
Limited Lifetime Warranty
Minimum Cabinet Size: 35"

Optional Accessories:

Cutting Board **CB017**

Size: 18-3/8" x 11-3/4" x 1-1/8"

List \$87



Strainer **SD-01**

Size: 4-5/8" x 3-1/2"

List \$18



Strainer **SD-33**

Size: 4-1/2" x 3-15/16"

List \$23



Strainer **SD-39**

Size: 4-1/2" x 4-3/64"

List \$23



Bottom Grid **G031**

Size: 28-5/8" x 15-1/4"

List \$122



Drain Mat **DM001**

Size: 19-11/16" x 12" x 5/16"

List \$176

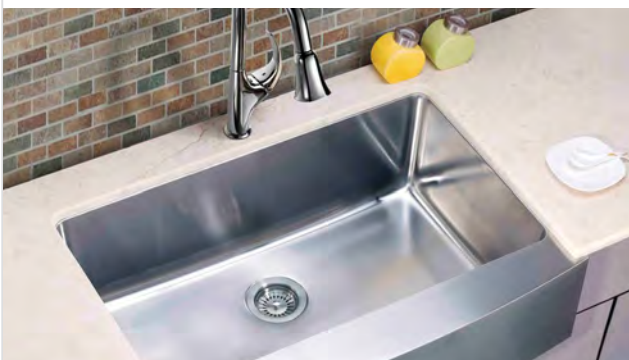
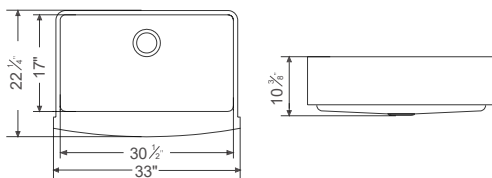
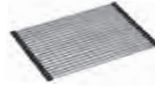

DAF3320C

\$980.00

Single Bowl with Curved Apron
Material: 304 Stainless Steel
Content: 18/10 Chrome-Nickel
Gauge: 16
Finish: Polished Satin
Size: 33" x 22-1/4" x 10-3/8"
Drain Opening: 3-1/2"
Undercoating: Padded
Cutout Template included
Limited Lifetime Warranty
Minimum Cabinet Size: 35"

Optional Accessories:

Cutting Board **CB017**

Size: 18-3/8" x 11-3/4" x 1-1/8"

List \$87



Strainer **SD-01**

Size: 4-5/8" x 3-1/2"

List \$18



Strainer **SD-33**

Size: 4-1/2" x 3-15/16"

List \$23



Strainer **SD-39**

Size: 4-1/2" x 4-3/64"

List \$23



Bottom Grid **G031**

Size: 28-5/8" x 15-1/4"

List \$122



Drain Mat **DM001**

Size: 19-11/16" x 12" x 5/16"

List \$176

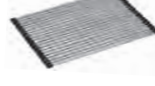

Undermount Apron Front Sinks

Model No. List Price Description

DAF3321L \$950.00

 Double Bowl with Straight Apron
 Material: 304 Stainless Steel
 Content: 18/10 Chrome-Nickel
 Gauge: 18
 Finish: Polished Satin
 Size: 33" x 21" x 10"
 Drain Opening: 3-1/2"
 Undercoating: Padded
 Cutout Template included
 Limited Lifetime Warranty
 Minimum Cabinet Size: 35"

Optional Accessories:
Cutting Board CB017

Size: 18-3/8" x 11-3/4" x 1-1/8"

List \$87

Drain Mat DM018

Size: 16-1/2" x 12-3/16" x 5/16"

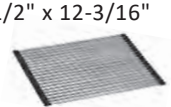
List \$117

Bottom Grid G063

(Small Bowl)

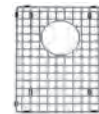
Size: 11-3/8" x 15"

List \$104

Strainer SD-01

Size: 4-5/8" x 3-1/2"

List \$18

Bottom Grid G064

(Large Bowl)

Size: 16-1/2" x 15"

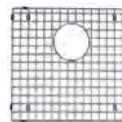
List \$134

Strainer SD-33

Size: 4-1/2" x 3-15/16"

List \$23

Colander COL018

Size: 16-3/4" x 9" x 4-3/4"

List \$186

Strainer SD-39

Size: 4-1/2" x 4-3/64"

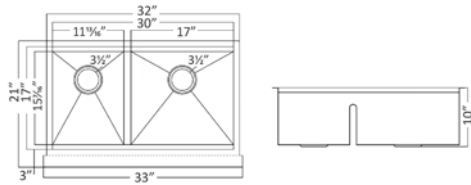
List \$23

NEW

DAF241610 \$620.00

 Small Corner Radius
 Straight Apron Single Bowl
 Material: 304 Stainless Steel
 Content: 18/8 Chrome-Nickel
 Gauge: 18
 Finish: Polished Satin
 Size: 28-5/8" x 21-3/8" x 10"
 Drain Opening: 3-1/2"
 Undercoating: Padded
 Cutout Template included
 Limited Lifetime Warranty
 Minimum Cabinet Size: 30-5/8"

Optional Accessories:
Bottom Grid G713

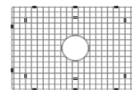
Size: 23-5/8" x 16-3/16"

List \$100.00

Premium Bottom Grid G811

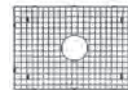
Size: 22-13/16" x 16-1/16"

List \$221.00

Cutting Board CB710

Size: 17-7/16" x 11-13/16" x 1-3/16"

List \$91

Colander COL710

Size: 17-7/16" x 10" x 1-1/4"

List \$144

Strainer SD-01

Size: 4-5/8" x 3-1/2"

List \$18

Tray T710

Size: 12-13/16" x 17-1/2" x 5"

List \$204

Strainer SD-33

Size: 4-1/2" x 3-15/16"

List \$23

Drain Mat DM710

Size: 17-5/16" x 12-3/16" x 5/16"

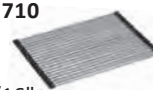
List \$128

Strainer SD-39

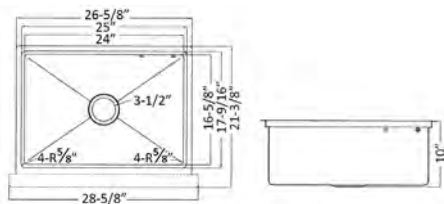
Size: 4-1/2" x 4-3/64"

List \$23

Included Accessory:
Basket BK710

Size: 7-13/16" x 4" x 3-1/8"

List \$34



Undermount Apron Front Sinks

Model No.

List Price

Description

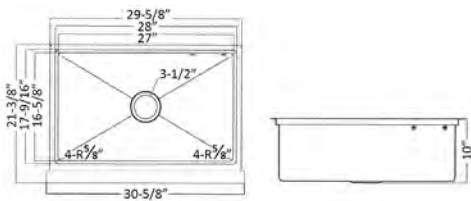
NEW



Included Accessory:

Basket BK710
Size: 7-13/16" x 4" x 3-1/8"
List \$34



DAF281610

\$645.00

Small Corner Radius
Straight Apron Single Bowl
Material: 304 Stainless Steel
Content: 18/8 Chrome-Nickel
Gauge: 18
Finish: Polished Satin
Size: 30-5/8" x 21-3/8" x 10"
Drain Opening: 3-1/2"
Undercoating: Padded
Cutout Template included
Limited Lifetime Warranty
Minimum Cabinet Size: 32-5/8"

Optional Accessories:

Premium Bottom Grid G810

Size: 26-9/16" x 16-1/16"

List \$249.00

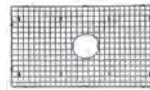

Cutting Board CB710

Size: 17-7/16" x 11-13/16" x 1-3/16"

List \$91



Colander COL710

Size: 17-7/16" x 10" x 1-1/4"

List \$144



Strainer SD-01

Size: 4-5/8" x 3-1/2"

List \$18



Tray T710

Size: 12-13/16" x 17-1/2" x 5"

List \$204



Strainer SD-33

Size: 4-1/2" x 3-15/16"

List \$23



Drain Mat DM710

List \$128

Size: 17-5/16" x 12-3/16" x 5/16"

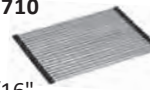

Strainer SD-39

Size: 4-1/2" x 4-3/64"

List \$23



NEW

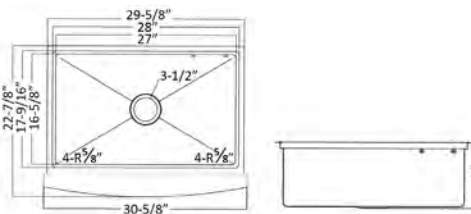

Included Accessory:

Basket BK710
Size: 7-13/16" x 4" x 3-1/8"
List \$34



DAF281610C

\$695.00

Small Corner Radius
Curved Apron Single Bowl
Material: 304 Stainless Steel
Content: 18/8 Chrome-Nickel
Gauge: 18
Finish: Polished Satin
Size: 30-5/8" x 22-7/8" x 10"
Drain Opening: 3-1/2"
Undercoating: Padded
Cutout Template included
Limited Lifetime Warranty
Minimum Cabinet Size: 32-5/8"

Optional Accessories:

Premium Bottom Grid G810

Size: 26-9/16" x 16-1/16"

List \$249.00

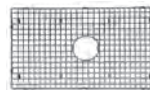

Cutting Board CB710

Size: 17-7/16" x 11-13/16" x 1-3/16"

List \$91



Colander COL710

Size: 17-7/16" x 10" x 1-1/4"

List \$144



Strainer SD-01

Size: 4-5/8" x 3-1/2"

List \$18



Tray T710

Size: 12-13/16" x 17-1/2" x 5"

List \$204



Strainer SD-33

Size: 4-1/2" x 3-15/16"

List \$23



Drain Mat DM710

List \$128

Size: 17-5/16" x 12-3/16" x 5/16"

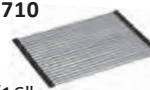

Strainer SD-39

Size: 4-1/2" x 4-3/64"

List \$23



Undermount Apron Front Sinks

Model No. List Price Description

NEW

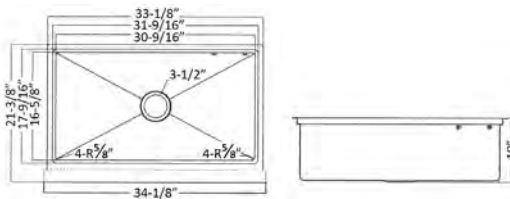

Included Accessory:

Basket BK710
Size: 7-13/16" x 4" x 3-1/8"
List \$34



DAF311710 \$700.00

Small Corner Radius
Straight Apron Single Bowl
Material: 304 Stainless Steel
Content: 18/8 Chrome-Nickel
Gauge: 18
Finish: Polished Satin
Size: 34-1/8" x 21-3/8" x 10"
Drain Opening: 3-1/2"
Undercoating: Padded
Cutout Template included
Limited Lifetime Warranty
Minimum Cabinet Size: 36-1/8"

Optional Accessories:

Premium Bottom Grid G710
Size: 30-1/8" x 16-1/16"
List \$306

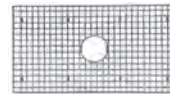

Cutting Board CB710
Size: 17-7/16" x 11-13/16" x 1-3/16"
List \$91



Colander COL710
Size: 17-7/16" x 10" x 1-1/4"
List \$144



Strainer SD-01
Size: 4-5/8" x 3-1/2"
List \$18



Tray T710
Size: 12-13/16" x 17-1/2" x 5"
List \$204



Strainer SD-33
Size: 4-1/2" x 3-15/16"
List \$23



Drain Mat DM710
Size: 17-5/16" x 12-3/16" x 5/16"

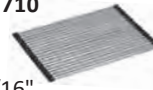

Strainer SD-39
Size: 4-1/2" x 4-3/64"
List \$23



NEW

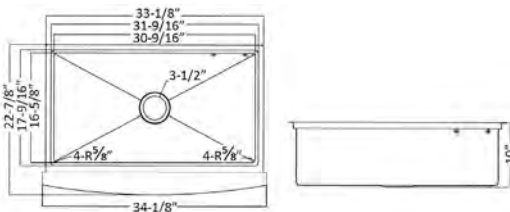

Included Accessory:

Basket BK710
Size: 7-13/16" x 4" x 3-1/8"
List \$34



DAF311710C \$750.00

Small Corner Radius
Curved Apron Single Bowl
Material: 304 Stainless Steel
Content: 18/8 Chrome-Nickel
Gauge: 18
Finish: Polished Satin
Size: 34-1/8" x 22-7/8" x 10"
Drain Opening: 3-1/2"
Undercoating: Padded
Cutout Template included
Limited Lifetime Warranty
Minimum Cabinet Size: 36-1/8"

Optional Accessories:

Premium Bottom Grid G710
Size: 30-1/8" x 16-1/16"
List \$306

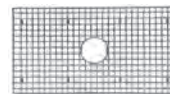

Cutting Board CB710
Size: 17-7/16" x 11-13/16" x 1-3/16"
List \$91



Colander COL710
Size: 17-7/16" x 10" x 1-1/4"
List \$144



Strainer SD-01
Size: 4-5/8" x 3-1/2"
List \$18



Tray T710
Size: 12-13/16" x 17-1/2" x 5"
List \$204



Strainer SD-33
Size: 4-1/2" x 3-15/16"
List \$23



Drain Mat DM710
Size: 17-5/16" x 12-3/16" x 5/16"

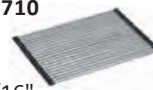

Strainer SD-39
Size: 4-1/2" x 4-3/64"
List \$23



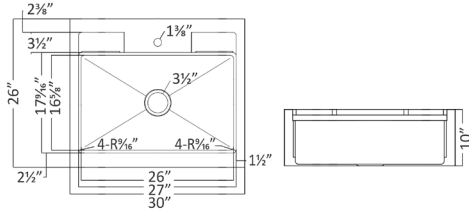

DAFF3026

\$1,150.00

Single Bowl with Straight Apron
Material: 304 Stainless Steel
Content: 18/8 Chrome-Nickel
Gauge: 18
Finish: Polished Satin
Size: 30" x 26" x 10"
Drain Opening: 3-1/2"
Undercoating: Padded
Cutout Template not included
Limited Lifetime Warranty
Minimum Cabinet Size: 32"

Optional Accessories:

Utensil Shelf **T3026**

Size: 6-7/8" x 3" x 1-5/8"

List \$66



Colander **COL710** List \$144

Size: 17-7/16" x 10" x 1-1/4"



Basket **BK3626**

Size: 7" x 7" x 3-1/8"

List \$66



Tray **T710** List \$204

Size: 12-13/16" x 17-1/2" x 5"



Cutting Board **CB710**

Size: 17-7/16" x 11-13/16" x 1-3/16"

List \$91



Strainer **SD-01**

Size: 4-5/8" x 3-1/2"

List \$18



Drain Mat **DM710**

List \$128

Size: 17-5/16" x 12-3/16" x 5/16"

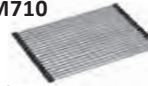

Strainer **SD-33**

Size: 4-1/2" x 3-15/16"

List \$23



Strainer **SD-39**

Size: 4-1/2" x 4-3/64"

List \$23

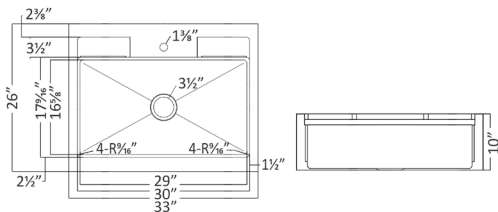

DAFF3326

\$1,200.00

Single Bowl with Straight Apron
Material: 304 Stainless Steel
Content: 18/8 Chrome-Nickel
Gauge: 18
Finish: Polished Satin
Size: 33" x 26" x 10"
Drain Opening: 3-1/2"
Undercoating: Padded
Cutout Template not included
Limited Lifetime Warranty
Minimum Cabinet Size: 35"

Optional Accessories:

Utensil Shelf **T3326**

Size: 8-1/4" x 3" x 1-5/8"

List \$72



Colander **COL710** List \$144

Size: 17-7/16" x 10" x 1-1/4"



Basket **BK3626**

Size: 7" x 7" x 3-1/8"

List \$66



Tray **T710** List \$204

Size: 12-13/16" x 17-1/2" x 5"



Cutting Board **CB710**

Size: 17-7/16" x 11-13/16" x 1-3/16"

List \$91



Strainer **SD-01**

Size: 4-5/8" x 3-1/2"

List \$18



Drain Mat **DM710**

List \$128

Size: 17-5/16" x 12-3/16" x 5/16"

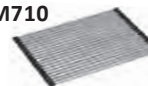

Strainer **SD-33**

Size: 4-1/2" x 3-15/16"

List \$23



Strainer **SD-39**

Size: 4-1/2" x 4-3/64"

List \$23



Flush Mount Apron Front Sinks Model No. List Price Description

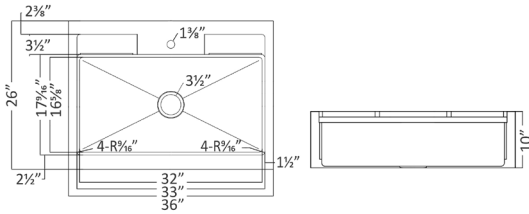

DAFF3626 \$1,250.00 Single Bowl with Straight Apron
 Material: 304 Stainless Steel
 Content: 18/8 Chrome-Nickel
 Gauge: 18
 Finish: Polished Satin
 Size: 36" x 26" x 10"
 Drain Opening: 3-1/2"
 Undercoating: Padded
 Cutout Template not included
 Limited Lifetime Warranty
 Minimum Cabinet Size: 38"

Optional Accessories:

Utensil Shelf T3626
 Size: 10" x 3" x 1-5/8"
List \$78



Basket BK3626
 Size: 7" x 7" x 3-1/8"
List \$66



Cutting Board CB710
 Size: 17-7/16" x 11-13/16"
 x 1-3/16"
List \$91



Drain Mat DM710
List \$128
 Size: 17-5/16"
 x 12-3/16" x 5/16"

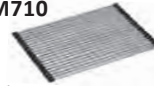

Colander COL710 List \$144
 Size: 17-7/16"
 x 10" x 1-1/4"



Tray T710 List \$204
 Size: 12-13/16"
 x 17-1/2" x 5"



Strainer SD-01
 Size: 4-5/8" x 3-1/2"
List \$18



Strainer SD-33
 Size: 4-1/2" x 3-15/16"
List \$23



Strainer SD-39
 Size: 4-1/2" x 4-3/64"
List \$23



Sinks



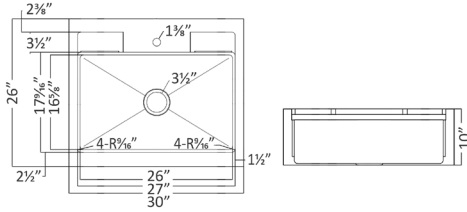

DAFF3026G **\$1,200.00**
(with Black Glass Panel Decorated)

Single Bowl with Straight Apron
 Material: 304 Stainless Steel
 Content: 18/8 Chrome-Nickel
 Gauge: 18
 Finish: Polished Satin
 Size: 30" x 26" x 10"
 Drain Opening: 3-1/2"
 Undercoating: Padded
 Cutout Template not included
 Limited Lifetime Warranty
 Minimum Cabinet Size: 32"

Optional Accessories:

Utensil Shelf **T3026**
 Size: 6-7/8" x 3" x 1-5/8"
List \$66



Basket **BK3626**
 Size: 7" x 7" x 3-1/8"
List \$66



Cutting Board **CB710**
 Size: 17-7/16" x 11-13/16"
 x 1-3/16"
List \$91



Drain Mat **DM710**
List \$128
 Size: 17-5/16"
 x 12-3/16" x 5/16"

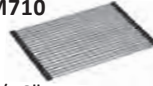

Colander **COL710** **List \$144**
 Size: 17-7/16"
 x 10" x 1-1/4"



Tray **T710** **List \$204**
 Size: 12-13/16"
 x 17-1/2" x 5"



Strainer **SD-01**
 Size: 4-5/8" x 3-1/2"
List \$18



Strainer **SD-33**
 Size: 4-1/2" x 3-15/16"
List \$23



Strainer **SD-39**
 Size: 4-1/2" x 4-3/64"
List \$23

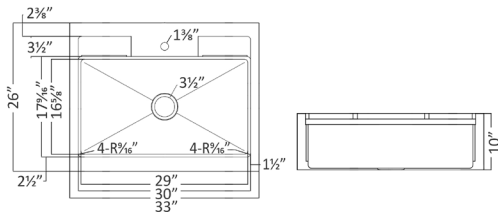

DAFF3326G **\$1,250.00**
(with Black Glass Panel Decorated)

Single Bowl with Straight Apron
 Material: 304 Stainless Steel
 Content: 18/8 Chrome-Nickel
 Gauge: 18
 Finish: Polished Satin
 Size: 33" x 26" x 10"
 Drain Opening: 3-1/2"
 Undercoating: Padded
 Cutout Template not included
 Limited Lifetime Warranty
 Minimum Cabinet Size: 35"

Optional Accessories:

Utensil Shelf **T3326**
 Size: 8-1/4" x 3" x 1-5/8"
List \$72



Basket **BK3626**
 Size: 7" x 7" x 3-1/8"
List \$66



Cutting Board **CB710**
 Size: 17-7/16" x 11-13/16"
 x 1-3/16"
List \$91



Drain Mat **DM710**
List \$128
 Size: 17-5/16"
 x 12-3/16" x 5/16"

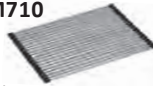

Colander **COL710** **List \$144**
 Size: 17-7/16"
 x 10" x 1-1/4"



Tray **T710** **List \$204**
 Size: 12-13/16"
 x 17-1/2" x 5"



Strainer **SD-01**
 Size: 4-5/8" x 3-1/2"
List \$18



Strainer **SD-33**
 Size: 4-1/2" x 3-15/16"
List \$23



Strainer **SD-39**
 Size: 4-1/2" x 4-3/64"
List \$23



Flush Mount Apron Front Sinks Model No. List Price Description

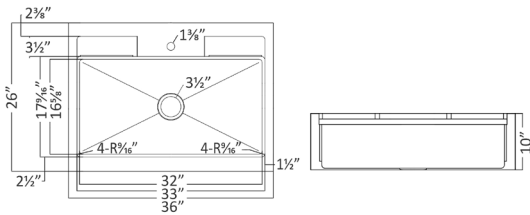

DAFF3626G **\$1,300.00**
 (with Black Glass
 Panel Decorated)

Single Bowl with Straight Apron
 Material: 304 Stainless Steel
 Content: 18/8 Chrome-Nickel
 Gauge: 18
 Finish: Polished Satin
 Size: 36" x 26" x 10"
 Drain Opening: 3-1/2"
 Undercoating: Padded
 Cutout Template not included
 Limited Lifetime Warranty
 Minimum Cabinet Size: 38"

Optional Accessories:

Utensil Shelf **T3626**
 Size: 10" x 3" x 1-5/8"
List \$78



Colander **COL710** **List \$144**
 Size: 17-7/16" x 10" x 1-1/4"



Basket **BK3626**
 Size: 7" x 7" x 3-1/8"
List \$66



Tray **T710** **List \$204**
 Size: 12-13/16" x 17-1/2" x 5"



Cutting Board **CB710**
 Size: 17-7/16" x 11-13/16" x 1-3/16"
List \$91



Strainer **SD-01**
 Size: 4-5/8" x 3-1/2"
List \$18



Drain Mat **DM710**
List \$128
 Size: 17-5/16" x 12-3/16" x 5/16"

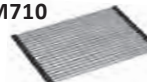

Strainer **SD-33**
 Size: 4-1/2" x 3-15/16"
List \$23



Strainer **SD-39**
 Size: 4-1/2" x 4-3/64"
List \$23



Sinks



Undermount Small Radius Sinks

Model No.

List Price

Description

NEW

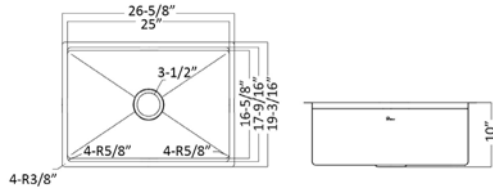

DSR2517

\$295.00

Small Corner Radius Single Bowl
Material: 304 Stainless Steel
Content: 18/10 Chrome-Nickel
Gauge: 18
Finish: Polished Satin
Size: 26-5/8" x 19-3/16" x 10"
Drain Opening: 3-1/2"
Undercoating: Padded
Cutout Template included
Limited Lifetime Warranty
Minimum Cabinet Size: 28-5/8"

Optional Accessories:

Bottom Grid **DRG2517**

Size: 24-7/16" x 16-1/8"

List \$57.00

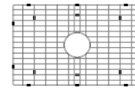

Cutting Board **CB710**

Size: 17-7/16" x 11-13/16" x 1-3/16"

List \$91



Colander **COL710**

Size: 17-7/16" x 10" x 1-1/4"

List \$144



Strainer **SD-01**

Size: 4-5/8" x 3-1/2"

List \$18



Tray **T710**

Size: 12-13/16" x 17-1/2" x 5"

List \$204



Strainer **SD-33**

Size: 4-1/2" x 3-15/16"

List \$23

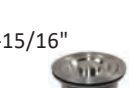

Drain Mat **DM710**

List \$128

Size: 17-5/16" x 12-3/16" x 5/16"

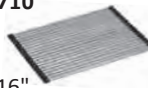

Strainer **SD-39**

Size: 4-1/2" x 4-3/64"

List \$23



NEW

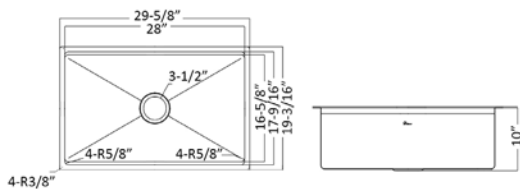

DSR2817

\$310.00

Small Corner Radius Single Bowl
Material: 304 Stainless Steel
Content: 18/10 Chrome-Nickel
Gauge: 18
Finish: Polished Satin
Size: 29-5/8" x 19-3/16" x 10"
Drain Opening: 3-1/2"
Undercoating: Padded
Cutout Template included
Limited Lifetime Warranty
Minimum Cabinet Size: 31-5/8"

Optional Accessories:

Bottom Grid **DRG2817**

Size: 27-9/16" x 16-1/8"

List \$62.00

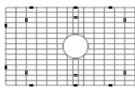

Cutting Board **CB710**

Size: 17-7/16" x 11-13/16" x 1-3/16"

List \$91



Colander **COL710**

Size: 17-7/16" x 10" x 1-1/4"

List \$144



Strainer **SD-01**

Size: 4-5/8" x 3-1/2"

List \$18



Tray **T710**

Size: 12-13/16" x 17-1/2" x 5"

List \$204



Strainer **SD-33**

Size: 4-1/2" x 3-15/16"

List \$23

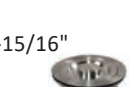

Drain Mat **DM710**

List \$128

Size: 17-5/16" x 12-3/16" x 5/16"

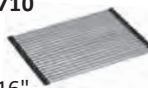

Strainer **SD-39**

Size: 4-1/2" x 4-3/64"

List \$23







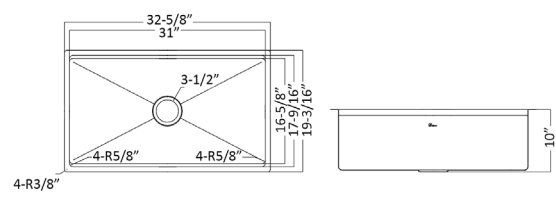

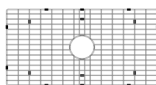

Undermount Small Radius Sinks **Model No.** **List Price** **Description**

NEW

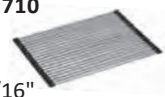

DSR3117 **\$320.00** Small Corner Radius Single Bowl
 Material: 304 Stainless Steel
 Content: 18/10 Chrome-Nickel
 Gauge: 18
 Finish: Polished Satin
 Size: 32-5/8" x 19-3/16" x 10"
 Drain Opening: 3-1/2"
 Undercoating: Padded
 Cutout Template included
 Limited Lifetime Warranty
 Minimum Cabinet Size: 34-5/8"

Optional Accessories:





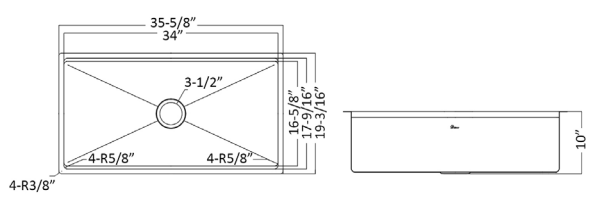

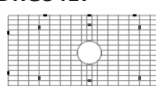

- Bottom Grid **DRG3117** Cutting Board **CB710**
 Size: 30-1/2" x 16-1/8" Size: 17-7/16" x 11-13/16" x 1-3/16"
List \$66.00  **List \$91** 
- Colander **COL710** Strainer **SD-01**
 Size: 17-7/16" x 10" x 1-1/4" Size: 4-5/8" x 3-1/2"
List \$144  **List \$18** 
- Tray **T710** Strainer **SD-33**
 Size: 12-13/16" x 17-1/2" x 5" Size: 4-1/2" x 3-15/16"
List \$204  **List \$23** 
- Drain Mat **DM710** Strainer **SD-39**
 Size: 17-5/16" x 12-3/16" x 5/16" Size: 4-1/2" x 4-3/64"
List \$128  **List \$23** 

NEW

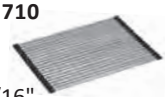

DSR3417 **\$340.00** Small Corner Radius Single Bowl
 Material: 304 Stainless Steel
 Content: 18/10 Chrome-Nickel
 Gauge: 18
 Finish: Polished Satin
 Size: 35-5/8" x 19-3/16" x 10"
 Drain Opening: 3-1/2"
 Undercoating: Padded
 Cutout Template included
 Limited Lifetime Warranty
 Minimum Cabinet Size: 37-5/8"

Optional Accessories:

- Bottom Grid **DRG3417** Cutting Board **CB710**
 Size: 33-7/16" x 16-1/8" Size: 17-7/16" x 11-13/16" x 1-3/16"
List \$70.00  **List \$91** 
- Colander **COL710** Strainer **SD-01**
 Size: 17-7/16" x 10" x 1-1/4" Size: 4-5/8" x 3-1/2"
List \$144  **List \$18** 
- Tray **T710** Strainer **SD-33**
 Size: 12-13/16" x 17-1/2" x 5" Size: 4-1/2" x 3-15/16"
List \$204  **List \$23** 
- Drain Mat **DM710** Strainer **SD-39**
 Size: 17-5/16" x 12-3/16" x 5/16" Size: 4-1/2" x 4-3/64"
List \$128  **List \$23** 

Undermount Small Radius Sinks

Model No. List Price Description

NEW

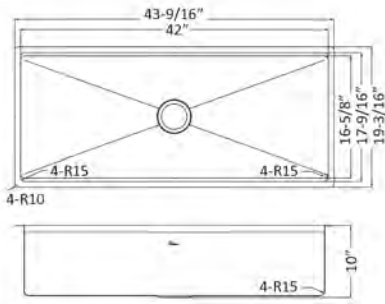

DSR4217 \$500.00 Small Corner Radius Single Bowl
 Material: 304 Stainless Steel
 Content: 18/8 Chrome-Nickel
 Gauge: 18
 Finish: Polished Satin
 Size: 43-9/16" x 19-3/16" x 10"
 Drain Opening: 3-1/2"
 Undercoating: Padded
 Cutout Template included
 Limited Lifetime Warranty
 Minimum Cabinet Size: 45-9/16"

Optional Accessories:

Colander COL710
 Size: 17-7/16" x 10" x 1-1/4"
List \$144



Cutting Board CB710
 Size: 17-7/16" x 11-13/16" x 1-3/16"
List \$91



Tray T710
 Size: 12-13/16" x 17-1/2" x 5"
List \$204



Strainer SD-01
 Size: 4-5/8" x 3-1/2"
List \$18



Drain Mat DM710
 Size: 17-5/16" x 12-3/16" x 5/16"
List \$128

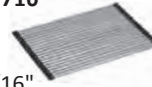

Strainer SD-33
 Size: 4-1/2" x 3-15/16"
List \$23



Strainer SD-39
 Size: 4-1/2" x 4-3/64"
List \$23



NEW

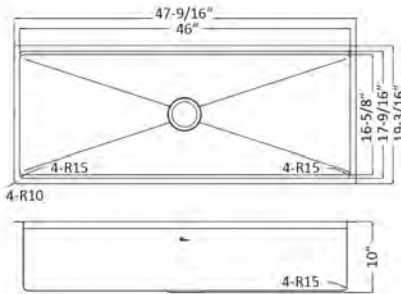

DSR4817 \$550.00 Small Corner Radius Single Bowl
 Material: 304 Stainless Steel
 Content: 18/8 Chrome-Nickel
 Gauge: 18
 Finish: Polished Satin
 Size: 47-9/16" x 19-3/16" x 10"
 Drain Opening: 3-1/2"
 Undercoating: Padded
 Cutout Template included
 Limited Lifetime Warranty
 Minimum Cabinet Size: 49-9/16"

Optional Accessories:

Colander COL710
 Size: 17-7/16" x 10" x 1-1/4"
List \$144



Cutting Board CB710
 Size: 17-7/16" x 11-13/16" x 1-3/16"
List \$91



Tray T710
 Size: 12-13/16" x 17-1/2" x 5"
List \$204



Strainer SD-01
 Size: 4-5/8" x 3-1/2"
List \$18



Drain Mat DM710
 Size: 17-5/16" x 12-3/16" x 5/16"
List \$128

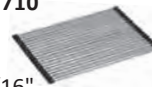

Strainer SD-33
 Size: 4-1/2" x 3-15/16"
List \$23



Strainer SD-39
 Size: 4-1/2" x 4-3/64"
List \$23



Undermount Small Radius Sinks

Model No. List Price Description

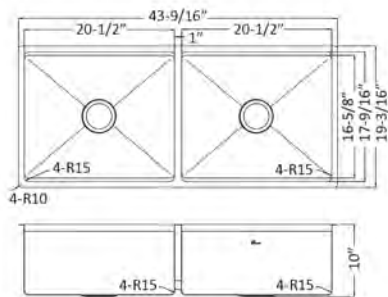
NEW

DSR421717 \$605.00 Small Corner Radius Equal Bowl
 Material: 304 Stainless Steel
 Content: 18/8 Chrome-Nickel
 Gauge: 18
 Finish: Polished Satin
 Size: 43-9/16" x 19-3/16" x 10"
 Drain Opening: 3-1/2"
 Undercoating: Padded
 Cutout Template included
 Limited Lifetime Warranty
 Minimum Cabinet Size: 45-9/16"

Optional Accessories:

Colander **COL710**
 Size: 17-7/16" x 10" x 1-1/4"
List \$144



Cutting Board **CB710**
 Size: 17-7/16" x 11-13/16" x 1-3/16"
List \$91



Tray **T710**
 Size: 12-13/16" x 17-1/2" x 5"
List \$204



Strainer **SD-01**
 Size: 4-5/8" x 3-1/2"
List \$18



Drain Mat **DM710**
 Size: 17-5/16" x 12-3/16" x 5/16"

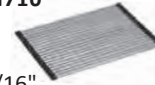

Strainer **SD-33**
 Size: 4-1/2" x 3-15/16"
List \$23

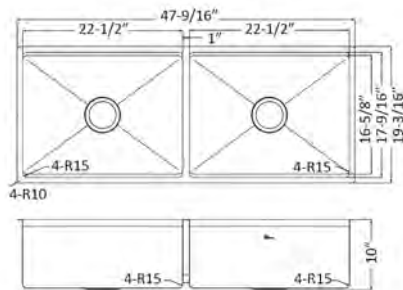

Strainer **SD-39**
 Size: 4-1/2" x 4-3/64"
List \$23

NEW

DSR481717 \$655.00 Small Corner Radius Equal Bowl
 Material: 304 Stainless Steel
 Content: 18/8 Chrome-Nickel
 Gauge: 18
 Finish: Polished Satin
 Size: 47-9/16" x 19-3/16" x 10"
 Drain Opening: 3-1/2"
 Undercoating: Padded
 Cutout Template included
 Limited Lifetime Warranty
 Minimum Cabinet Size: 49-9/16"

Optional Accessories:

Colander **COL710**
 Size: 17-7/16" x 10" x 1-1/4"
List \$144



Cutting Board **CB710**
 Size: 17-7/16" x 11-13/16" x 1-3/16"
List \$91



Tray **T710**
 Size: 12-13/16" x 17-1/2" x 5"
List \$204



Strainer **SD-01**
 Size: 4-5/8" x 3-1/2"
List \$18



Drain Mat **DM710**
 Size: 17-5/16" x 12-3/16" x 5/16"

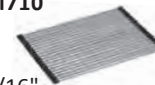

Strainer **SD-33**
 Size: 4-1/2" x 3-15/16"
List \$23



Strainer **SD-39**
 Size: 4-1/2" x 4-3/64"
List \$23



Undermount Small Radius Sinks

Model No.

List Price

Description

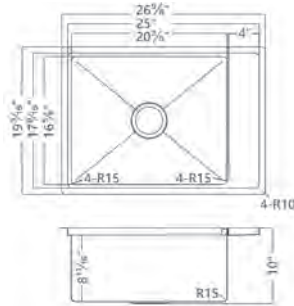

SRF251710

\$849.00

Small Corner Radius Single Bowl
Material: 304 Stainless Steel
Content: 18/8 Chrome-Nickel
Gauge: 18
Finish: Polished Satin
Size: 26-5/8" x 19-3/16" x 10"
Drain Opening: 3-1/2"
Undercoating: Padded
Cutout Template included
Limited Lifetime Warranty
Minimum Cabinet Size: 28-5/8"

Optional Accessories:

Utensil Shelf **T321710**
Size: 16-1/2" x 3-1/2"
x 1-5/8" **List \$88.00**

Basket **BK321710**
Size: 16-1/2" x 8-11/16" x 6"
List \$78.00



Strainer **SD-01**
Size: 4-5/8"
x 3-1/2"
List \$18



Cutting Board **CB710**
Size: 17-7/16" x
11-13/16" x 1-3/16"
List \$91



Premium Bottom Grid
G812 Size: 19-3/4" x
16-1/16" **List \$210.00**

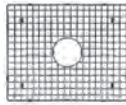

Colander **COL710**
Size: 17-7/16" x 10"
x 1-1/4" **List \$144**



Tray **T710**
Size: 12-13/16"
x 17-1/2" x 5"
List \$204



Drain Mat **DM710**
List \$128
Size: 17-5/16"
x 12-3/16" x 5/16"

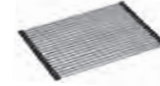

Strainer **SD-33**
Size: 4-1/2"
x 3-15/16"
List \$23



Strainer **SD-39**
Size: 4-1/2"
x 4-3/64"
List \$23

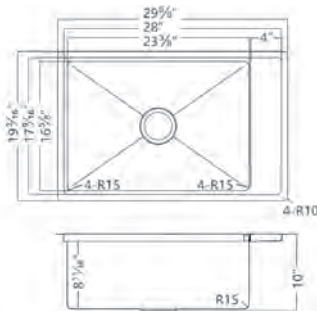

SRF281710

\$922.00

Small Corner Radius Single Bowl
Material: 304 Stainless Steel
Content: 18/8 Chrome-Nickel
Gauge: 18
Finish: Polished Satin
Size: 29-5/8" x 19-3/16" x 10"
Drain Opening: 3-1/2"
Undercoating: Padded
Cutout Template included
Limited Lifetime Warranty
Minimum Cabinet Size: 31-5/8"

Optional Accessories:

Utensil Shelf **T321710**
Size: 16-1/2" x 3-1/2"
x 1-5/8" **List \$88.00**

Basket **BK321710**
Size: 16-1/2" x 8-11/16" x 6"
List \$78.00



Strainer **SD-01**
Size: 4-5/8"
x 3-1/2"
List \$18



Cutting Board **CB710**
Size: 17-7/16" x
11-13/16" x 1-3/16"
List \$91



Premium Bottom Grid
G811 Size: 22-13/16" x
16-1/16" **List \$221.00**

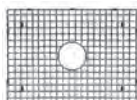

Colander **COL710**
Size: 17-7/16" x 10"
x 1-1/4" **List \$144**



Tray **T710**
Size: 12-13/16"
x 17-1/2" x 5"
List \$204



Drain Mat **DM710**
List \$128
Size: 17-5/16"
x 12-3/16" x 5/16"

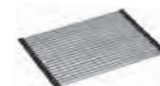

Strainer **SD-33**
Size: 4-1/2"
x 3-15/16"
List \$23



Strainer **SD-39**
Size: 4-1/2"
x 4-3/64"
List \$23



Undermount Small Radius Sinks Model No. List Price Description

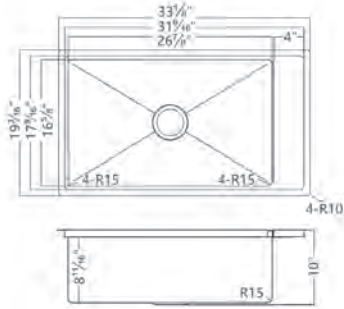

SRF321710 \$970.00

Small Corner Radius Single Bowl
 Material: 304 Stainless Steel
 Content: 18/8 Chrome-Nickel
 Gauge: 18
 Finish: Polished Satin
 Size: 33-1/8" x 19-3/16" x 10"
 Drain Opening: 3-1/2"
 Undercoating: Padded
 Cutout Template included
 Limited Lifetime Warranty
 Minimum Cabinet Size: 35-1/8"

Optional Accessories:

Utensil Shelf **T321710**
 Size: 16-1/2" x 3-1/2"
 x 1-5/8" **List \$88.00**

Basket **BK321710**
 Size: 16-1/2" x 8-11/16" x 6"
List \$78.00



Strainer **SD-01**
 Size: 4-5/8"
 x 3-1/2"
List \$18



Cutting Board **CB710**
 Size: 17-7/16" x
 11-13/16" x 1-3/16"
List \$91



Premium Bottom Grid **G810**
 Size: 26-9/16" x
 16-1/16" **List \$249**

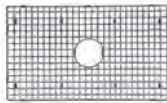

Colander **COL710**
 Size: 17-7/16" x 10"
 x 1-1/4" **List \$144**



Tray **T710**
 Size: 12-13/16"
 x 17-1/2" x 5"
List \$204



Drain Mat **DM710**
List \$128
 Size: 17-5/16"
 x 12-3/16" x 5/16"

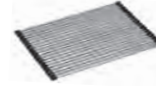

Strainer **SD-33**
 Size: 4-1/2"
 x 3-15/16"
List \$23



Strainer **SD-39**
 Size: 4-1/2"
 x 4-3/64"
List \$23



Undermount Small Radius Sinks Model No. List Price Description

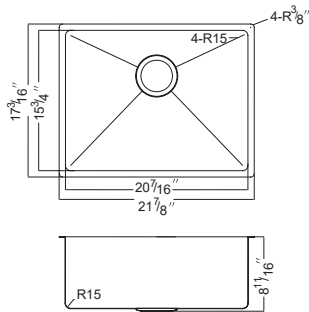

SRU201609-N \$303.00 Small Corner Radius Single Bowl
 Material: 304 Stainless Steel
 Content: 18/10 Chrome-Nickel
 Gauge: 18
 Finish: Polished Satin
 Size: 21-7/8" x 17-3/16" x 8-11/16"
 Drain Opening: 3-1/2"
 Undercoating: Padded
 Cutout Template included
 Limited Lifetime Warranty
 Minimum Cabinet Size: 23-7/8"

Optional Accessories:

Bottom Grid G080
 Size: 19-7/8" x 15-1/8"
List \$100

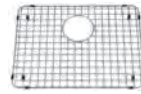

Strainer SD-01
 Size: 4-5/8" x 3-1/2"
List \$18



Strainer SD-33
 Size: 4-1/2" x 3-15/16"
List \$23



Drain Mat DM001
 Size: 19-11/16" x 12" x 5/16"
List \$176

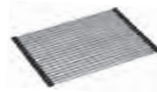

Strainer SD-39
 Size: 4-1/2" x 4-3/64"
List \$23



NEW

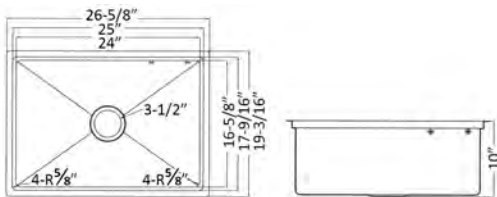

SRU241610-N \$550.00 Small Corner Radius Single Bowl
 Material: 304 Stainless Steel
 Content: 18/10 Chrome-Nickel
 Gauge: 18
 Finish: Polished Satin
 Size: 26-5/8" x 19-3/16" x 10"
 Drain Opening: 3-1/2"
 Undercoating: Padded
 Cutout Template included
 Limited Lifetime Warranty
 Minimum Cabinet Size: 28-5/8"

Optional Accessories:

Bottom Grid G713
 Size: 23-5/8" x 16-3/16"
List \$100.00

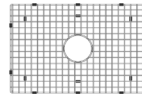

Cutting Board CB710
 Size: 17-7/16" x 11-13/16" x 1-3/16"
List \$91



Colander COL710
 Size: 17-7/16" x 10" x 1-1/4"
List \$144



Strainer SD-01
 Size: 4-5/8" x 3-1/2"
List \$18



Tray T710
 Size: 12-13/16" x 17-1/2" x 5"
List \$204



Strainer SD-33
 Size: 4-1/2" x 3-15/16"
List \$23



Drain Mat DM710
 List \$128
 Size: 17-5/16" x 12-3/16" x 5/16"

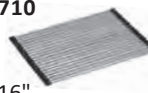

Strainer SD-39
 Size: 4-1/2" x 4-3/64"
List \$23



Included Accessory:
Basket BK710
 Size: 7-13/16" x 4" x 3-1/8"
List \$34



Undermount Small Radius Sinks Model No. List Price Description



SRU251610-N \$522.00

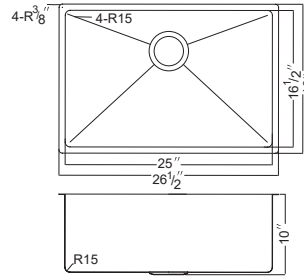

Small Corner Radius Single Bowl
 Material: 304 Stainless Steel
 Content: 18/10 Chrome-Nickel
 Gauge: 18
 Finish: Polished Satin
 Size: 26-1/2" x 18" x 10"
 Drain Opening: 3-1/2"
 Undercoating: Padded
 Cutout Template included
 Limited Lifetime Warranty
 Minimum Cabinet Size: 28-1/2"

Optional Accessories:

Bottom Grid **G610**
 Size: 24-1/2" x 16"
 List \$110

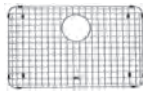

Drain Mat **DM001**
 Size: 19-11/16" x 12" x 5/16"
 List \$176

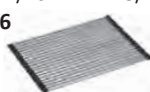

Strainer **SD-01**
 Size: 4-5/8" x 3-1/2"
 List \$18



Strainer **SD-33**
 Size: 4-1/2" x 3-15/16"
 List \$23



Strainer **SD-39**
 Size: 4-1/2" x 4-3/64"
 List \$23



SRU271610-N \$530.00

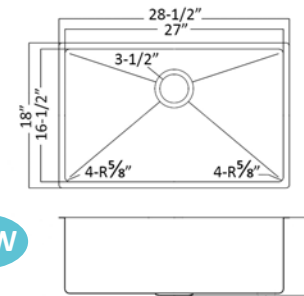

Small Corner Radius Single Bowl
 Material: 304 Stainless Steel
 Content: 18/10 Chrome-Nickel
 Gauge: 18
 Finish: Polished Satin
 Size: 28-1/2" x 18" x 10"
 Drain Opening: 3-1/2"
 Undercoating: Padded
 Cutout Template included
 Limited Lifetime Warranty
 Minimum Cabinet Size: 30-1/2"

Optional Accessories:

Bottom Grid **G712**
 Size: 26-9/16" x 16-1/16"
 List \$105

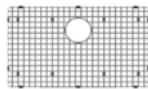

Drain Mat **DM001**
 Size: 19-11/16" x 12" x 5/16"
 List \$176

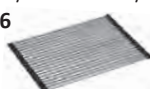

Strainer **SD-01**
 Size: 4-5/8" x 3-1/2"
 List \$18



Strainer **SD-33**
 Size: 4-1/2" x 3-15/16"
 List \$23



Strainer **SD-39**
 Size: 4-1/2" x 4-3/64"
 List \$23



SRU301610-N \$550.00

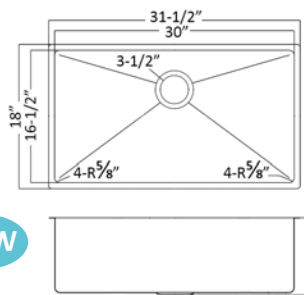

Small Corner Radius Single Bowl
 Material: 304 Stainless Steel
 Content: 18/10 Chrome-Nickel
 Gauge: 18
 Finish: Polished Satin
 Size: 31-1/2" x 18" x 10"
 Drain Opening: 3-1/2"
 Undercoating: Padded
 Cutout Template included
 Limited Lifetime Warranty
 Minimum Cabinet Size: 33-1/2"

Optional Accessories:

Bottom Grid **G711**
 Size: 29-1/2" x 16-1/16"
 List \$150

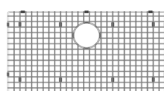

Drain Mat **DM001**
 Size: 19-11/16" x 12" x 5/16"
 List \$176

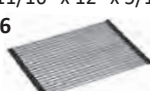

Strainer **SD-01**
 Size: 4-5/8" x 3-1/2"
 List \$18



Strainer **SD-33**
 Size: 4-1/2" x 3-15/16"
 List \$23



Strainer **SD-39**
 Size: 4-1/2" x 4-3/64"
 List \$23



Undermount Small Radius Sinks

Model No. List Price Description

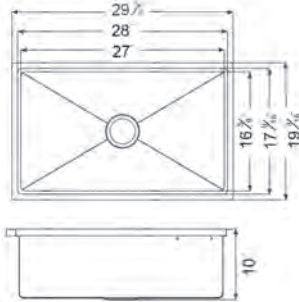

Included Accessory:

Basket BK710
Size: 7-13/16" x 4" x 3-1/8"
List \$34



SRU281610 \$970.00 Small Corner Radius Single Bowl
Material: 304 Stainless Steel
Content: 18/10 Chrome-Nickel
Gauge: 18
Finish: Polished Satin
Size: 29-5/8" x 19-3/16" x 10"
Drain Opening: 3-1/2"
Undercoating: Padded
Cutout Template included
Limited Lifetime Warranty
Minimum Cabinet Size: 31-5/8"

Optional Accessories:

Premium Bottom Grid G810
Size: 26-9/16" x 16-1/16"
List \$249.00

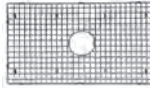

Cutting Board CB710
Size: 17-7/16" x 11-13/16" x 1-3/16"
List \$91



Colander COL710
Size: 17-7/16" x 10" x 1-1/4"
List \$144



Strainer SD-01
Size: 4-5/8" x 3-1/2"
List \$18



Tray T710
Size: 12-13/16" x 17-1/2" x 5"
List \$204



Strainer SD-33
Size: 4-1/2" x 3-15/16"
List \$23



Drain Mat DM710
List \$128
Size: 17-5/16" x 12-3/16" x 5/16"

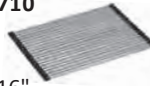

Strainer SD-39
Size: 4-1/2" x 4-3/64"
List \$23

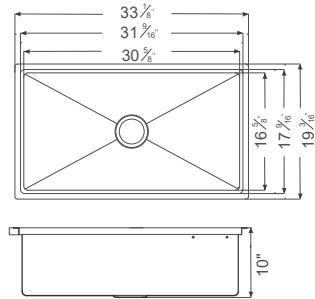

Included Accessory:

Basket BK710
Size: 7-13/16" x 4" x 3-1/8"
List \$34



SRU311710 \$1,074.00 Small Corner Radius Single Bowl
Material: 304 Stainless Steel
Content: 18/10 Chrome-Nickel
Gauge: 18
Finish: Polished Satin
Size: 33-1/8" x 19-3/16" x 10"
Drain Opening: 3-1/2"
Undercoating: Padded
Cutout Template included
Limited Lifetime Warranty
Minimum Cabinet Size: 35-1/8"

Optional Accessories:

Premium Bottom Grid G710
Size: 30-1/8" x 16-1/16"
List \$306

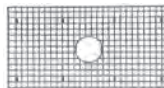

Cutting Board CB710
Size: 17-7/16" x 11-13/16" x 1-3/16"
List \$91



Colander COL710
Size: 17-7/16" x 10" x 1-1/4"
List \$144



Strainer SD-01
Size: 4-5/8" x 3-1/2"
List \$18



Tray T710
Size: 12-13/16" x 17-1/2" x 5"
List \$204



Strainer SD-33
Size: 4-1/2" x 3-15/16"
List \$23



Drain Mat DM710
List \$128
Size: 17-5/16" x 12-3/16" x 5/16"

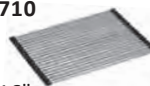

Strainer SD-39
Size: 4-1/2" x 4-3/64"
List \$23



Dawn®

Sinks



Undermount Small Radius Sinks

Model No. List Price Description

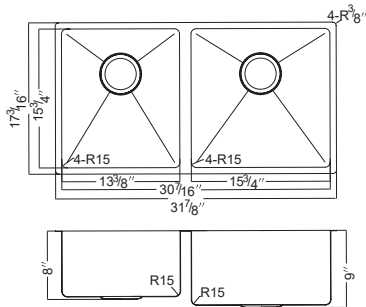

SRU301616L-N \$522.00 Small Corner Radius Double Bowl (Small Bowl on Left)
 Material: 304 Stainless Steel
 Content: 18/10 Chrome-Nickel
 Gauge: 18
 Finish: Polished Satin
 Size: 31-7/8" x 17-3/16" x 9"
 Drain Opening: 3-1/2"
 Undercoating: Padded
 Cutout Template included
 Limited Lifetime Warranty
 Minimum Cabinet Size: 33-7/8"

Optional Accessories:

Bottom Grid **G082** (Small Bowl)
 Size: 12-7/8" x 15-1/4"
List \$76



Drain Mat **DM001**
 Size: 19-11/16" x 12" x 5/16"
List \$176

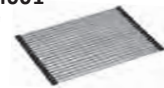

Strainer **SD-01**
 Size: 4-5/8" x 3-1/2"
List \$18



Bottom Grid **G083** (Large Bowl)
 Size: 15-1/4" x 15-1/4"
List \$82

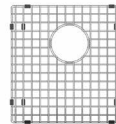

Strainer **SD-33**
 Size: 4-1/2" x 3-15/16"
List \$23



Strainer **SD-39**
 Size: 4-1/2" x 4-3/64"
List \$23

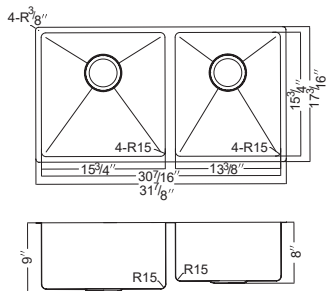

SRU301616R-N \$522.00 Small Corner Radius Double Bowl (Small Bowl on Right)
 Material: 304 Stainless Steel
 Content: 18/10 Chrome-Nickel
 Gauge: 18
 Finish: Polished Satin
 Size: 31-7/8" x 17-3/16" x 9"
 Drain Opening: 3-1/2"
 Undercoating: Padded
 Cutout Template included
 Limited Lifetime Warranty
 Minimum Cabinet Size: 33-7/8"

Optional Accessories:

Bottom Grid **G082** (Small Bowl)
 Size: 12-7/8" x 15-1/4"
List \$76



Drain Mat **DM001**
 Size: 19-11/16" x 12" x 5/16"
List \$176

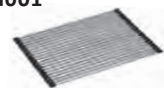

Strainer **SD-01**
 Size: 4-5/8" x 3-1/2"
List \$18



Bottom Grid **G083** (Large Bowl)
 Size: 15-1/4" x 15-1/4"
List \$82

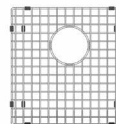

Strainer **SD-33**
 Size: 4-1/2" x 3-15/16"
List \$23



Strainer **SD-39**
 Size: 4-1/2" x 4-3/64"
List \$23



Undermount Small Radius Sinks Model No. List Price Description



SRU311317L \$522.00 Small Corner Radius Double Bowl (Small Bowl on Left)
 Material: 304 Stainless Steel
 Content: 18/10 Chrome-Nickel
 Gauge: 18
 Finish: Polished Satin
 Size: 33" x 18-1/2" x 10"
 Drain Opening: 3-1/2"
 Undercoating: Padded
 Cutout Template included
 Limited Lifetime Warranty
 Minimum Cabinet Size: 35"

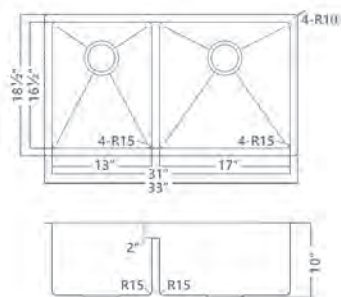

Optional Accessories:

Cutting Board CB019
 Size: 18-3/8" x 11-3/4"
 1-1/8"
List \$87



Drain Mat DM001
 Size: 19-11/16" x 12" x 5/16"
List \$176

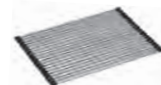

Strainer SD-01
 Size: 4-5/8" x 3-1/2"
List \$18



Strainer SD-33
 Size: 4-1/2" x 3-15/16"
List \$23



Strainer SD-39
 Size: 4-1/2" x 4-3/64"
List \$23



SRU331616-N \$532.00 Small Corner Radius Double Bowl (Equal Double Bowl)
 Material: 304 Stainless Steel
 Content: 18/10 Chrome-Nickel
 Gauge: 18
 Finish: Polished Satin
 Size: 34-3/16" x 17-3/16" x 9"
 Drain Opening: 3-1/2"
 Undercoating: Padded
 Cutout Template included
 Limited Lifetime Warranty
 Minimum Cabinet Size: 36-3/16"

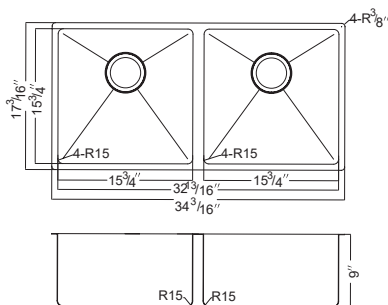

Optional Accessories:

Bottom Grid G083
 Size: 15-1/4" x 15-1/4"
List \$82

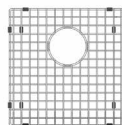

Drain Mat DM001
 Size: 19-11/16" x 12" x 5/16"
List \$176

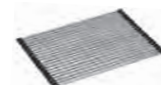

Strainer SD-01
 Size: 4-5/8" x 3-1/2"
List \$18



Strainer SD-33
 Size: 4-1/2" x 3-15/16"
List \$23



Strainer SD-39
 Size: 4-1/2" x 4-3/64"
List \$23



Undermount Extra Small Radius Sinks

Model No.

List Price

Description

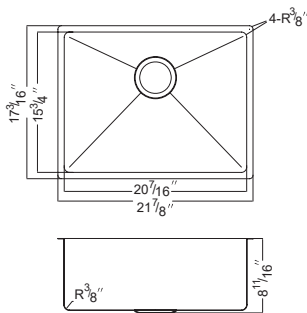

XSR201609

\$485.00

Extra Small Corner Radius Single Bowl
 Material: 304 Stainless Steel
 Content: 18/8 Chrome-Nickel
 Gauge: 16
 Finish: Polished Satin
 Size: 21-7/8" x 17-3/16" x 8-11/16"
 Drain Opening: 3-1/2"
 Undercoating: Padded
 Cutout Template included
 Limited Lifetime Warranty
 Minimum Cabinet Size: 23-7/8"

Optional Accessories:

Bottom Grid **G080**

Size: 19-7/8" x 15-1/8"

List \$100

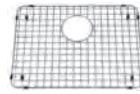

Strainer **SD-01**

Size: 4-5/8" x 3-1/2"

List \$18



Strainer **SD-33**

Size: 4-1/2" x 3-15/16"

List \$23



Drain Mat **DM001**

Size: 19-11/16" x 12" x 5/16"

List \$176

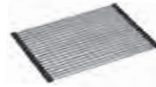

Strainer **SD-39**

Size: 4-1/2" x 4-3/64"

List \$23

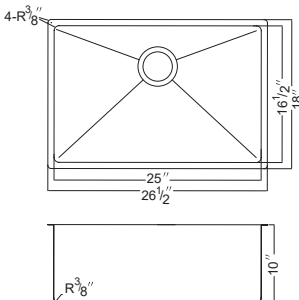

XSR251610

\$546.00

Extra Small Corner Radius Single Bowl
 Material: 304 Stainless Steel
 Content: 18/8 Chrome-Nickel
 Gauge: 16
 Finish: Polished Satin
 Size: 26-1/2" x 18" x 10"
 Drain Opening: 3-1/2"
 Undercoating: Padded
 Cutout Template included
 Limited Lifetime Warranty
 Minimum Cabinet Size: 28-1/2"

Optional Accessories:

Bottom Grid **G610**

Size: 24-1/2" x 16"

List \$110

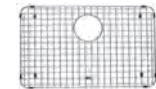

Strainer **SD-01**

Size: 4-5/8" x 3-1/2"

List \$18



Strainer **SD-33**

Size: 4-1/2" x 3-15/16"

List \$23



Drain Mat **DM001**

Size: 19-11/16" x 12" x 5/16"

List \$176

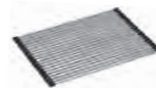

Strainer **SD-39**

Size: 4-1/2" x 4-3/64"

List \$23



Undermount Extra Small Radius Sinks Model No. List Price Description

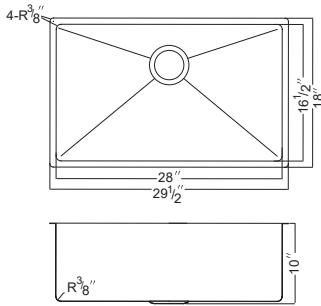

XSR281610 \$583.00

Extra Small Corner Radius Single Bowl
 Material: 304 Stainless Steel
 Content: 18/8 Chrome-Nickel
 Gauge: 16
 Finish: Polished Satin
 Size: 29-1/2" x 18" x 10"
 Drain Opening: 3-1/2"
 Undercoating: Padded
 Cutout Template included
 Limited Lifetime Warranty
 Minimum Cabinet Size: 31-1/2"

Optional Accessories:

Premium Bottom Grid **G061**
 Size: 27-5/8" x 15-9/16"
List \$260

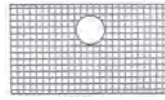

Strainer **SD-01**
 Size: 4-5/8" x 3-1/2"
List \$18



Strainer **SD-33**
 Size: 4-1/2" x 3-15/16"
List \$23



Drain Mat **DM001**
 Size: 19-11/16" x 12" x 5/16"
List \$176

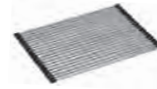

Strainer **SD-39**
 Size: 4-1/2" x 4-3/64"
List \$23

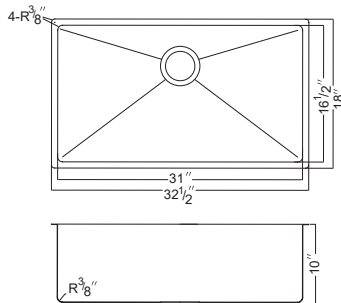

XSR311610 \$644.00

Extra Small Corner Radius Single Bowl
 Material: 304 Stainless Steel
 Content: 18/8 Chrome-Nickel
 Gauge: 16
 Finish: Polished Satin
 Size: 32-1/2" x 18" x 10"
 Drain Opening: 3-1/2"
 Undercoating: Padded
 Cutout Template included
 Limited Lifetime Warranty
 Minimum Cabinet Size: 34-1/2"

Optional Accessories:

Premium Bottom Grid **G060**
 Size: 30-5/8" x 15-9/16"
List \$309

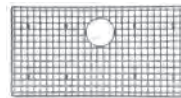

Strainer **SD-01**
 Size: 4-5/8" x 3-1/2"
List \$18



Strainer **SD-33**
 Size: 4-1/2" x 3-15/16"
List \$23



Drain Mat **DM001**
 Size: 19-11/16" x 12" x 5/16"
List \$176

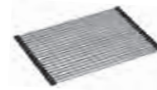

Strainer **SD-39**
 Size: 4-1/2" x 4-3/64"
List \$23



Undermount Extra Small Radius Sinks **Model No.** **List Price** **Description**



XSR321616 **\$607.00**

Extra Small Corner Radius Double Bowl (Equal Double Bowl)
 Material: 304 Stainless Steel
 Content: 18/8 Chrome-Nickel
 Gauge: 16
 Finish: Polished Satin
 Size: 34-3/16" x 17-3/16" x 9"
 Drain Opening: 3-1/2"
 Undercoating: Padded
 Cutout Template included
 Limited Lifetime Warranty
 Minimum Cabinet Size: 36-3/16"

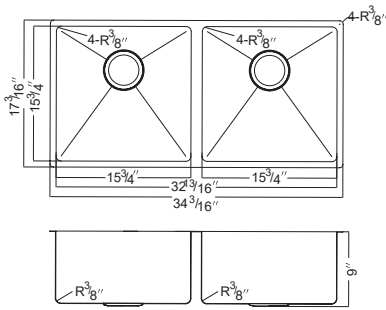

Optional Accessories:

Bottom Grid G083
 Size: 15-1/4" x 15-1/4"
List \$82

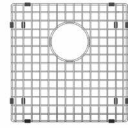

Drain Mat DM001
 Size: 19-11/16" x 12" x 5/16"
List \$176

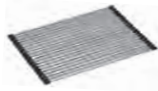

Strainer SD-01
 Size: 4-5/8" x 3-1/2"
List \$18



Strainer SD-33
 Size: 4-1/2" x 3-15/16"
List \$23



Strainer SD-39
 Size: 4-1/2" x 4-3/64"
List \$23



Undermount Extra Small Radius Sinks

Model No. List Price Description



XSR311816L \$607.00

Extra Small Corner Radius Double Bowl (Small Bowl on Left)
 Material: 304 Stainless Steel
 Content: 18/8 Chrome-Nickel
 Gauge: 16
 Finish: Polished Satin
 Size: 33" x 20-1/2" x 10-1/2"
 Drain Opening: 3-1/2"
 Undercoating: Padded
 Cutout Template included
 Limited Lifetime Warranty
 Minimum Cabinet Size: 35"

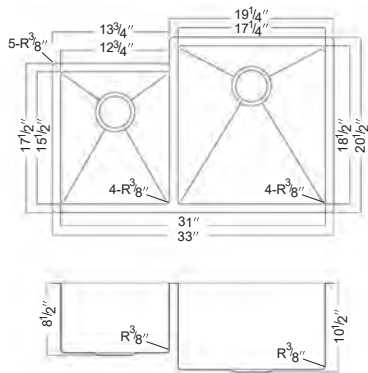

Optional Accessories:

Drain Mat **DM001**
 Size: 19-11/16" x 12" x 5/16"
 List \$176

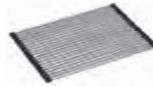

Strainer **SD-01**
 Size: 4-5/8" x 3-1/2"
 List \$18



Strainer **SD-33**
 Size: 4-1/2" x 3-15/16"
 List \$23



Strainer **SD-39**
 Size: 4-1/2" x 4-3/64"
 List \$23



XSR311816R \$607.00

Extra Small Corner Radius Double Bowl (Small Bowl on Right)
 Material: 304 Stainless Steel
 Content: 18/8 Chrome-Nickel
 Gauge: 16
 Finish: Polished Satin
 Size: 33" x 20-1/2" x 10-1/2"
 Drain Opening: 3-1/2"
 Undercoating: Padded
 Cutout Template included
 Limited Lifetime Warranty
 Minimum Cabinet Size: 35"

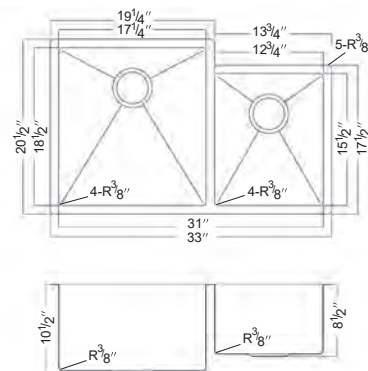

Optional Accessories:

Drain Mat **DM001**
 Size: 19-11/16" x 12" x 5/16"
 List \$176

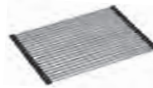

Strainer **SD-01**
 Size: 4-5/8" x 3-1/2"
 List \$18



Strainer **SD-33**
 Size: 4-1/2" x 3-15/16"
 List \$23



Strainer **SD-39**
 Size: 4-1/2" x 4-3/64"
 List \$23



Undermount Extra Small Radius Sinks

Model No.

List Price

Description



XSR421610 \$728.00

Extra Small Corner Radius Single Bowl
 Material: 304 Stainless Steel
 Content: 18/8 Chrome-Nickel
 Gauge: 16
 Finish: Polished Satin
 Size: 44" x 18-1/2" x 10"
 Drain Opening: 3-1/2"
 Undercoating: Padded
 Cutout Template included
 Limited Lifetime Warranty
 Minimum Cabinet Size: 46"

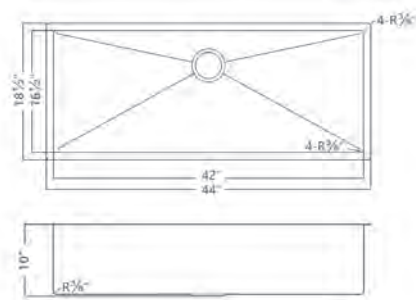

Optional Accessories:

Drain Mat DM001
 Size: 19-11/16" x 12" x 5/16"
List \$176

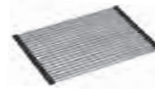

Strainer SD-01
 Size: 4-5/8" x 3-1/2"
List \$18



Strainer SD-33
 Size: 4-1/2" x 3-15/16"
List \$23



Strainer SD-39
 Size: 4-1/2" x 4-3/64"
List \$23



XSR421616 \$825.00

Extra Small Corner Radius Equal Bowl
 Material: 304 Stainless Steel
 Content: 18/8 Chrome-Nickel
 Gauge: 16
 Finish: Polished Satin
 Size: 44" x 18-1/2" x 10"
 Drain Opening: 3-1/2"
 Undercoating: Padded
 Cutout Template included
 Limited Lifetime Warranty
 Minimum Cabinet Size: 46"

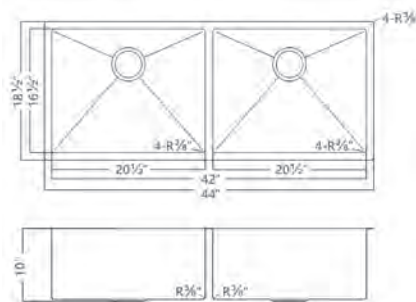

Optional Accessories:

Drain Mat DM001
 Size: 19-11/16" x 12" x 5/16"
List \$176

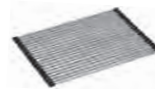

Strainer SD-01
 Size: 4-5/8" x 3-1/2"
List \$18



Strainer SD-33
 Size: 4-1/2" x 3-15/16"
List \$23



Strainer SD-39
 Size: 4-1/2" x 4-3/64"
List \$23





Undermount Square Sinks

Model No.

List Price

Description

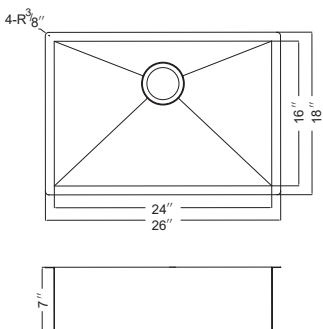

DSQ241607 \$485.00

Square Single Bowl Sink
 Material: 304 Stainless Steel
 Content: 18/10 Chrome-Nickel
 Gauge: 18
 Finish: Polished Satin
 Size: 26" x 18" x 7"
 Drain Opening: 3-1/2"
 Undercoating: Padded
 Cutout Template included
 Limited Lifetime Warranty
 Minimum Cabinet Size: 28"

Optional Accessories:

Premium Bottom Grid **G062**
 Size: 23-9/16" x 15-9/16"
List \$237

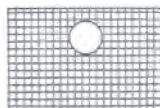

Strainer **SD-01**
 Size: 4-5/8" x 3-1/2"
List \$18



Strainer **SD-33**
 Size: 4-1/2" x 3-15/16"
List \$23



Drain Mat **DM001**
 Size: 19-11/16" x 12" x 5/16"
List \$176

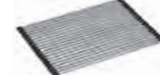

Strainer **SD-39**
 Size: 4-1/2" x 4-3/64"
List \$23

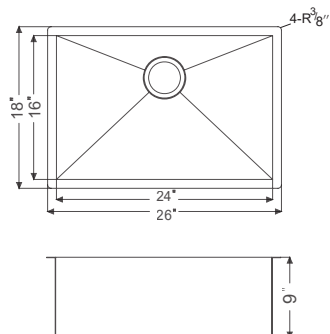

DSQ241609 \$522.00

Square Single Bowl Sink
 Material: 304 Stainless Steel
 Content: 18/10 Chrome-Nickel
 Gauge: 18
 Finish: Polished Satin
 Size: 26" x 18" x 9"
 Drain Opening: 3-1/2"
 Undercoating: Padded
 Cutout Template included
 Limited Lifetime Warranty
 Minimum Cabinet Size: 28"

Optional Accessories:

Premium Bottom Grid **G062**
 Size: 23-9/16" x 15-9/16"
List \$237

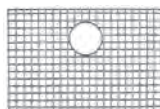

Strainer **SD-01**
 Size: 4-5/8" x 3-1/2"
List \$18



Strainer **SD-33**
 Size: 4-1/2" x 3-15/16"
List \$23



Drain Mat **DM001**
 Size: 19-11/16" x 12" x 5/16"
List \$176

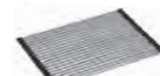

Strainer **SD-39**
 Size: 4-1/2" x 4-3/64"
List \$23



Undermount Square Sinks Model No. List Price Description

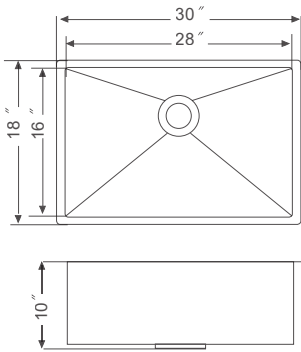

DSQ2816 \$631.00 Square Single Bowl Sink
 Material: 304 Stainless Steel
 Content: 18/10 Chrome-Nickel
 Gauge: 18
 Finish: Polished Satin
 Size: 30" x 18" x 10"
 Drain Opening: 3-1/2"
 Undercoating: Padded
 Cutout Template included
 Limited Lifetime Warranty
 Minimum Cabinet Size: 32"

Optional Accessories:

Premium Bottom Grid G061
 Size: 27-5/8" x 15-9/16"
List \$260

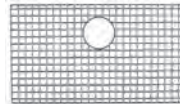

Drain Mat DM001
 Size: 19-11/16" x 12" x 5/16"
List \$176

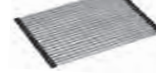

Strainer SD-01
 Size: 4-5/8" x 3-1/2"
List \$18



Strainer SD-33
 Size: 4-1/2" x 3-15/16"
List \$23



Strainer SD-39
 Size: 4-1/2" x 4-3/64"
List \$23

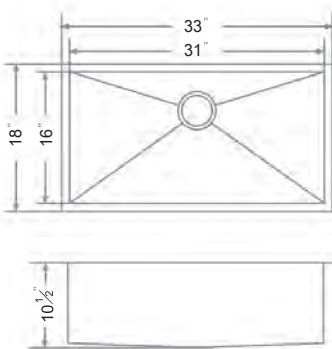

DSQ3116 \$690.00 Square Single Bowl Sink
 Material: 304 Stainless Steel
 Content: 18/10 Chrome-Nickel
 Gauge: 18
 Finish: Polished Satin
 Size: 33" x 18" x 10-1/2"
 Drain Opening: 3-1/2"
 Undercoating: Padded
 Cutout Template included
 Limited Lifetime Warranty
 Minimum Cabinet Size: 35"

Optional Accessories:

Premium Bottom Grid G060
 Size: 30-5/8" x 15-9/16"
List \$309

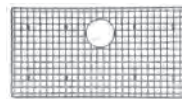

Drain Mat DM001
 Size: 19-11/16" x 12" x 5/16"
List \$176

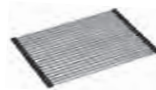

Strainer SD-01
 Size: 4-5/8" x 3-1/2"
List \$18



Strainer SD-33
 Size: 4-1/2" x 3-15/16"
List \$23



Strainer SD-39
 Size: 4-1/2" x 4-3/64"
List \$23





DUAL MOUNT

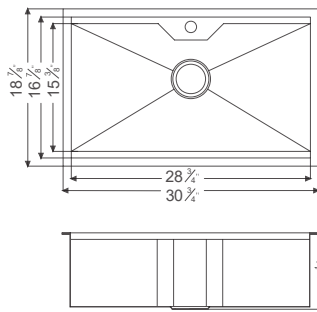

DSQ2817

\$922.00

Square Single Bowl Sink
Dual Mount
Material: 304 Stainless Steel
Content: 18/10 Chrome-Nickel
Gauge: 18
Finish: Polished Satin
Size: 30-3/4" x 18-7/8" x 9-1/2"
Drain Opening: 3-1/2"
Undercoating: Padded
Cutout Template included
Limited Lifetime Warranty
Minimum Cabinet Size: 32-3/4"

Optional Accessories:

Cutting Board **CB017**
Size: 18-3/8" x 11-3/4"
x 1-1/8"
List **\$87**



Drain Mat **DM018**
Size: 16-1/2"
x 12-3/16"
x 5/16"
List **\$117**

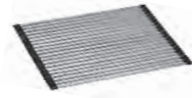

Colander **COL018**
Size: 16-3/4" x 9"
x 4-3/4"
List **\$186**



Strainer **SD-01**
Size: 4-5/8" x 3-1/2"
List **\$18**



Tray **T817**
Size: 16-3/4"
x 11" x 5-3/8"
List **\$162**



Strainer **SD-33**
Size: 4-1/2" x 3-15/16"
List **\$23**



Strainer **SD-39**
Size: 4-1/2" x 4-3/64"
List **\$23**



DUAL MOUNT

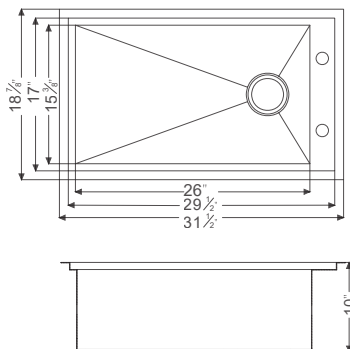

DSQ2917

\$1,100.00

Square Single Bowl Sink
Dual Mount
Material: 304 Stainless Steel
Content: 18/10 Chrome-Nickel
Gauge: 18
Finish: Polished Satin
Size: 31-1/2" x 18-7/8" x 10"
Drain Opening: 3-1/2"
Undercoating: Padded
Cutout Template included
Limited Lifetime Warranty
Minimum Cabinet Size: 33-1/2"

Optional Accessories:

Cutting Board **CB017**
Size: 18-3/8" x 11-3/4"
x 1-1/8"
List **\$87**



Strainer **SD-01**
Size: 4-5/8" x 3-1/2"
List **\$18**



Colander **COL018**
Size: 16-3/4" x 9"
x 4-3/4"
List **\$186**



Strainer **SD-33**
Size: 4-1/2" x 3-15/16"
List **\$23**



Strainer **SD-39**
Size: 4-1/2" x 4-3/64"
List **\$23**



Drain Mat **DM018**
Size: 16-1/2" x
12-3/16" x 5/16"
List **\$117**

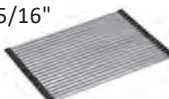

Undermount Square Sinks

Model No.

List Price

Description

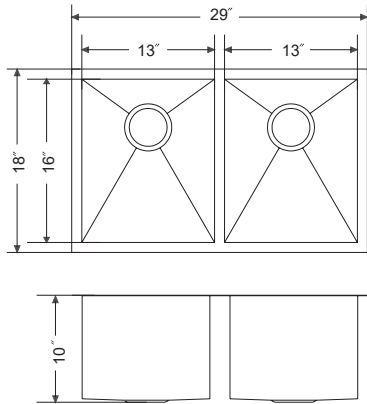
DSQ271616 \$983.00

Square Equal Double Bowl Sink
 Material: 304 Stainless Steel
 Content: 18/10 Chrome-Nickel
 Gauge: 18
 Finish: Polished Satin
 Size: 29" x 18" x 10"
 Drain Opening: 3-1/2"
 Undercoating: Padded
 Cutout Template included
 Limited Lifetime Warranty
 Minimum Cabinet Size: 31"

Optional Accessories:

Drain Mat **DM001**
 Size: 19-11/16" x 12" x 5/16"
 List \$176

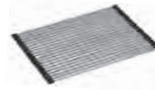

Strainer **SD-01**
 Size: 4-5/8" x 3-1/2"
 List \$18



Strainer **SD-33**
 Size: 4-1/2" x 3-15/16"
 List \$23

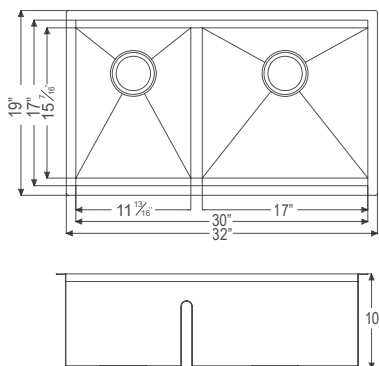

Strainer **SD-39**
 Size: 4-1/2" x 4-3/64"
 List \$23

DSQ301515 \$983.00

Square Double Bowl Sink
 (Small Bowl on Left)
 Material: 304 Stainless Steel
 Content: 18/10 Chrome-Nickel
 Gauge: 18
 Finish: Polished Satin
 Size: 32" x 19" x 10"
 Drain Opening: 3-1/2"
 Undercoating: Padded
 Cutout Template included
 Limited Lifetime Warranty
 Minimum Cabinet Size: 34"

Optional Accessories:

Cutting Board **CB017**
 Size: 18-3/8" x
 11-3/4" x 1-1/8"
 List \$87



Drain Mat **DM018**
 Size: 16-1/2" x
 12-3/16" x 5/16"
 List \$117



Bottom Grid **G063**
 (Small Bowl)
 Size: 11-3/8" x 15"
 List \$104

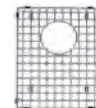

Strainer **SD-01**
 Size: 4-5/8" x 3-1/2"
 List \$18



Bottom Grid **G064**
 (Large Bowl)
 Size: 16-1/2" x 15"
 List \$134

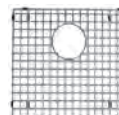

Strainer **SD-33**
 Size: 4-1/2" x 3-15/16"
 List \$23



Colander **COL018**
 Size: 16-3/4" x 9"
 x 4-3/4"
 List \$186



Strainer **SD-39**
 Size: 4-1/2" x 4-3/64"
 List \$23



Undermount Square Sinks

Model No. List Price Description

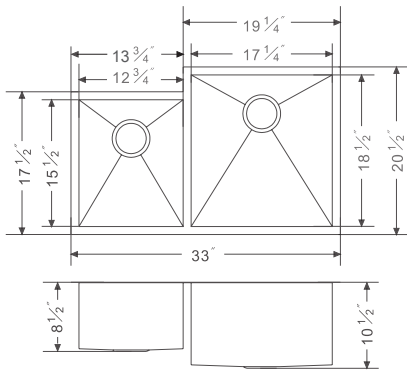

DSQ311815L \$929.00

Square Double Bowl Sink (Small Bowl on Left)
 Material: 304 Stainless Steel
 Content: 18/10 Chrome-Nickel
 Gauge: 18
 Finish: Polished Satin
 Size: 33" x 20-1/2" x 10-1/2"(B), 8-1/2(S)
 Drain Opening: 3-1/2"
 Undercoating: Padded
 Cutout Template included
 Limited Lifetime Warranty
 Minimum Cabinet Size: 35"

Optional Accessories:

Drain Mat DM001
 Size: 19-11/16" x 12" x 5/16"
List \$176

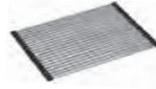

Strainer SD-01
 Size: 4-5/8" x 3-1/2"
List \$18



Strainer SD-33
 Size: 4-1/2" x 3-15/16"
List \$23



Strainer SD-39
 Size: 4-1/2" x 4-3/64"
List \$23

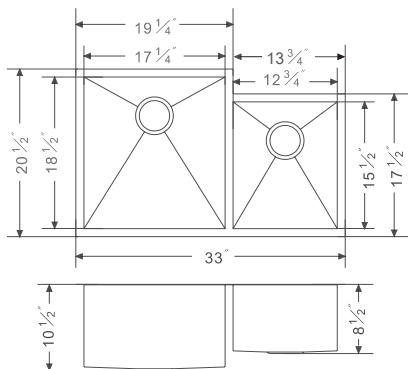

DSQ311815R \$929.00

Square Double Bowl Sink (Small Bowl on Right)
 Material: 304 Stainless Steel
 Content: 18/10 Chrome-Nickel
 Gauge: 18
 Finish: Polished Satin
 Size: 33" x 20-1/2" x 10-1/2"(B), 8-1/2(S)
 Drain Opening: 3-1/2"
 Undercoating: Padded
 Cutout Template included
 Limited Lifetime Warranty
 Minimum Cabinet Size: 35"

Optional Accessories:

Drain Mat DM001
 Size: 19-11/16" x 12" x 5/16"
List \$176

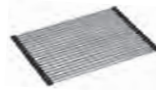

Strainer SD-01
 Size: 4-5/8" x 3-1/2"
List \$18



Strainer SD-33
 Size: 4-1/2" x 3-15/16"
List \$23



Strainer SD-39
 Size: 4-1/2" x 4-3/64"
List \$23



Undermount Square Sinks Model No. List Price Description

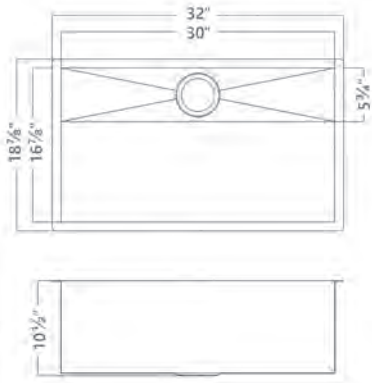

DSQD301610 \$970.00

Square Single Bowl Sink
 Material: 304 Stainless Steel
 Content: 18/10 Chrome-Nickel
 Gauge: 18
 Finish: Polished Satin
 Size: 32" x 18-7/8" x 10-1/2"
 Drain Opening: 3-1/2"
 Undercoating: Padded
 Cutout Template included
 Limited Lifetime Warranty
 Minimum Cabinet Size: 34"

Included Accessory:

Filter Board **DB301610** (x2)
 Size: 15" x 5-3/4" x 3/4"
List \$106



Optional Accessories:

Drain Mat **DM001**
 Size: 19-11/16" x 12" x 5/16"
List \$176

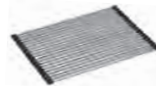

Strainer **SD-01**
 Size: 4-5/8" x 3-1/2"
List \$18



Strainer **SD-33**
 Size: 4-1/2" x 3-15/16"
List \$23











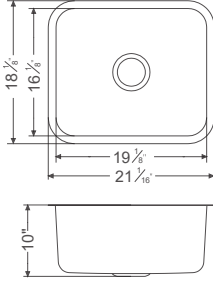

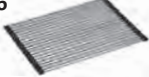



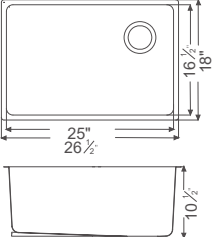
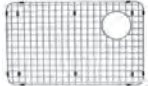
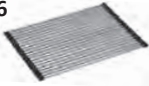

Strainer **SD-39**
 Size: 4-1/2" x 4-3/64"
List \$23

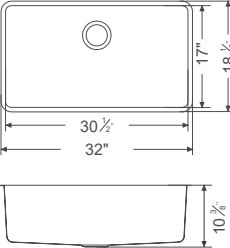

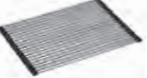
Sinks



Undermount DSU Sinks		Model No.	List Price	Description	
	DSU1916 \$522.00	Single Bowl Sink Material: 304 Stainless Steel Content: 18/10 Chrome-Nickel Gauge: 16 Finish: Polished Satin Size: 21-1/16" x 18-1/8" x 10" Drain Opening: 3-1/2" Undercoating: Padded Cutout Template included Limited Lifetime Warranty Minimum Cabinet Size: 23-1/16"			
	Optional Accessories:				
Bottom Grid G038 Size: 17-1/2" x 14-1/2" List \$100	Drain Mat DM001 Size: 19-11/16" x 12" x 5/16" List \$176	Strainer SD-01 Size: 4-5/8" x 3-1/2" List \$18	Strainer SD-33 Size: 4-1/2" x 3-15/16" List \$23	Strainer SD-39 Size: 4-1/2" x 4-3/64" List \$23	
					
	DSU2517 \$692.00	Single Bowl with Small Corner Radius and Rear Corner Drain Material: 304 Stainless Steel Content: 18/10 Chrome-Nickel Gauge: 16 Finish: Polished Satin Size: 26-1/2" x 18" x 10-1/2" Drain Opening: 3-1/2" Undercoating: Padded Cutout Template included Limited Lifetime Warranty Minimum Cabinet Size: 28-1/2"			
	Optional Accessories:				
Bottom Grid G517 Size: 23-7/16" x 15" List \$114	Drain Mat DM001 Size: 19-11/16" x 12" x 5/16" List \$176	Strainer SD-01 Size: 4-5/8" x 3-1/2" List \$18	Strainer SD-33 Size: 4-1/2" x 3-15/16" List \$23	Strainer SD-39 Size: 4-1/2" x 4-3/64" List \$23	
					
	DSU3017 \$898.00	Single Bowl with Small Corner Radius Material: 304 Stainless Steel Content: 18/10 Chrome-Nickel Gauge: 16 Finish: Polished Satin Size: 32" x 18-1/2" x 10-3/8" Drain Opening: 3-1/2" Undercoating: Padded Cutout Template included Limited Lifetime Warranty Minimum Cabinet Size: 34"			
	Optional Accessories:				
Cutting Board CB017 Size: 18-3/8" x 11-3/4" x 1-1/8" List \$87	Bottom Grid G031 Size: 28-5/8" x 15-1/4" List \$122	Drain Mat DM001 Size: 19-11/16" x 12" x 5/16" List \$176	Strainer SD-01 Size: 4-5/8" x 3-1/2" List \$18	Strainer SD-33 Size: 4-1/2" x 3-15/16" List \$23	Strainer SD-39 Size: 4-1/2" x 4-3/64" List \$23
					

Undermount DSU Sinks

Model No. List Price Description



DSU3018 \$946.00

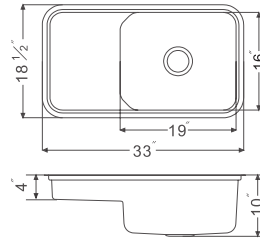

Single Bowl with Stepped Basin
 Material: 304 Stainless Steel
 Content: 18/10 Chrome-Nickel
 Gauge: 18
 Finish: Polished Satin
 Size: 33" x 18-1/2" x 10"
 Drain Opening: 3-1/2"
 Undercoating: Padded
 Cutout Template included
 Limited Lifetime Warranty
 Minimum Cabinet Size: 35"

Optional Accessories:

Cutting Board CB018
 Size: 16-3/4" x 12"
 x 1-1/8" List \$91



Bottom Grid G040
 Size: 17-1/2" x
 14-1/2" List \$100



Colander COL018
 Size: 16-3/4" x 9"
 x 4-3/4" List \$186



Drain Mat DM018
 Size: 16-1/2"
 x 12-3/16" x 5/16"
 List \$117



Strainer SD-01
 Size: 4-5/8" x
 3-1/2" List \$18



Strainer SD-33
 Size: 4-1/2" x
 3-15/16" List \$23



Strainer SD-39
 Size: 4-1/2" x
 4-3/64" List \$23



DSU3118 \$983.00

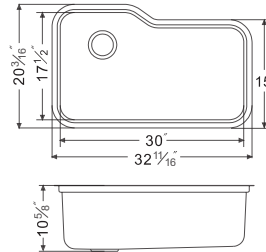

Single Bowl with Side Drain
 Material: 304 Stainless Steel
 Content: 18/10 Chrome-Nickel
 Gauge: 16
 Finish: Polished Satin
 Size: 32-11/16" x 20-3/16" x 10-5/8"
 Drain Opening: 3-1/2"
 Undercoating: Padded
 Cutout Template included
 Limited Lifetime Warranty
 Minimum Cabinet Size: 34-11/16"

Optional Accessories:

Cutting Board CB118
 Size: 18-1/4" x 13-3/4"
 x 1-1/8" List \$91



Bottom Grid G037
 Size: 28-3/8" x 16"
 List \$144

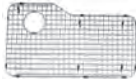

Colander COL118
 Size: 15-1/2" x 8-3/4"
 x 4-3/8" List \$174



Drain Mat DM118
 Size: 15-9/16"
 x 12-3/16" x 5/16"
 List \$140



Strainer SD-01
 Size: 4-5/8" x
 3-1/2" List \$18



Strainer SD-33
 Size: 4-1/2" x
 3-15/16" List \$23



Strainer SD-39
 Size: 4-1/2" x
 4-3/64" List \$23



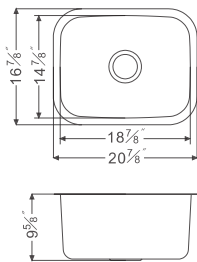

ASU103

\$290.00

Single Bowl Sink
 Material: 304 Stainless Steel
 Content: 18/10 Chrome-Nickel
 Gauge: 18
 Finish: Polished Satin
 Size: 20-7/8" x 16-7/8" x 9-5/8"
 Drain Opening: 3-1/2"
 Undercoating: Padded
 Cutout Template included
 Limited Lifetime Warranty
 Minimum Cabinet Size: 22-7/8"

Optional Accessories:

Bottom Grid G034

Size: 17-3/8" x 13-1/4"

List \$84



Strainer SD-01

Size: 4-5/8" x 3-1/2"

List \$18



Strainer SD-33

Size: 4-1/2" x 3-15/16"

List \$23



Drain Mat DM001

Size: 19-11/16" x 12" x 5/16"

List \$176

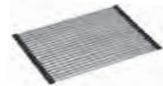

Strainer SD-39

Size: 4-1/2" x 4-3/64"

List \$23

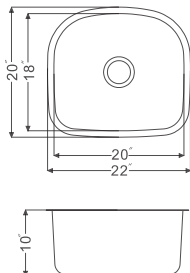

ASU105

\$364.00

Single Bowl Sink
 Material: 304 Stainless Steel
 Content: 18/10 Chrome-Nickel
 Gauge: 18
 Finish: Polished Satin
 Size: 22" x 20" x 10"
 Drain Opening: 3-1/2"
 Undercoating: Padded
 Cutout Template included
 Limited Lifetime Warranty
 Minimum Cabinet Size: 24"

Optional Accessories:

Bottom Grid G032

Size: 18-3/8" x 16-3/8"

List \$93



Strainer SD-01

Size: 4-5/8" x 3-1/2"

List \$18



Strainer SD-33

Size: 4-1/2" x 3-15/16"

List \$23



Drain Mat DM001

Size: 19-11/16" x 12" x 5/16"

List \$176

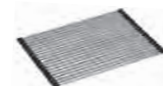

Strainer SD-39

Size: 4-1/2" x 4-3/64"

List \$23



Undermount ASU Sinks

Model No. List Price Description

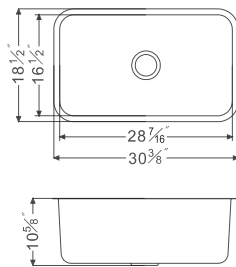
ASU106
\$532.00

Single Bowl Sink
 Material: 304 Stainless Steel
 Content: 18/10 Chrome-Nickel
 Gauge: 18
 Finish: Polished Satin
 Size: 30-3/8" x 18-1/2" x 10-5/8"
 Drain Opening: 3-1/2"
 Undercoating: Padded
 Cutout Template included
 Limited Lifetime Warranty
 Minimum Cabinet Size: 32-3/8"

Optional Accessories:
Cutting Board CB019

 Size: 18-3/8" x 11-3/4"
List \$87

Strainer SD-01

 Size: 4-5/8" x 3-1/2"
List \$18

Bottom Grid G033

 Size: 26-3/4" x 14-1/2"
List \$117

Strainer SD-33

 Size: 4-1/2" x 3-15/16"
List \$23

Drain Mat DM001

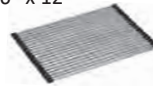
 Size: 19-11/16" x 12" x 5/16"
List \$176

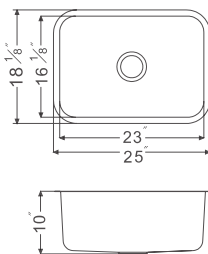
Strainer SD-39

 Size: 4-1/2" x 4-3/64"
List \$23

ASU2316
\$507.00

Single Bowl Sink
 Material: 304 Stainless Steel
 Content: 18/10 Chrome-Nickel
 Gauge: 18
 Finish: Polished Satin
 Size: 25" x 18-1/8" x 10"
 Drain Opening: 3-1/2"
 Undercoating: Padded
 Cutout Template included
 Limited Lifetime Warranty
 Minimum Cabinet Size: 27"

Optional Accessories:
Cutting Board CB019

 Size: 18-3/4" x 11-3/4"
List \$87

Strainer SD-01

 Size: 4-5/8" x 3-1/2"
List \$18

Bottom Grid G039

 Size: 21-1/4" x 14-1/2"
List \$105

Strainer SD-33

 Size: 4-1/2" x 3-15/16"
List \$23

Drain Mat DM001

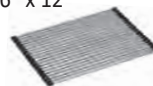
 Size: 19-11/16" x 12" x 5/16"
List \$176

Strainer SD-39

 Size: 4-1/2" x 4-3/64"
List \$23

Undermount Bar Sinks

Model No. List Price Description



BSF201710 \$583.00

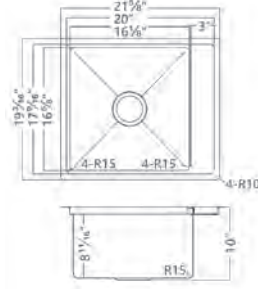

Bar Sink
 Material: 304 Stainless Steel
 Content: 18/10 Chrome-Nickel
 Gauge: 18
 Finish: Polished Satin
 Size: 21-5/8" x 19-3/16" x 10"
 Drain Opening: 3-1/2"
 Undercoating: Padded
 Cutout Template included
 Limited Lifetime Warranty
 Minimum Cabinet Size: 23-5/8"

Optional Accessories:

Utensil Shelf **T201710**
 Size: 16-1/2" x 2-1/2" x 1-5/8" **List \$88**



Premium Bottom Grid **G813**
 Size: 15-5/8" x 16-1/16" **List \$176**

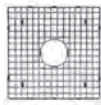

Basket **BK321710**
 Size: 16-1/2" x 8-11/16" x 6" **List \$78**



Drain Mat **DM710**
 Size: 17-5/16" x 12-3/16" x 5/16" **List \$128**

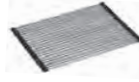

Strainer **SD-01**
 Size: 4-5/8" x 3-1/2" **List \$18**



Strainer **SD-33**
 Size: 4-1/2" x 3-15/16" **List \$23**



Strainer **SD-39**
 Size: 4-1/2" x 4-3/64" **List \$23**



BS121307-N \$183.00

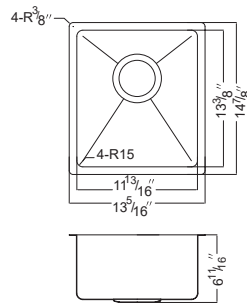

Bar Sink
 Material: 304 Stainless Steel
 Content: 18/10 Chrome-Nickel
 Gauge: 18
 Finish: Polished Satin
 Size: 13-5/16" x 14-7/8" x 6-11/16"
 Drain Opening: 3-1/2"
 Undercoating: Padded
 Cutout Template included
 Limited Lifetime Warranty
 Minimum Cabinet Size: 15-5/16"

Optional Accessories:

Bottom Grid **G081**
 Size: 10-3/8" x 11-3/4" **List \$64**

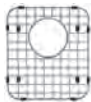

Drain Mat **DM001**
 Size: 19-11/16" x 12" x 5/16" **List \$176**

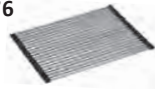

Strainer **SD-01**
 Size: 4-5/8" x 3-1/2" **List \$18**



Strainer **SD-33**
 Size: 4-1/2" x 3-15/16" **List \$23**



Strainer **SD-39**
 Size: 4-1/2" x 4-3/64" **List \$23**



BS131507-N \$218.00

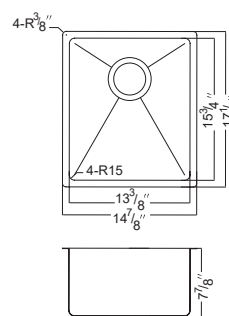

Bar Sink
 Material: 304 Stainless Steel
 Content: 18/10 Chrome-Nickel
 Gauge: 18
 Finish: Polished Satin
 Size: 14-7/8" x 17-1/4" x 7-7/8"
 Drain Opening: 3-1/2"
 Undercoating: Padded
 Cutout Template included
 Limited Lifetime Warranty
 Minimum Cabinet Size: 16-7/8"

Optional Accessories:

Bottom Grid **G082**
 Size: 12-7/8" x 15-1/4" **List \$76**



Drain Mat **DM001**
 Size: 19-11/16" x 12" x 5/16" **List \$176**

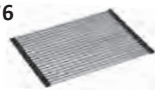

Strainer **SD-01**
 Size: 4-5/8" x 3-1/2" **List \$18**



Strainer **SD-33**
 Size: 4-1/2" x 3-15/16" **List \$23**



Strainer **SD-39**
 Size: 4-1/2" x 4-3/64" **List \$23**



Undermount Bar Sinks Model No. List Price Description



BS161609-N \$255.00

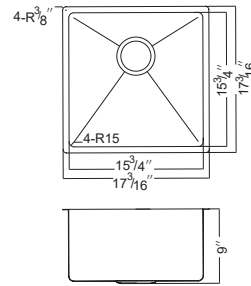

Bar Sink
 Material: 304 Stainless Steel
 Content: 18/10 Chrome-Nickel
 Gauge: 18
 Finish: Polished Satin
 Size: 17-3/16" x 17-3/16" x 9"
 Drain Opening: 3-1/2"
 Undercoating: Padded
 Cutout Template included
 Limited Lifetime Warranty
 Minimum Cabinet Size: 19-3/16"

Optional Accessories:

Bottom Grid **G083**
 Size: 15-1/4" x 15-1/4"
List \$82



Drain Mat **DM001**
 Size: 19-11/16" x 12" x 5/16"
List \$176

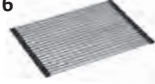

Strainer **SD-01**
 Size: 4-5/8" x 3-1/2"
List \$18



Strainer **SD-33**
 Size: 4-1/2" x 3-15/16"
List \$23



Strainer **SD-39**
 Size: 4-1/2" x 4-3/64"
List \$23



BSQ121508 \$459.00

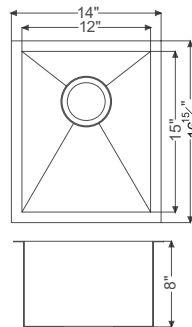

Square Bar Sink
 Material: 304 Stainless Steel
 Content: 18/10 Chrome-Nickel
 Gauge: 18
 Finish: Polished Satin
 Size: 14" x 16-15/16" x 8"
 Drain Opening: 3-1/2"
 Undercoating: Padded
 Cutout Template included
 Limited Lifetime Warranty
 Minimum Cabinet Size: 16"

Optional Accessories:

Drain Mat **DM001**
 Size: 19-11/16" x 12" x 5/16"
List \$176

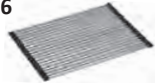

Strainer **SD-01**
 Size: 4-5/8" x 3-1/2"
List \$18



Strainer **SD-33**
 Size: 4-1/2" x 3-15/16"
List \$23



Strainer **SD-39**
 Size: 4-1/2" x 4-3/64"
List \$23



BSQ131610 \$498.00

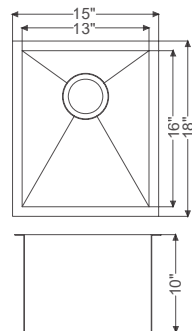

Square Bar Sink
 Material: 304 Stainless Steel
 Content: 18/10 Chrome-Nickel
 Gauge: 18
 Finish: Polished Satin
 Size: 15" x 18" x 10"
 Drain Opening: 3-1/2"
 Undercoating: Padded
 Cutout Template included
 Limited Lifetime Warranty
 Minimum Cabinet Size: 17"

Optional Accessories:

Drain Mat **DM001**
 Size: 19-11/16" x 12" x 5/16"
List \$176

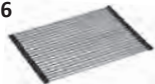

Strainer **SD-01**
 Size: 4-5/8" x 3-1/2"
List \$18



Strainer **SD-33**
 Size: 4-1/2" x 3-15/16"
List \$23



Strainer **SD-39**
 Size: 4-1/2" x 4-3/64"
List \$23



Undermount Bar Sinks **Model No.** **List Price** **Description**

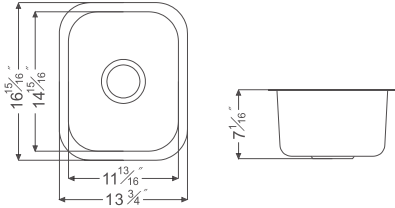

BS1215 **\$183.00**

Bar Sink
 Material: 304 Stainless Steel
 Content: 18/10 Chrome-Nickel
 Gauge: 18
 Finish: Polished Satin
 Size: 13-3/4" x 16-15/16" x 7-1/16"
 Drain Opening: 3-1/2"
 Undercoating: Padded
 Cutout Template included
 Limited Lifetime Warranty
 Minimum Cabinet Size: 15-3/4"

Optional Accessories:

Bottom Grid **G035**
 Size: 13-7/8" x 10-5/8" **List \$75**



Strainer **SD-33**
 Size: 4-1/2" x 3-15/16" **List \$23**



Strainer **SD-01**
 Size: 4-5/8" x 3-1/2" **List \$18**



Strainer **SD-39**
 Size: 4-1/2" x 4-3/64" **List \$23**

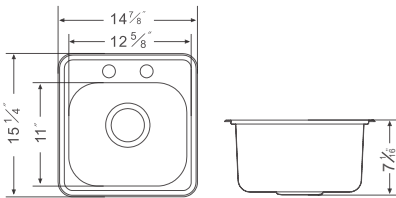

BST1515 **\$159.00**

Bar Sink
 Material: 304 Stainless Steel
 Content: 18/10 Chrome-Nickel
 Gauge: 20
 Finish: Polished Satin
 Size: 14-7/8" x 15-1/4" x 7-1/16"
 Drain Opening: 3-1/2"
 Undercoating: Padded
 Limited Lifetime Warranty
 Minimum Cabinet Size: 16-7/8"

Optional Accessories:

Strainer **SD-01**
 Size: 4-5/8" x 3-1/2" **List \$18**



Strainer **SD-33**
 Size: 4-1/2" x 3-15/16" **List \$23**



Strainer **SD-39**
 Size: 4-1/2" x 4-3/64" **List \$23**



NEW

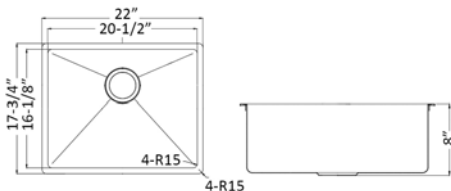

3233H **\$216.00**

Bar Sink
 Material: 304 Stainless Steel
 Content: 18/10 Chrome-Nickel
 Gauge: 18
 Finish: Polished Satin
 Size: 22" x 17-3/4" x 8"
 Drain Opening: 3-1/2"
 Undercoating: Padded
 Limited Lifetime Warranty
 Minimum Cabinet Size: 24"

Optional Accessories:

Drain Mat **DM001** **List \$176**
 Size: 19-11/16" x 12" x 5/16"

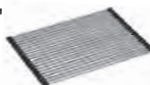

Strainer **SD-33**
 Size: 4-1/2" x 3-15/16" **List \$23**



Strainer **SD-01**
 Size: 4-5/8" x 3-1/2" **List \$18**



Strainer **SD-39**
 Size: 4-1/2" x 4-3/64" **List \$23**



Top Mount Bar Sinks Model No. List Price Description



3235 **\$207.00**

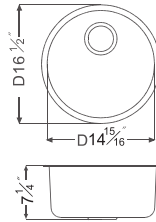

Round Bar Sink
 Material: 304 Stainless Steel
 Content: 18/10 Chrome-Nickel
 Gauge: 20
 Finish: Polished Satin
 Size: 16-1/2" x 7-1/4"
 Drain Opening: 3-1/2"
 Undercoating: Padded
 Limited Lifetime Warranty
 Minimum Cabinet Size: 18-1/2"

Optional Accessories:

Cutter Board **CB016**
 Size: 15-11/16" x 14"
 x 13/16"
 List: \$86



Drain Mat **DM001**
 Size: 19-11/16" x 12" x 5/16"
 List \$176

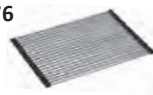

Strainer **SD-01**
 Size: 4-5/8" x
 3-1/2"
 List \$18



Strainer **SD-33**
 Size: 4-1/2" x
 3-15/16"
 List \$23



Strainer **SD-39**
 Size: 4-1/2" x
 4-3/64"
 List \$23



3237 **\$109.00**

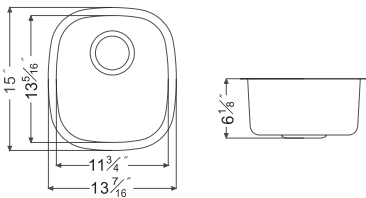

Bar Sink
 Material: 304 Stainless Steel
 Content: 18/10 Chrome-Nickel
 Gauge: 22
 Finish: Polished Satin
 Size: 13-7/16" x 15" x 6-1/8"
 Drain Opening: 3-1/2"
 Undercoating: Padded
 Cutout Template included
 Limited Lifetime Warranty
 Minimum Cabinet Size: 15-7/16"

Optional Accessory:

Strainer **SD-01**
 Size: 4-5/8" x 3-1/2"
 List \$18



Strainer **SD-33**
 Size: 4-1/2" x 3-15/16"
 List \$23



Strainer **SD-39**
 Size: 4-1/2" x 4-3/64"
 List \$23



3238 **\$194.00**

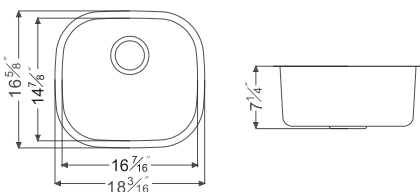

Bar Sink
 Material: 304 Stainless Steel
 Content: 18/10 Chrome-Nickel
 Gauge: 20
 Finish: Polished Satin
 Size: 18-3/16" x 16-5/8" x 7-1/4"
 Drain Opening: 3-1/2"
 Undercoating: Padded
 Cutout Template included
 Limited Lifetime Warranty
 Minimum Cabinet Size: 20-3/16"

Optional Accessories:

Drain Mat **DM001** List \$176
 Size: 19-11/16"
 x 12" x 5/16"

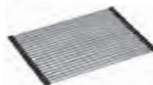

Strainer **SD-33**
 Size: 4-1/2" x 3-15/16"
 List \$23



Strainer **SD-01**
 Size: 4-5/8" x 3-1/2"
 List \$18



Strainer **SD-39**
 Size: 4-1/2" x 4-3/64"
 List \$23



Introducing the Americans with Disabilities Act Sinks. Thoughtful and practical designs to fulfill people with special needs while focusing on quality and durability.

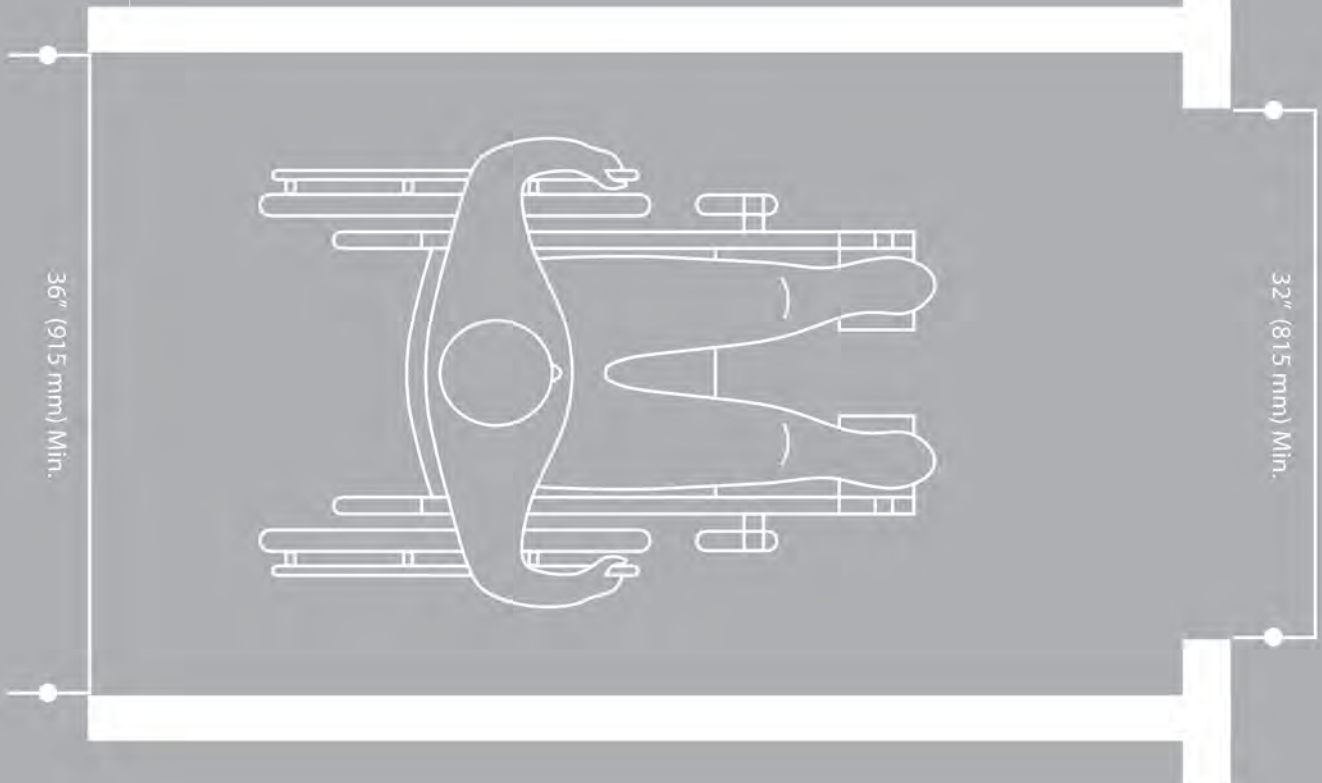

ADA Undermount Sinks	Model No.	List Price	Description
	ADAUS241607	\$331.00	<p>Square Single Bowl Sink Material: 304 Stainless Steel Content: 18/10 Chrome-Nickel Gauge: 18 Finish: Polished Satin Size: 26" x 18" x 6-5/8" Drain Opening: 3-1/2" Undercoating: Padded Cutout Template included Limited Lifetime Warranty Minimum Cabinet Size: 28"</p>
	<p>Optional Accessories:</p> <p>Premium Bottom Grid G062 Size: 23-9/16" x 15-9/16" List \$237</p> <p>Drain Mat DM001 Size: 19-11/16" x 12" x 5/16" List \$176</p>	<p>Strainer SD-01 Size: 4-5/8" x 3-1/2" List \$18</p> <p>Strainer SD-33 Size: 4-1/2" x 3-15/16" List \$23</p> <p>Strainer SD-39 Size: 4-1/2" x 4-3/64" List \$23</p>	

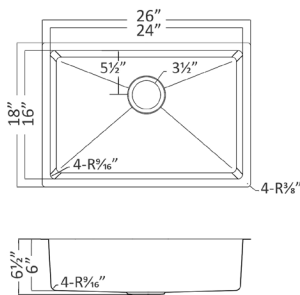

ADAUS240700 \$331.00

Single Bowl Sink
 Material: 304 Stainless Steel
 Content: 18/8 Chrome-Nickel
 Gauge: 18
 Finish: Polished Satin
 Size: 26" x 18" x 6-7/8"
 Drain Opening: 3-1/2"
 Undercoating: Padded
 Cutout Template included
 Limited Lifetime Warranty
 Minimum Cabinet Size: 28"

Optional Accessories:

Drain Mat **DM001**
 Size: 19-11/16" x 12" x 5/16"
List \$176

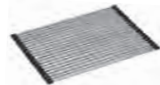

Strainer **SD-01**
 Size: 4-5/8" x 3-1/2"
List \$18



Strainer **SD-33**
 Size: 4-1/2" x 3-15/16"
List \$23



Strainer **SD-39**
 Size: 4-1/2" x 4-3/64"
List \$23

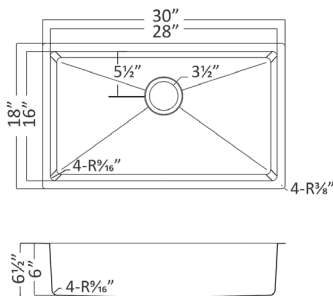

ADAUS280700 \$397.00

Single Bowl Sink
 Material: 304 Stainless Steel
 Content: 18/8 Chrome-Nickel
 Gauge: 18
 Finish: Polished Satin
 Size: 30" x 18" x 6-7/8"
 Drain Opening: 3-1/2"
 Undercoating: Padded
 Cutout Template included
 Limited Lifetime Warranty
 Minimum Cabinet Size: 32"

Optional Accessories:

Drain Mat **DM001**
 Size: 19-11/16" x 12" x 5/16"
List \$176

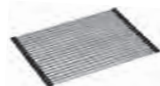

Strainer **SD-01**
 Size: 4-5/8" x 3-1/2"
List \$18



Strainer **SD-33**
 Size: 4-1/2" x 3-15/16"
List \$23



Strainer **SD-39**
 Size: 4-1/2" x 4-3/64"
List \$23



ADA Undermount Sinks Model No. List Price Description

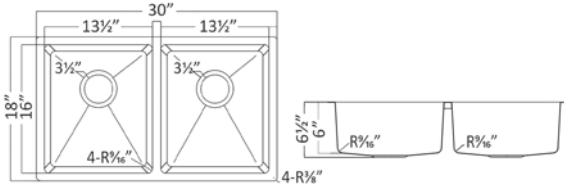

ADAUS300707 **\$441.00** Equal Double Bowl Sink
 Material: 304 Stainless Steel
 Content: 18/8 Chrome-Nickel
 Gauge: 18
 Finish: Polished Satin
 Size: 30" x 18" x 6-7/8"
 Drain Opening: 3-1/2"
 Undercoating: Padded
 Cutout Template included
 Limited Lifetime Warranty
 Minimum Cabinet Size: 32"

Optional Accessories:

Drain Mat **DM001**
 Size: 19-11/16" x 12" x 5/16"
List \$176

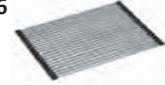

Strainer **SD-01**
 Size: 4-5/8" x 3-1/2"
List \$18



Strainer **SD-33**
 Size: 4-1/2" x 3-15/16"
List \$23



Strainer **SD-39**
 Size: 4-1/2" x 4-3/64"
List \$23



ADA Top Mount Sink Model No. List Price Description

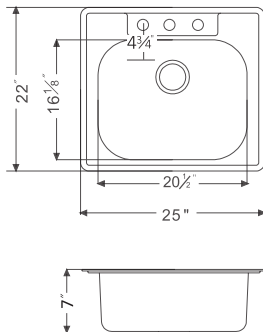

ADAT250700 **\$198.00** Single Bowl Sink
 Material: 304 Stainless Steel
 Content: 18/8 Chrome-Nickel
 Gauge: 20
 Finish: Polished Satin
 Size: 25" x 22" x 7"
 Drain Opening: 3-1/2"
 Undercoating: Padded
 Limited Lifetime Warranty
 Minimum Cabinet Size: 27"

Optional Accessories:

Drain Mat **DM001**
 Size: 19-11/16" x 12" x 5/16"
List \$176

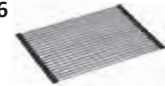

Strainer **SD-01**
 Size: 4-5/8" x 3-1/2"
List \$18



Strainer **SD-33**
 Size: 4-1/2" x 3-15/16"
List \$23



Strainer **SD-39**
 Size: 4-1/2" x 4-3/64"
List \$23



ADA Top Mount Sink Model No. List Price Description



NEW

ADAT250700H \$210.00

Single Bowl Sink
 Material: 304 Stainless Steel
 Content: 18/8 Chrome-Nickel
 Gauge: 18
 Finish: Polished Satin
 Size: 25" x 22" x 7"
 Drain Opening: 3-1/2"
 Undercoating: Padded
 Limited Lifetime Warranty
 Minimum Cabinet Size: 27"

Optional Accessories:

Drain Mat **DM001**
 Size: 19-11/16" x 12" x 5/16"
List \$176

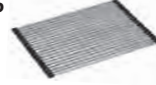

Strainer **SD-01**
 Size: 4-5/8" x 3-1/2"
List \$18



Strainer **SD-33**
 Size: 4-1/2" x 3-15/16"
List \$23



Strainer **SD-39**
 Size: 4-1/2" x 4-3/64"
List \$23

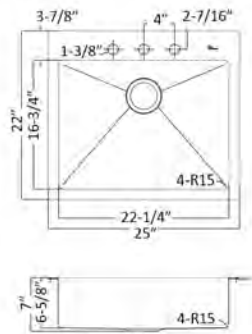

NEW

ADAT280700H \$230.00

Single Bowl Sink
 Material: 304 Stainless Steel
 Content: 18/8 Chrome-Nickel
 Gauge: 18
 Finish: Polished Satin
 Size: 28" x 22" x 7"
 Drain Opening: 3-1/2"
 Undercoating: Padded
 Limited Lifetime Warranty
 Minimum Cabinet Size: 30"

Optional Accessories:

Drain Mat **DM001**
 Size: 19-11/16" x 12" x 5/16"
List \$176

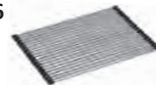

Strainer **SD-01**
 Size: 4-5/8" x 3-1/2"
List \$18



Strainer **SD-33**
 Size: 4-1/2" x 3-15/16"
List \$23



Strainer **SD-39**
 Size: 4-1/2" x 4-3/64"
List \$23

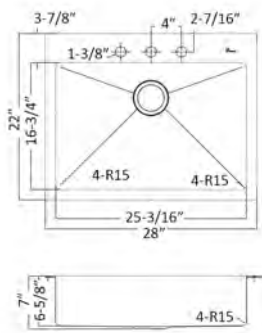

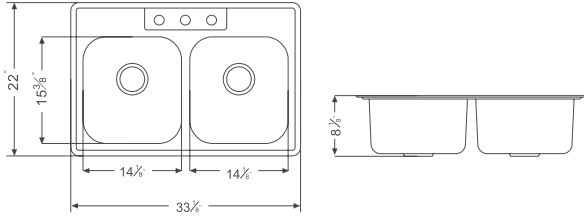

AST102

\$303.00

Equal Double Bowl Sink
Material: 304 Stainless Steel
Content: 18/10 Chrome-Nickel
Gauge: 20
Finish: Polished Satin
Size: 33-1/8" x 22" x 8-1/8"
Drain Opening: 3-1/2"
Undercoating: Padded
Limited Lifetime Warranty
Minimum Cabinet Size: 35-1/8"

Optional Accessories:

Drain Mat **DM001** List **\$176**
Size: 19-11/16"
x 12" x 5/16"

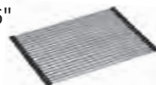

Strainer **SD-33**
Size: 4-1/2" x 3-15/16"
List **\$23**



Strainer **SD-01**
Size: 4-5/8" x 3-1/2"
List **\$18**



Strainer **SD-39**
Size: 4-1/2" x 4-3/64"
List **\$23**

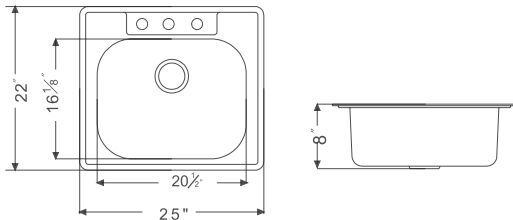

AST103

\$252.00

Single Bowl Sink
Material: 304 Stainless Steel
Content: 18/10 Chrome-Nickel
Gauge: 20
Finish: Polished Satin
Size: 25" x 22" x 8"
Drain Opening: 3-1/2"
Undercoating: Padded
Limited Lifetime Warranty
Minimum Cabinet Size: 27"

Optional Accessories:

Drain Mat **DM001** List **\$176**
Size: 19-11/16"
x 12" x 5/16"

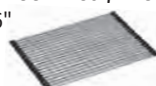

Strainer **SD-33**
Size: 4-1/2" x 3-15/16"
List **\$23**



Strainer **SD-01**
Size: 4-5/8" x 3-1/2"
List **\$18**



Strainer **SD-39**
Size: 4-1/2" x 4-3/64"
List **\$23**

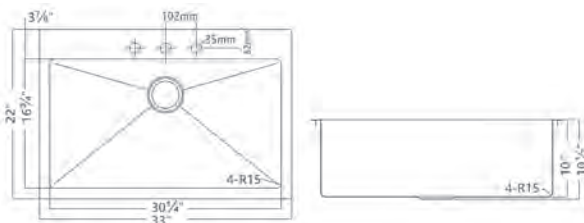

AST104

\$468.00

Single Bowl Sink
Material: 304 Stainless Steel
Content: 18/8 Chrome-Nickel
Gauge: 18
Finish: Polished Satin
Size: 33" x 22" x 10-1/2"
Drain Opening: 3-1/2"
Undercoating: Padded
Limited Lifetime Warranty
Minimum Cabinet Size: 35"

Optional Accessories:

Drain Mat **DM001** List **\$176**
Size: 19-11/16"
x 12" x 5/16"



Strainer **SD-33**
Size: 4-1/2" x 3-15/16"
List **\$23**









Strainer **SD-01**
Size: 4-5/8" x 3-1/2"
List **\$18**

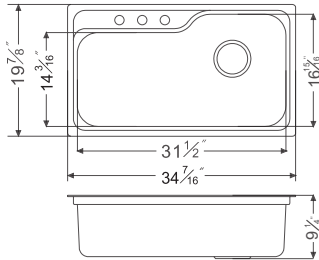
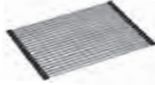

Strainer **SD-39**
Size: 4-1/2" x 4-3/64"
List **\$23**

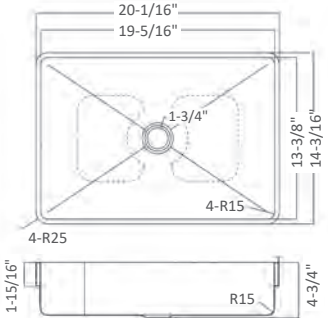

Top Mount CH Sinks	Model No.	List Price	Description
 	CH368	\$492.00	Single Bowl Sink Material: 304 Stainless Steel Content: 18/10 Chrome-Nickel Gauge: 20 Finish: Polished Satin Size: 34-7/16" x 19-7/8" x 9-1/4" Drain Opening: 3-1/2" Undercoating: Padded Limited Lifetime Warranty Minimum Cabinet Size: 36-7/16"
Optional Accessories:			
Drain Mat DM001 Size: 19-11/16" x 12" x 5/16" List \$176 	Strainer SD-01 Size: 4-5/8" x 3-1/2" List \$18 		
	Strainer SD-33 Size: 4-1/2" x 3-15/16" List \$23 		
	Strainer SD-39 Size: 4-1/2" x 4-3/64" List \$23 		

Bathroom Vanity Stainless Steel Sink	Model No.	List Price	Description
 	WBT5136RG	\$522.00	Vanity Sink Top Material: Stainless Steel Content: 18/8 Chrome-Nickel Gauge: 18 Finish: Rose Gold Size: 20-1/16" x 14-3/16" x 4-3/4" Drain Opening: 1-3/4" Limited Lifetime Warranty Minimum Cabinet Size: 22-1/16"
Optional Accessory:			
Standard Pop-Up Drain POP213 Rose Gold List \$74			

Bathroom Vanity Stainless Steel Sink

Model No.

List Price

Description

NEW

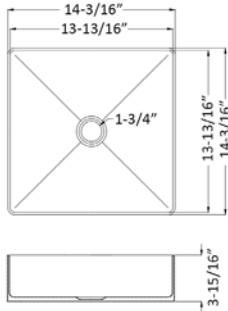

WBT3636MAG

\$245.00

Vanity Sink Top
 Material: Stainless Steel
 Content: 18/8 Chrome-Nickel
 Gauge: 18
 Finish: Gold
 Size: 14-3/16" x 14-3/16" x 3-15/16"
 Drain Opening: 1-3/4"
 Limited Lifetime Warranty
 Minimum Cabinet Size: 16-3/16"

Optional Accessories: _____

Standard Pop-Up Drain
 Gold

POP218 List \$74



Standard Pop-Up Drain
 Nanometer Black Grey

POP217 List \$74

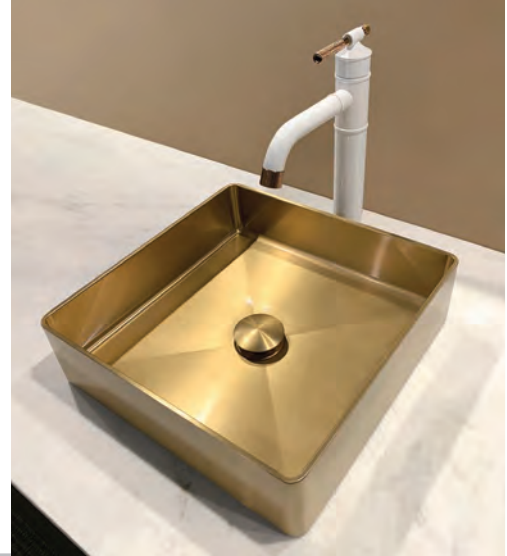

NEW

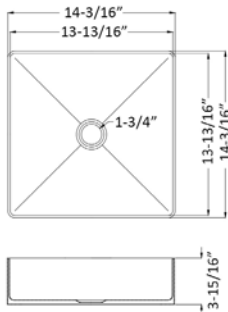
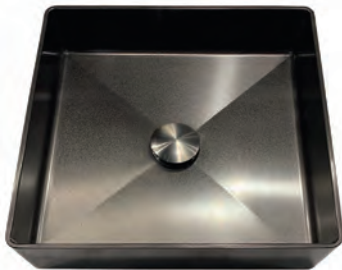

WBT3636NMBS

\$245.00

Vanity Sink Top
 Material: Stainless Steel
 Content: 18/8 Chrome-Nickel
 Gauge: 18
 Finish: Nanometer Black Grey (Sand)
 Size: 14-3/16" x 14-3/16" x 3-15/16"
 Drain Opening: 1-3/4"
 Limited Lifetime Warranty
 Minimum Cabinet Size: 16-3/16"

Optional Accessories: _____

Standard Pop-Up Drain
 Nanometer Black Grey

POP217 List \$74



Standard Pop-Up Drain
 Gold

POP218 List \$74



Bathroom Vanity Stainless Steel Sink **Model No.** **List Price** **Description**

NEW

WBT3636NMBG \$245.00

Vanity Sink Top
 Material: Stainless Steel
 Content: 18/8 Chrome-Nickel
 Gauge: 18
 Finish: Nanometer Black Grey
 Size: 14-3/16" x 14-3/16" x 3-15/16"
 Drain Opening: 1-3/4"
 Limited Lifetime Warranty
 Minimum Cabinet Size: 16-3/16"

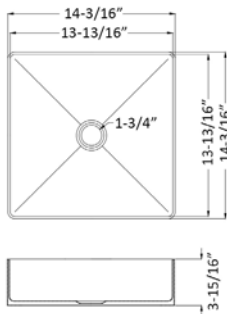

Optional Accessories:
 Standard Pop-Up Drain
 Nanometer Black Grey
POP217 List \$74



Standard Pop-Up Drain
 Gold
POP218 List \$74



NEW

WBTL4040NMBG \$680.00

Pedestal Sink
 Material: Stainless Steel
 Content: 18/8 Chrome-Nickel
 Gauge: 18
 Finish: Nanometer Black Grey
 Size: 15-5/8" x 15-5/8" x 32-11/16"
 Drain Opening: 1-3/4"
 Limited Lifetime Warranty

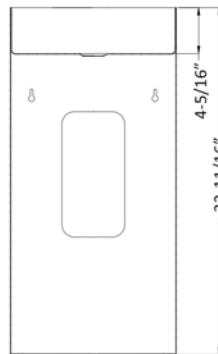
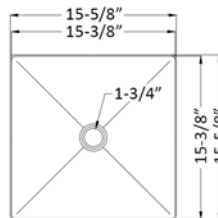

Optional Accessories:
 Standard Pop-Up Drain
 Nanometer Black Grey
POP217 List \$74



Standard Pop-Up Drain
 Gold
POP218 List \$74



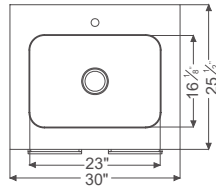
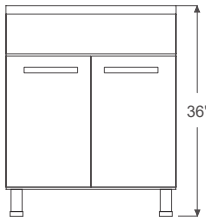

SSC3036 **\$2,922.00**

Seamless One Piece Cabinet with Integrated Sink ASU2316
 Material: 304 Stainless Steel
 Sink: 18G; Cabinet Body: 20G
 Finish: Polished Satin
 Sink Undercoating: Padded
 Size: 30" x 25-1/2" x 36"
 Drain Opening: 3-1/2"
 Limited Lifetime Warranty

Included Accessory:

Garbage Can **GC036**
 Size: 17-13/16" x 9-13/16"
 x 14-3/8"
List \$151



Optional Accessories:

Bottom Grid **G039**
 Size: 21-1/4" x 14-1/2"
List \$105

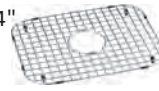

Cutting Board **CB019**
 Size: 18-3/8" x 11-3/4" x 1-1/8"
List \$87



Under Sink Tray **BT0282201**
 Size: 28" x 22" x 1"
List \$154



Drain Mat **DM001**
 Size: 19-11/16" x 12" x 5/16"
List \$176

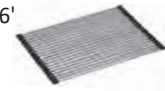

Strainer **SD-01**
 Size: 4-5/8" x 3-1/2"
List \$18



Strainer **SD-33**
 Size: 4-1/2" x 3-15/16"
List \$23

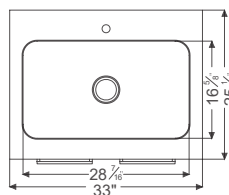
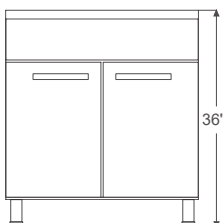

SSC3336 **\$3,098.00**

Seamless One Piece Cabinet with Integrated Sink ASU106
 Material: 304 Stainless Steel
 Sink: 18G; Cabinet Body: 20G
 Finish: Polished Satin
 Sink Undercoating: Padded
 Size: 33" x 25-1/2" x 36"
 Drain Opening: 3-1/2"
 Limited Lifetime Warranty

Included Accessories:

Garbage Can **GC036**
 Size: 17-13/16" x 9-13/16"
 x 14-3/8"
List \$151



Cutting Board **CB019**
 Size: 18-3/8" x 11-3/4" x 1-1/8"
List \$87



Optional Accessories:

Bottom Grid **G033**
 Size: 26-3/4" x 14-1/2"
List \$117



Drain Mat **DM001**
 Size: 19-11/16" x 12" x 5/16"
List \$176

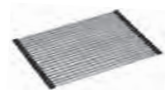

Under Sink Tray **BT0312201**
 Size: 31" x 22" x 1"
List \$166



Strainer **SD-01**
 Size: 4-5/8" x 3-1/2"
List \$18



Strainer **SD-33**
 Size: 4-1/2" x 3-15/16"
List \$23



Stainless Steel Sink Base Cabinets

Model No. List Price Description

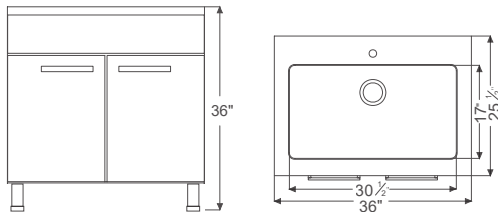

SSC3636 \$3,281.00 Seamless One Piece Cabinet with Integrated Sink DSU3017
 Material: 304 Stainless Steel
 Sink: 16G; Cabinet Body: 20G
 Finish: Polished Satin
 Sink Undercoating: Padded
 Size: 36" x 25-1/2" x 36"
 Drain Opening: 3-1/2"
 Limited Lifetime Warranty

Included Accessories:

Garbage Can GC036
 Size: 17-13/16" x 9-13/16" x 14-3/8"
List \$151



Cutting Board CB017
 Size: 18-3/8" x 11-3/4" x 1-1/8"
List \$87

Optional Accessories:

Bottom Grid G031
 Size: 28-5/8" x 15-1/4"
List \$122

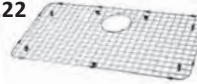

Drain Mat DM001
 Size: 19-11/16" x 12" x 5/16"
List \$176

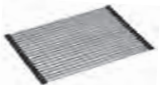

Strainer SD-01
 Size: 4-5/8" x 3-1/2"
List \$18



Under Sink Tray BT0342201
 Size: 34" x 22" x 1"
List \$176





Strainer SD-33
 Size: 4-1/2" x 3-15/16"
List \$23

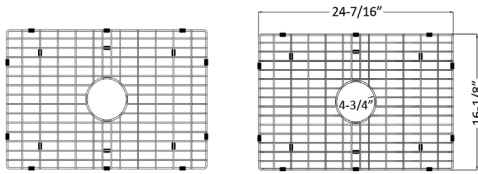
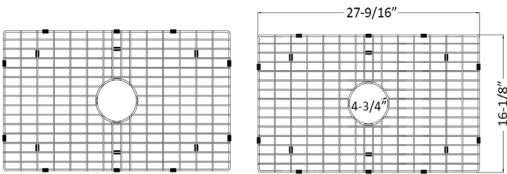

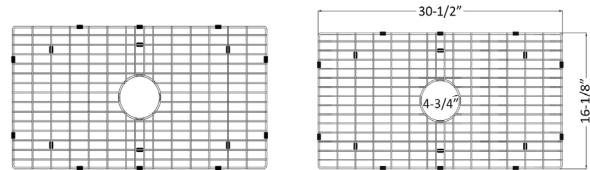
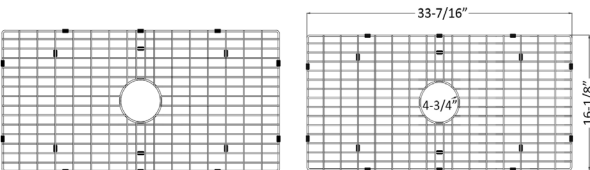

Bottom Grids	Model No.	List Price	Description
<p style="text-align: right;">NEW</p> 	DRG2517	\$57.00	<p>Sink Bottom Grid For use with sinks: DSRF2520, DSR2517 Material: 304 Stainless Steel Finish: Polished Satin One-Year Limited Warranty</p>
<p style="text-align: right;">NEW</p> 	DRG2817	\$62.00	<p>Sink Bottom Grid For use with sinks: DSRF2820, DSR2817 Material: 304 Stainless Steel Finish: Polished Satin One-Year Limited Warranty</p>

Complement your Dawn sink with accessories to maximize productivity and performance in the sink area.

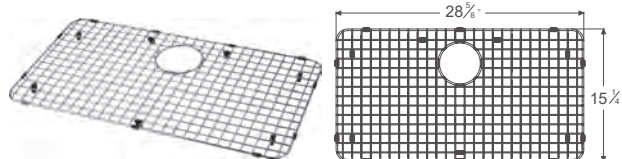
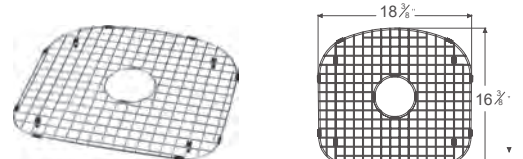

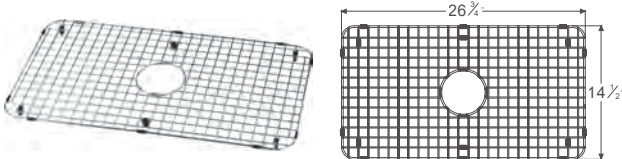
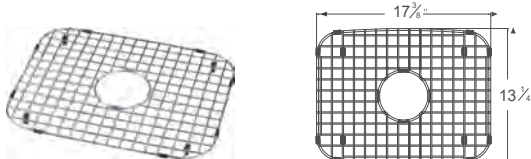
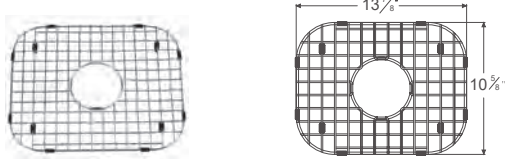
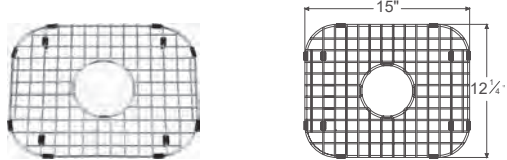
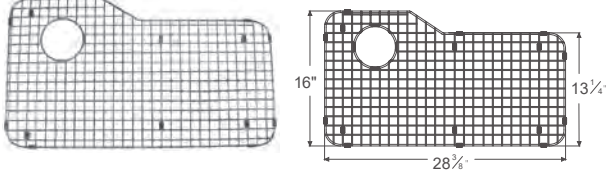
Bottom Grids	Model No.	List Price	Description
<p style="text-align: right; color: #00AEEF; font-weight: bold;">NEW</p> 	DRG3117	\$66.00	Sink Bottom Grid For use with sinks: DSRF3120, DSR3117 Material: 304 Stainless Steel Finish: Polished Satin One-Year Limited Warranty
<p style="text-align: right; color: #00AEEF; font-weight: bold;">NEW</p> 	DRG3417	\$70.00	Sink Bottom Grid For use with sinks: DSRF3420, DSR3417 Material: 304 Stainless Steel Finish: Polished Satin One-Year Limited Warranty
	G030	\$91.00	Sink Bottom Grid Material: 304 Stainless Steel Finish: Polished Satin One-Year Limited Warranty
	G031	\$122.00	Sink Bottom Grid For use with sinks: DAF3320, DAF3320C, DSU3017 For use with cabinet: SSC3636G Material: 304 Stainless Steel Finish: Polished Satin One-Year Limited Warranty
	G032	\$93.00	Sink Bottom Grid For use with sink: ASU105 Material: 304 Stainless Steel Finish: Polished Satin One-Year Limited Warranty

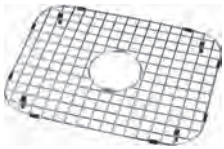
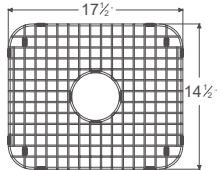
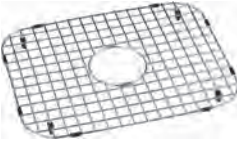
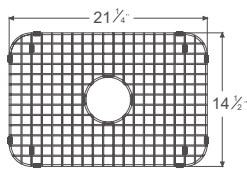
Bottom Grids	Model No.	List Price	Description
	G033	\$117.00	Sink Bottom Grid For use with sink: ASU106 For use with cabinet: SSC3336G Material: 304 Stainless Steel Finish: Polished Satin One-Year Limited Warranty
	G034	\$84.00	Sink Bottom Grid For use with sink: ASU103 Material: 304 Stainless Steel Finish: Polished Satin One-Year Limited Warranty
	G035	\$75.00	Sink Bottom Grid For use with sink: BS1215 Material: 304 Stainless Steel Finish: Polished Satin One-Year Limited Warranty
	G036	\$80.00	Sink Bottom Grid Material: 304 Stainless Steel Finish: Polished Satin One-Year Limited Warranty
	G037	\$144.00	Sink Bottom Grid For use with sink: DSU3118 Material: 304 Stainless Steel Finish: Polished Satin One-Year Limited Warranty

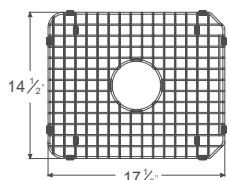
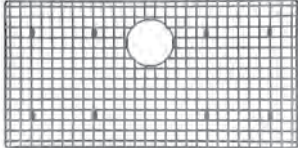
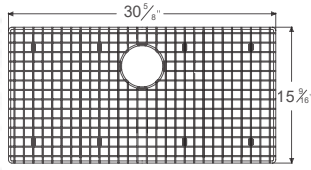
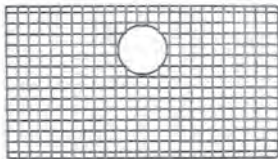
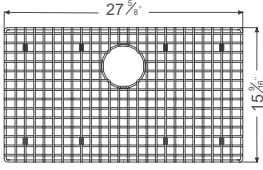
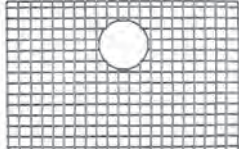
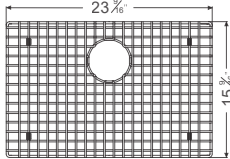
Bottom Grids		Model No.	List Price	Description
 	G038	\$100.00	Sink Bottom Grid For use with sink: DSU1916 Material: 304 Stainless Steel Finish: Polished Satin One-Year Limited Warranty	
 	G039	\$105.00	Sink Bottom Grid For use with sink: ASU2316, For use with cabinet: SSC3036G Material: 304 Stainless Steel Finish: Polished Satin One-Year Limited Warranty	
 	G040	\$100.00	Sink Bottom Grid For use with sink: DSU3018 Material: 304 Stainless Steel Finish: Polished Satin One-Year Limited Warranty	
 	G060	\$309.00	Premium Sink Bottom Grid For use with sinks: DSQ3116, XSR311610 Material: 304 Stainless Steel Finish: Polished Satin One-Year Limited Warranty	
 	G061	\$260.00	Premium Sink Bottom Grid For use with sinks: DSQ2816, XSR281610 Material: 304 Stainless Steel Finish: Polished Satin One-Year Limited Warranty	
 	G062	\$237.00	Premium Sink Bottom Grid For use with sinks: ADAUS241607, DSQ241607 and DSQ241609 Material: 304 Stainless Steel Finish: Polished Satin One-Year Limited Warranty	

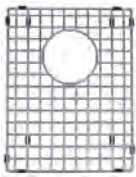
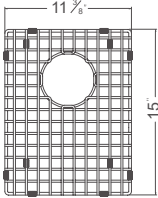
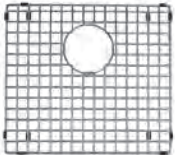
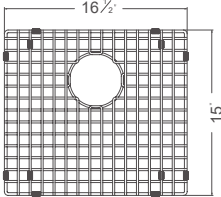
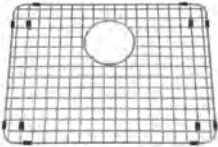
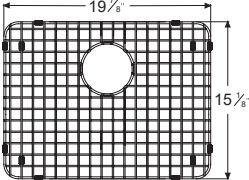
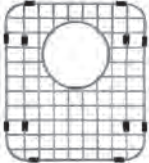
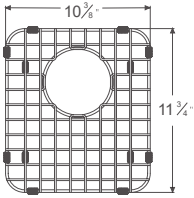
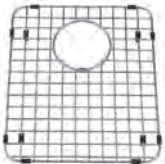
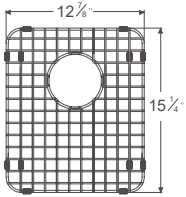
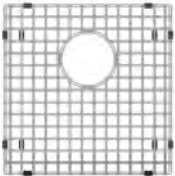
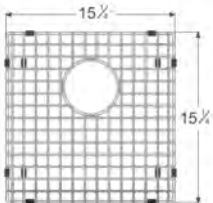
Bottom Grids		Model No.	List Price	Description
		G063	\$104.00	Sink Bottom Grid For use with sinks: DAF3321L (small bowl), DSQ301515 (small bowl) Material: 304 Stainless Steel Finish: Polished Satin One-Year Limited Warranty
		G064	\$134.00	Sink Bottom Grid For use with sinks: DAF3321L (large bowl), DSQ301515 (large bowl) Material: 304 Stainless Steel Finish: Polished Satin One-Year Limited Warranty
		G080	\$100.00	Sink Bottom Grid For use with sinks: SRU201609, XSR201609 Material: 304 Stainless Steel Finish: Polished Satin One-Year Limited Warranty
		G081	\$64.00	Sink Bottom Grid For use with sink: BS121307-N Material: 304 Stainless Steel Finish: Polished Satin One-Year Limited Warranty
		G082	\$76.00	Sink Bottom Grid For use with sinks: BS131507, SRU301616L/R-N (Small Bowl), Material: 304 Stainless Steel Finish: Polished Satin One-Year Limited Warranty
		G083	\$82.00	Sink Bottom Grid For use with sinks: BS161609-N, SRU301616L/R-N (Large Bowl), SRU331616-N, XSR321616 Material: 304 Stainless Steel Finish: Polished Satin One-Year Limited Warranty

Bottom Grids		Model No.	List Price	Description
		G517	\$114.00	Sink Bottom Grid For use with sink: DSU2517 Material: 304 Stainless Steel Finish: Polished Satin One-Year Limited Warranty
		G610	\$110.00	Sink Bottom Grid For use with sinks: SRU251610-N, XSR251610 Material: 304 Stainless Steel Finish: Polished Satin One-Year Limited Warranty
	NEW	G711	\$150.00	Sink Bottom Grid For use with sinks: DAF241610, SRU241610-N Material: 304 Stainless Steel Finish: Polished Satin One-Year Limited Warranty
	NEW	G712	\$105.00	Sink Bottom Grid For use with sink: SRU271610-N Material: 304 Stainless Steel Finish: Polished Satin One-Year Limited Warranty
	NEW	G713	\$100.00	Sink Bottom Grid For use with sink: SRU241610-N Material: 304 Stainless Steel Finish: Polished Satin One-Year Limited Warranty

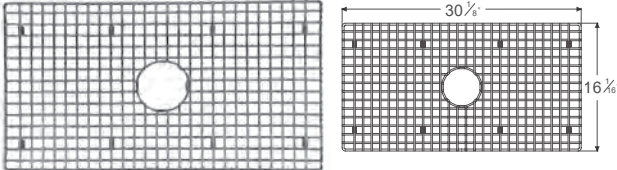
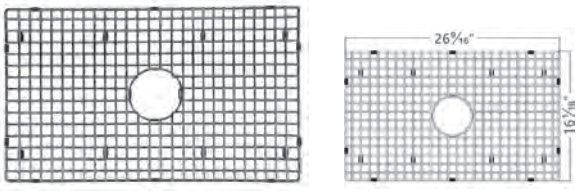
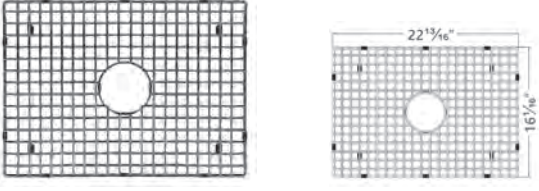
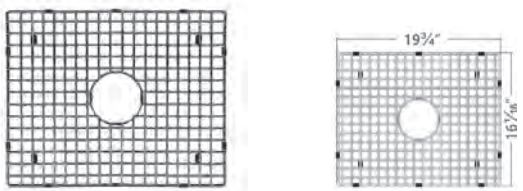
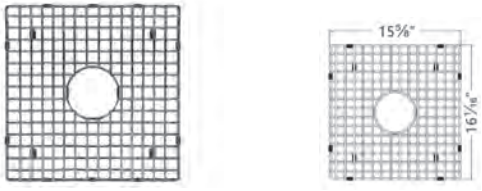
Bottom Grids	Model No.	List Price	Description
	G710	\$306.00	Premium Sink Bottom Grid For use with sink: SRU311710 Material: 304 Stainless Steel Finish: Polished Satin One-Year Limited Warranty
	G810	\$249.00	Premium Sink Bottom Grid For use with sinks: SRU281610, SRF321710 Material: 304 Stainless Steel Finish: Polished Satin One-Year Limited Warranty
	G811	\$221.00	Premium Sink Bottom Grid For use with sink: SRF281710 Material: 304 Stainless Steel Finish: Polished Satin One-Year Limited Warranty
	G812	\$210.00	Premium Sink Bottom Grid For use with sink: SRF251710 Material: 304 Stainless Steel Finish: Polished Satin One-Year Limited Warranty
	G813	\$176.00	Premium Sink Bottom Grid For use with sink: BSF201710 Material: 304 Stainless Steel Finish: Polished Satin One-Year Limited Warranty

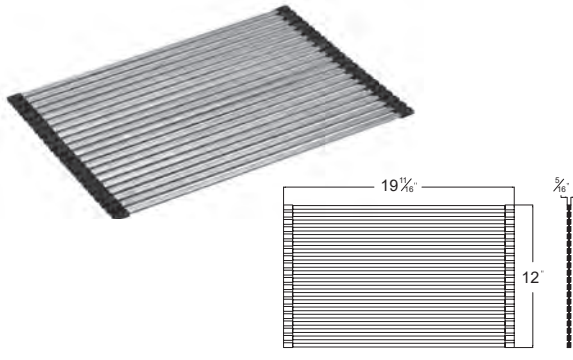
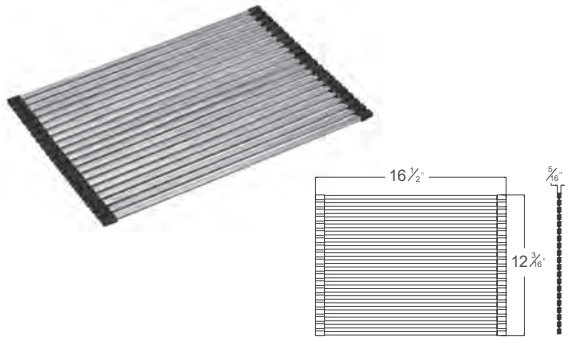
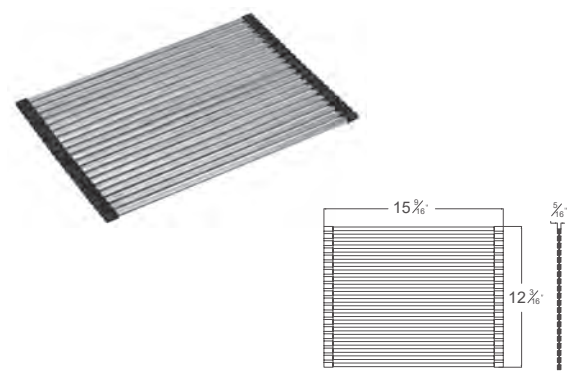
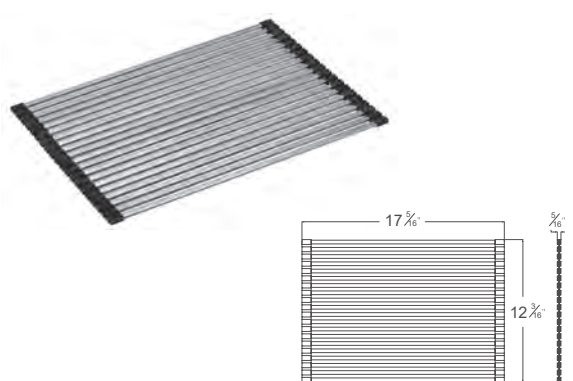
Drain Mats	Model No.	List Price	Description
 <p>3D perspective view of the DM001 drain mat. Below it is a 2D technical drawing showing a width of 19 3/8 inches and a height of 12 inches. A detail of the edge shows a thickness of 3/16 inch.</p>	DM001 (Black Rubber)	\$176.00	Universal Drain Mat (Compatible with all Dawn sinks) Material: 304 Stainless Steel Finish: Polished Satin & Rubber One-Year Limited Warranty
 <p>3D perspective view of the DM018 drain mat. Below it is a 2D technical drawing showing a width of 16 1/2 inches and a height of 12 3/8 inches. A detail of the edge shows a thickness of 3/16 inch.</p>	DM018 (Black Rubber)	\$117.00	Drain Mat For use with sinks: DAF3321L, DSU3018, DSQ2817, DSQ2917, DSQ301515 Material: 304 Stainless Steel Finish: Polished Satin & Rubber One-Year Limited Warranty
 <p>3D perspective view of the DM118 drain mat. Below it is a 2D technical drawing showing a width of 15 3/8 inches and a height of 12 3/8 inches. A detail of the edge shows a thickness of 3/16 inch.</p>	DM118 (Black Rubber)	\$140.00	Drain Mat For use with sink: DSU3118 Material: 304 Stainless Steel Finish: Polished Satin & Rubber One-Year Limited Warranty
 <p>3D perspective view of the DM710 drain mat. Below it is a 2D technical drawing showing a width of 17 3/8 inches and a height of 12 3/8 inches. A detail of the edge shows a thickness of 3/16 inch.</p>	DM710 (Black Rubber)	\$128.00	Drain Mat For use with sinks: DAFF3026, DAFF3326, DAFF3626, DAFF3026G, DAFF3326G, DAFF3626G, SRF251710, SRF281710, SRF321710, SRU281610, SRU311710, BSF201710 Material: 304 Stainless Steel Finish: Polished Satin & Rubber One-Year Limited Warranty

CB016

\$86.00

Cutting Board
For use with sink: 3235
Material: Solid Redwood
One-Year Limited Warranty

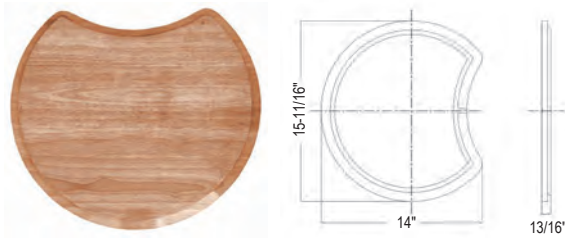

CB017

\$87.00

Cutting Board
For use with sinks: DAF3320,
DAF3320C, DAF3321L, DSQ2817,
DSQ2917, DSQ301515, DSU3017
For use with cabinets:
SSC3636G, SSC3636
Material: Solid Redwood
One-Year Limited Warranty



CB018

\$91.00

Cutting Board
For use with sink: DSU3018
Material: Solid Redwood
One-Year Limited Warranty









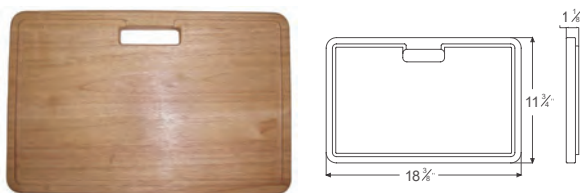

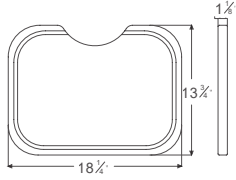

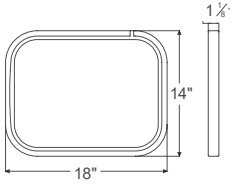

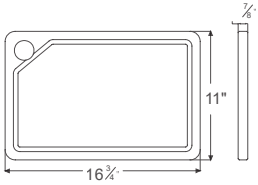

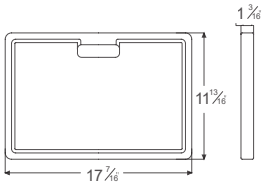

CB019

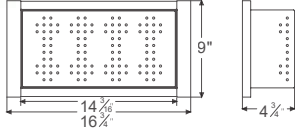
\$87.00

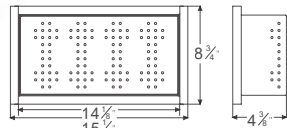
Cutting Board
For use with sinks: ASU106,
ASU2316, SRU311317L
For use with cabinets:
SSC3036G, SSC3036,
SSC3336G, SSC3336,
Material: Solid Redwood
One-Year Limited Warranty

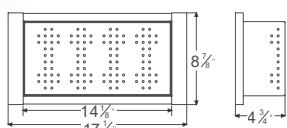

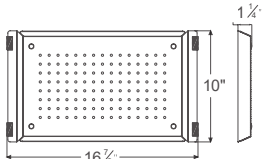
Cutting Boards	Model No.	List Price	Description
 	CB118	\$91.00	Cutting Board For use with sink: DSU3118 Material: Solid Redwood One-Year Limited Warranty
 	CB120	\$91.00	Cutting Board Material: Solid Redwood One-Year Limited Warranty
 	CB322	\$68.00	Cutting Board Material: Solid Redwood One-Year Limited Warranty
 	CB710	\$91.00	Cutting Board For use with sinks: DAFF3026, DAFF3326, DAFF3626, DAFF3626G, DAFF3326G, DAFF3026G, SRF251710, SRF281710, SRF321710, SRU281610, SRU311710 Material: Solid Redwood One-Year Limited Warranty

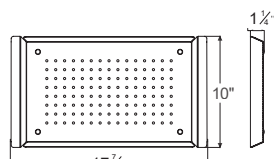
Colanders	Model No.	List Price	Description
 	COL018	\$186.00	Colander For use with sinks: DAF3321L, DSQ2817, DSQ2917, DSQ301515, DSU3018 Material: 304 Stainless Steel Finish: Polished Satin One-Year Limited Warranty
 	COL118	\$174.00	Colander For use with sink: DSU3118 Material: 304 Stainless Steel Finish: Polished Satin One-Year Limited Warranty
 	COL120	\$186.00	Colander Material: 304 Stainless Steel Finish: Polished Satin One-Year Limited Warranty
 	COL417	\$87.00	Colander Material: 304 Stainless Steel Finish: Polished Satin One-Year Limited Warranty
 	COL710	\$144.00	Colander For use with sinks: DAFF3026, DAFF3326, DAFF3626, DAFF3026G, DAFF3326G, DAFF3626G, SRF251710, SRF281710, SRF321710, SRU281610, SRU311710 Material: 304 Stainless Steel Finish: Polished Satin One-Year Limited Warranty

Drain Board Model No. List Price Description

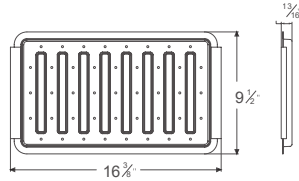

DB322 **\$53.00** Drain Board
 Material: 304 Stainless Steel
 Finish: Polished Satin
 One-Year Limited Warranty



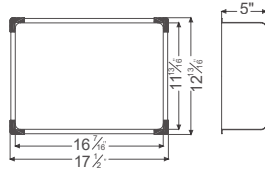

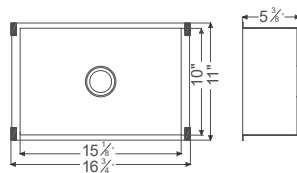

Trays Model No. List Price Description

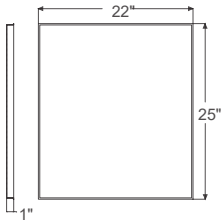

T710 **\$204.00** Tray
 For use with sinks: DAFF3026, DAFF3326, DAFF3626, DAFF3026G, DAFF3326G, DAFF3626G, SRU281610, SRU311710, SRF251710, SRF281710, SRF321710
 Material: 304 Stainless Steel
 Finish: Polished Satin
 One-Year Limited Warranty

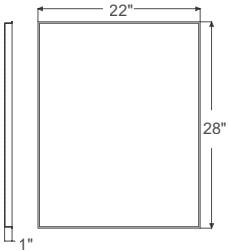

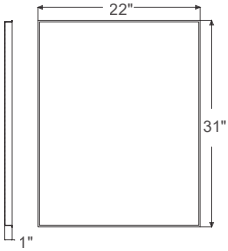

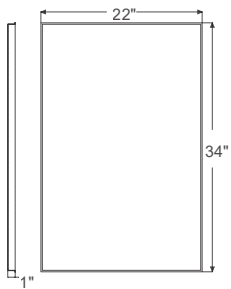





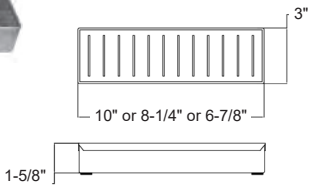

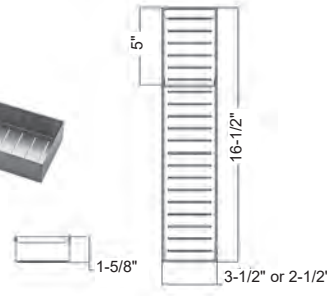
T817 **\$162.00** Tray
 For use with sink: DSQ2817
 Material: 304 Stainless Steel
 Finish: Polished Satin
 One-Year Limited Warranty

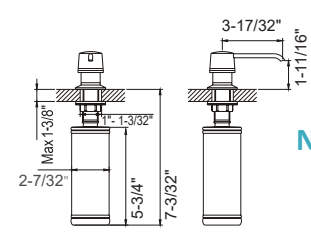
Stainless Steel Under Sink Trays		Model No.	List Price	Description
 		BT0252201	\$144.00	Under Sink Tray To be placed inside of your sink cabinet Material: 304 Stainless Steel Gauge: 20 Finish: Polished Satin Cabinet Size: 27" One-Year Limited Warranty
 		BT0282201	\$154.00	Under Sink Tray To be placed inside of your sink cabinet Material: 304 Stainless Steel Gauge: 20 Finish: Polished Satin Cabinet Size: 30" One-Year Limited Warranty
 		BT0312201	\$166.00	Under Sink Tray To be placed inside of your sink cabinet Material: 304 Stainless Steel Gauge: 20 Finish: Polished Satin Cabinet Size: 33" One-Year Limited Warranty
 		BT0342201	\$176.00	Under Sink Tray To be placed inside of your sink cabinet Material: 304 Stainless Steel Gauge: 20 Finish: Polished Satin Cabinet Size: 36" One-Year Limited Warranty

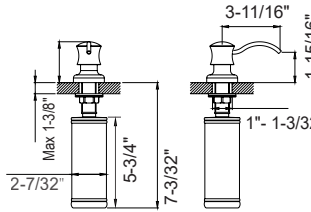

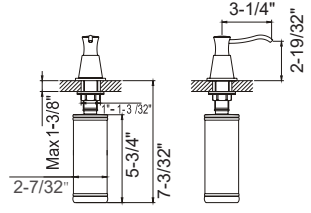
Baskets		Model No.	List Price	Description
 	BK3626	\$66.00	<p>Basket For use with sinks: DAFF3626, DAFF3326, DAFF3026, DAFF3626G, DAFF3326G, DAFF3026G Material: 304 Stainless Steel Finish: Polished Satin One-Year Limited Warranty</p>	
 	BK321710	\$78.00	<p>Basket For use with sinks: BSF201710, SRF251710, SRF281710, SRF321710 Material: 304 Stainless Steel Finish: Polished Satin One-Year Limited Warranty</p>	
 	BK710	\$34.00	<p>Basket For use with sinks: SRU281610, SRU311710 Material: 304 Stainless Steel Finish: Polished Satin One-Year Limited Warranty</p>	
Strainers		Model No.	List Price	Description
 	SD-01	\$18.00	<p>Strainer For use with Undermount and Top Mount Sinks Material: 304 Stainless Steel Finish: Polished Satin One-Year Limited Warranty</p>	
 	SD-33	\$23.00	<p>Strainer For use with Undermount and Top Mount Sinks Material: 304 Stainless Steel Finish: Polished Satin One-Year Limited Warranty</p>	
 	SD-39	\$23.00	<p>NEW Strainer For use with Undermount and Top Mount Sinks Material: 304 Stainless Steel Finish: Polished Satin One-Year Limited Warranty</p>	

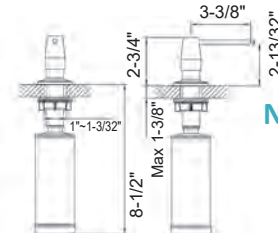
Utensil Shelves		Model No.	List Price	Description
 		T3626 (10" L)	\$78.00	Utensil Shelf T3626, for use with sinks: DAFF3626, DAFF3626G
		T3326 (8-1/4" L)	\$72.00	T3326, for use with sinks: DAFF3326, DAFF3326G
		T3026 (6-7/8" L)	\$66.00	T3026, for use with sinks: DAFF3026, DAFF3026G Material: 304 Stainless Steel Finish: Polished Satin One-Year Limited Warranty
 		T321710 (3-1/2" W)	\$88.00	Utensil Shelf T321710, for use with sinks: SRF251710, SRF281710, SRF321710
		T201710 (2-1/2" W)	\$88.00	T201710, for use with sink: BSF201710 Material: 304 Stainless Steel Finish: Polished Satin One-Year Limited Warranty
Soap/Lotion Dispensers		Model No.	List Price	Description
 		SD6306C Chrome	\$50.00	Liquid Soap/Lotion Dispenser Brass construction pump
		SD6306BN Brushed Nickel	\$66.00	Plastic clear bottle Refillable from top
		SD6306DBR Dark Brown	\$69.00	One-Year Limited Warranty
		SD6306GUG Gunmetal Grey	\$69.00	
		SD6306MB Matte Black	\$69.00	
		SD6306MAG Matte Gold	\$69.00	
 		SD6324DBR Dark Brown	\$76.00	Liquid Soap/Lotion Dispenser Brass construction pump Plastic clear bottle Refillable from top One-Year Limited Warranty
 		SD6325C Chrome	\$50.00	Liquid Soap/Lotion Dispenser Brass construction pump Plastic clear bottle
		SD6325BN Brushed Nickel	\$66.00	Refillable from top
		SD6325DBR Dark Brown	\$69.00	One-Year Limited Warranty
 		SD6369C Chrome	\$58.00	Liquid Soap/Lotion Dispenser Brass construction pump
		SD6369BN Brushed Nickel	\$72.00	Plastic clear bottle Refillable from top
		SD6369GUG Gunmetal Grey	\$76.00	One-Year Limited Warranty
		SD6369MB Matte Black	\$76.00	
		SD6369MAG Matte Gold	\$76.00	

Kitchen Faucets	Model No.	List Price	Description
	<p>AB04 3276C Chrome</p> <p>AB04 3276BN Brushed Nickel</p>	<p>\$268.00</p> <p>\$319.00</p>	<p>Single-Lever Faucet with Side Spray</p> <ul style="list-style-type: none"> • Solid brass construction • Ceramic disc cartridge • Single control operation • Flexible supply lines included • Pull-out side spray
	<p>AB04 3277C Chrome</p>	<p>\$279.00</p>	<p>Single-Lever Pull-Out Spray Faucet</p> <ul style="list-style-type: none"> • Solid brass construction • Ceramic disc cartridge • Dual control operation • Pull out spout with push button • Flexible supply lines included <p><u>Optional Accessory:</u> Escutcheon, 10"</p>  <p>D510013001C List \$32</p>
	<p>AB06 3296C Chrome</p>	<p>\$303.00</p>	<p>Single-Lever Faucet with Side Spray</p> <ul style="list-style-type: none"> • Solid brass construction • Ceramic disc cartridge • Single control operation • Flexible supply lines included • Pull-out side spray

Kitchen Faucets Model No. List Price Description



AB08 3157C **\$327.00**
Chrome

AB08 3157BN **\$392.00**
Brushed Nickel

- Single-Lever Pull-Out Spray Faucet
- Solid brass construction
 - Ceramic disc cartridge
 - Dual control operation
 - Pull out spout with push button
 - Flexible supply lines included

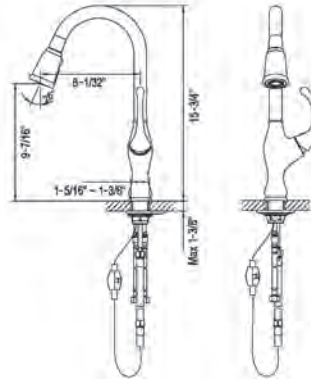

Optional Accessories:
Escutcheon, 10"



D510013001C List \$32
D510013001BN List \$37



AB08 3152C **\$286.00**
Chrome

AB08 3152BN **\$347.00**
Brushed Nickel

- Single-Lever Kitchen Faucet
- Solid brass construction
 - Ceramic disc cartridge
 - Single control operation
 - Flexible supply lines included

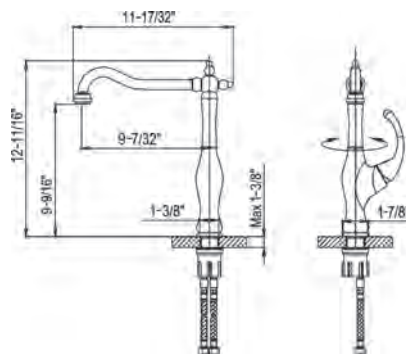

Optional Accessories:
Escutcheon, 10"



D510013001C List \$32
D510013001BN List \$37



AB08 3155C **\$319.00**
Chrome

- Single-Lever Faucet with Side Spray
- Solid brass construction
 - Ceramic disc cartridge
 - Single control operation
 - Flexible supply lines included
 - Pull-out side spray

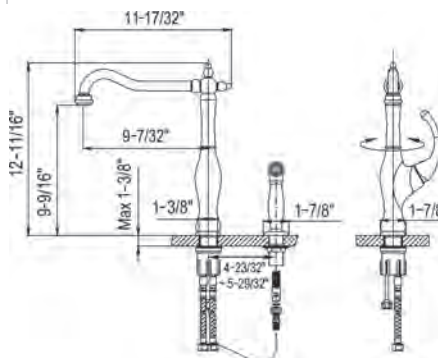

Kitchen Faucets	Model No.	List Price	Description
-----------------	-----------	------------	-------------



AB27 3602C
Chrome

\$340.00

Single-Lever Pull-Down Spray Faucet

- Solid brass construction
- Ceramic disc cartridge
- Dual control operation
- Pull out spout with push button
- Flexible supply lines included

Optional Accessory:
Escutcheon, 10"



D510013001C List \$32

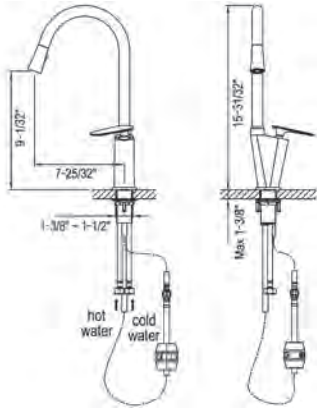

AB30 3788C
Chrome

\$352.00

Single-Lever Pull-Down Spray Faucet

- Solid brass construction
- Ceramic disc cartridge
- Dual control operation
- Pull out spout with push button
- Flexible supply lines included

AB30 3788BN
Brushed Nickel

\$401.00

Optional Accessory:
Escutcheon, 10"



D510013001C List \$32
D510013001BN List \$37

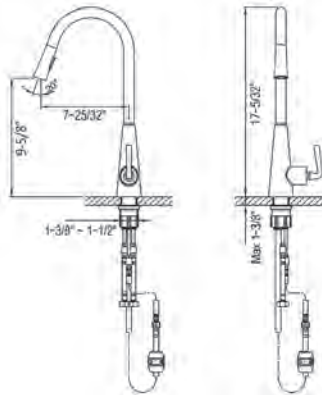

Kitchen Faucets Model No. List Price Description



AB33 3241C
Chrome

\$336.00

Single-Lever Pull-Out Faucet

- Solid brass construction
- Ceramic disc cartridge
- Single control operation
- Pull out spout
- Flexible supply lines included

AB33 3241BN
Brushed Nickel

\$377.00

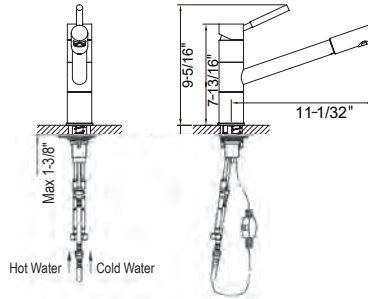

Optional Accessories:
Escutcheon, 10"



D510013001C List \$32
D510013001BN List \$37



AB50 3079C
Chrome

\$303.00

Single-Lever Pull-Out Spray Faucet

- Solid brass construction
- Ceramic disc cartridge
- Dual control operation
- Pull out spout with push button
- Flexible supply lines included

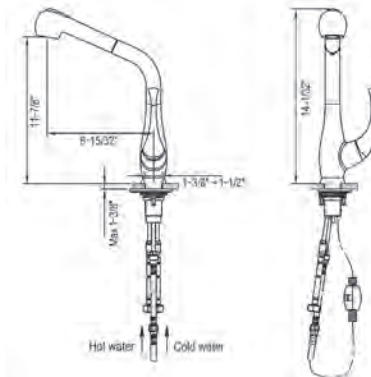

Optional Accessory:
Escutcheon, 10"



D510013001C List \$32



AB50 3084C
Chrome

\$322.00

Single-Lever Pull-Out Faucet

- Solid brass construction
- Ceramic disc cartridge
- Single control operation
- Pull out spout
- Flexible supply lines included

AB50 3084BN
Brushed Nickel

\$377.00

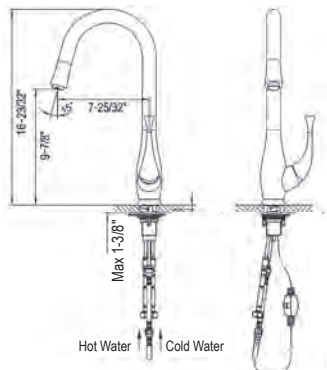

Optional Accessories:
Escutcheon, 10"



D510013001C List \$32
D510013001BN List \$37

Kitchen Faucets	Model No.	List Price	Description
	<p>AB50 3091C Chrome</p>	<p>\$322.00</p>	<p>Single-Lever Pull-Out Spray Faucet</p> <ul style="list-style-type: none"> • Solid brass construction • Ceramic disc cartridge • Dual control operation
	<p>AB50 3091BN Brushed Nickel</p>	<p>\$377.00</p>	<ul style="list-style-type: none"> • Pull out spout with push button • Flexible supply lines included
			<p><u>Optional Accessories:</u> Escutcheon, 10"</p>  <p>D510013001C List \$32 D510013001BN List \$37</p>
	<p>AB50 3178C Chrome</p>	<p>\$279.00</p>	<p>Single-Lever Faucet with Side Spray</p> <ul style="list-style-type: none"> • Solid brass construction • Ceramic disc cartridge • Single control operation • Flexible supply lines included • Pull-out side spray
			

*Original Design,
Exceptional Quality and
Pure Elegance for Modern Living.*

Kitchen Faucets Model No. List Price Description



AB50 3351C
Chrome

\$159.00

Single-Lever Kitchen Faucet

- Solid brass construction
- Ceramic disc cartridge
- Single control operation
- Flexible supply lines included

AB50 3351BN
Brushed Nickel

\$183.00

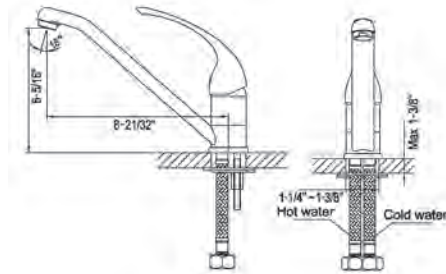

Optional Accessories:
Escutcheon, 10"



D510013001C List \$32

D510013001BN List \$37



AB50 3364C
Chrome

\$340.00

Single-Lever Spring Pull-Out
Spray Faucet

- Solid brass construction
- Ceramic disc cartridge
- Dual control operation
- Pull out spout with push button
- Flexible supply lines included

AB50 3364BN
Brushed Nickel

\$389.00

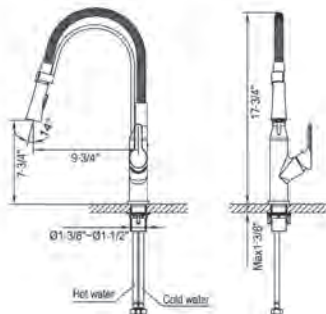

Optional Accessories:
Escutcheon, 10"



D510013001C List \$32

D510013001BN List \$37



Faucets



Matte Gold

Sensor Window

NEW

AB50 3262C
Chrome

\$452.00

Single-Lever Pull-Down
SENSOR Spray Faucet

AB50 3262BN
Brushed Nickel

\$525.00

- Solid brass construction
- Ceramic disc cartridge
- Two different sensor options:

AB50 3262GUG
Gunmetal Grey

\$525.00

- 1 By hands
- 2 By pull down or return spray

AB50 3262MB
Matte Black

\$525.00

- Sensor or normal operation
- Pull out spout with push button
- Flexible supply lines included
- Power supplied by DC 6V (4 pcs of AA 1.5V alkaline batteries required)

AB50 3262MAG
Matte Gold

\$525.00

- Water off after 180 seconds automatically

Optional Accessories:
Escutcheon, 10"



D510013001C List \$32

D510013001BN List \$37

D510013001GUG List \$37

D510013001MB List \$37

D510013001MAG List \$37



Gunmetal Grey



Matte Black



Chrome



Brushed Nickel

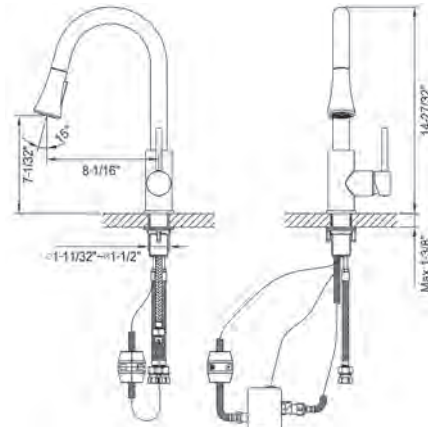
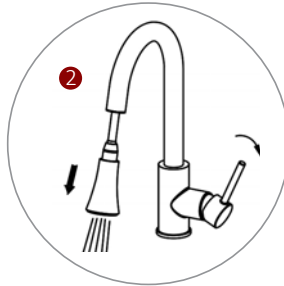

AB50 3316C
Chrome

\$331.00

Single-Lever Pull-Down Spray Faucet

AB50 3316BN
Brushed Nickel

\$380.00

- Solid brass construction
- Ceramic disc cartridge
- Dual control operation
- Pull out spout with push button
- Flexible supply lines included

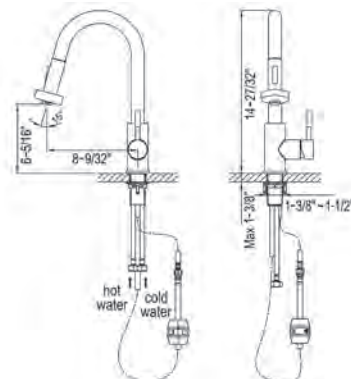

Optional Accessories:
Escutcheon, 10"



D510013001C List \$32

D510013001BN List \$37





Kitchen Faucets Model No. List Price Description



NEW

- AB50 3658C** **\$308.00** Single-Lever with Two Functions Pull-Out Spray Faucet
- Chrome
- AB50 3658BN** **\$359.00**
- Brushed Nickel
- AB50 3658GUG** **\$359.00**
- Gunmetal Grey
- AB50 3658MB** **\$359.00**
- Matte Black
- AB50 3658MAG** **\$359.00**
- Matte Gold
- AB50 3658MBPTG** **\$359.00**
- Spot Free Gold & Matte Black

Single-Lever with Two Functions Pull-Out Spray Faucet

- Solid brass construction
- Ceramic disc cartridge
- Dual control operation
- Pull out spout with push button
- Flexible supply lines included

Optional Accessories:

- Escutcheon, 10" 
- D510013001C List \$32
- D510013001BN List \$37
- D510013001GUG List \$37
- D510013001MB List \$37
- D510013001MAG List \$37

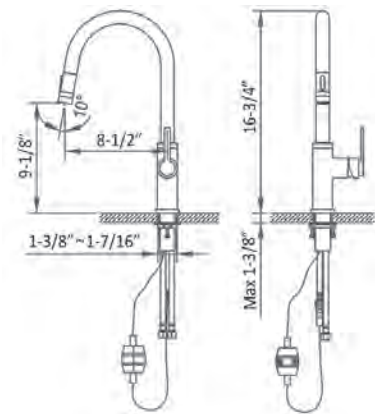

Faucets



NEW

- AB50 3666C** **\$297.00** Single-Lever Pull-Out Spray Faucet
- Chrome
- AB50 3666BN** **\$340.00**
- Brushed Nickel
- AB50 3666GUG** **\$340.00**
- Gunmetal Grey
- AB50 3666MB** **\$340.00**
- Matte Black
- AB50 3666MAG** **\$340.00**
- Matte Gold
- AB50 3666BMB** **\$340.00**
- Brushed Nickel & Matte Black







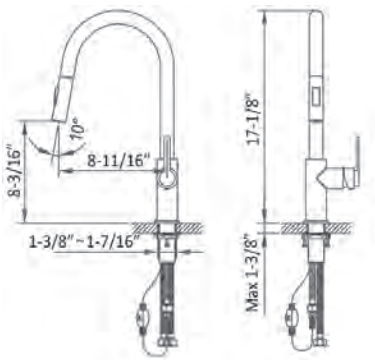

Single-Lever Pull-Out Spray Faucet

- Solid brass construction
- Ceramic disc cartridge
- Dual control operation
- Pull out spout with push button
- Flexible supply lines included

Optional Accessories:

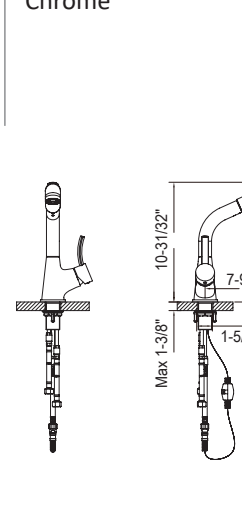
- Escutcheon, 10" 
- D510013001C List \$32
- D510013001BN List \$37
- D510013001GUG List \$37
- D510013001MB List \$37
- D510013001MAG List \$37

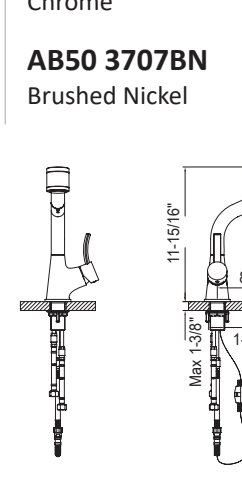

Kitchen Faucets	Model No.	List Price	Description
	AB50 3670C Chrome	\$340.00	Single-Lever Pull-Down Spray Faucet <ul style="list-style-type: none"> • Solid brass construction • Ceramic disc cartridge • Dual control operation • Pull out spout with push button • Flexible supply lines included
	AB50 3670BN Brushed Nickel	\$395.00	
			<p><u>Optional Accessories:</u> Escutcheon, 10"</p>  <p>D510013001C List \$32 D510013001BN List \$37</p>
	AB50 3703C Chrome	\$306.00	Single-Lever Pull-Out Spray Faucet <ul style="list-style-type: none"> • Solid brass construction • Ceramic disc cartridge • Dual control operation • Pull out spout with push button • Flexible supply lines included
			<p><u>Optional Accessories:</u> Escutcheon, 10"</p>  <p>D510013001C List \$32</p>
	AB50 3707C Chrome	\$312.00	Single-Lever Pull-Out Spray Faucet <ul style="list-style-type: none"> • Solid brass construction • Ceramic disc cartridge • Dual control operation • Pull out spout with switch • Flexible supply lines included
	AB50 3707BN Brushed Nickel	\$371.00	
			<p><u>Optional Accessories:</u> Escutcheon, 10"</p>  <p>D510013001C List \$32 D510013001BN List \$37</p>

Kitchen Faucets

Model No.

List Price

Description



AB50 3708C
Chrome

\$322.00

Single-Lever Pull-Out Spray Faucet

- Solid brass construction
- Ceramic disc cartridge
- Dual control operation
- Pull out spout with push button
- Flexible supply lines included

AB50 3708BN
Brushed Nickel

\$401.00

Optional Accessories:
Escutcheon, 10"



D510013001C List \$32
D510013001BN List \$37

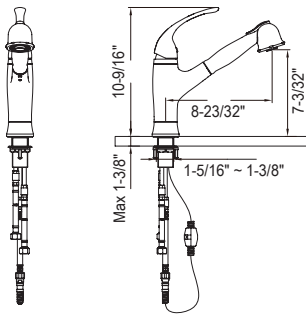

Faucets



AB50 3712C
Chrome

\$316.00

Single-Lever Pull-Out Spray Faucet

- Solid brass construction
- Ceramic disc cartridge
- Dual control operation
- Pull out spout with push button
- Flexible supply lines included

AB50 3712BN
Brushed Nickel

\$395.00

Optional Accessories:
Escutcheon, 10"



D510013001C List \$32
D510013001BN List \$37

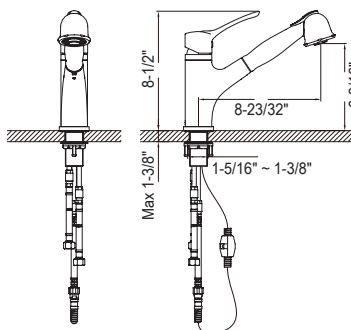

Kitchen Faucets Model No. List Price Description



AB50 3729C
Chrome

\$316.00

- Single-Lever Pull-Out Spray Faucet
- Solid brass construction
 - Ceramic disc cartridge
 - Dual control operation
 - Pull out spout with push button
 - Flexible supply lines included

AB50 3729BN
Brushed Nickel

\$363.00

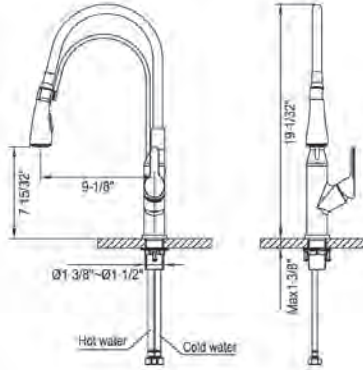

Optional Accessories:
Escutcheon, 10"



D510013001C List \$32
D510013001BN List \$37



AB50 3732C
Chrome

\$315.00

Single-Lever with Two Functions
Pull-Out Spray Faucet

- Solid brass construction
- Ceramic disc cartridge
- Magnetic Docking
- Dual control operation
- Pull out spout with push button
- Flexible supply lines included

AB50 3732BN
Brushed Nickel

\$368.00

NEW — **AB50 3732GUG**
Gunmetal Grey

\$399.00

AB50 3732MB
Matte Black

\$399.00

AB50 3732MAG
Matte Gold

\$399.00

Optional Accessories:
Escutcheon, 10"



D510013001C List \$32
D510013001BN List \$37
D510013001GUG List \$37
D510013001MB List \$37
D510013001MAG List \$37



Gunmetal Grey



Chrome



Matte Black



Brushed Nickel

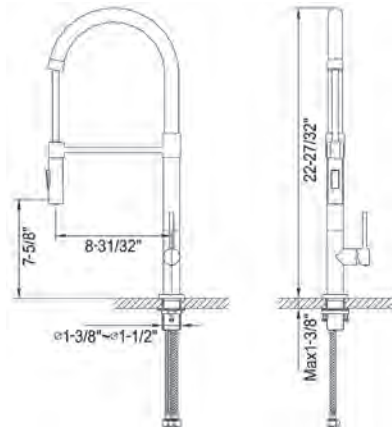

Kitchen Faucets Model No. List Price Description



Matte Gold

- AB50 3776C** **\$310.00**
Chrome
- AB50 3776BN** **\$347.00**
Brushed Nickel
- NEW** — **AB50 3776GUG** **\$368.00**
Gunmetal Grey
- AB50 3776MB** **\$368.00**
Matte Black
- AB50 3776MAG** **\$368.00**
Matte Gold

Single-Lever Pull-Out Spray Faucet

- Solid brass construction
- Ceramic disc cartridge
- Dual control operation
- Pull out spout with push button
- Flexible supply lines included

Optional Accessories:
Escutcheon, 10"



- D510013001C** List \$32
- D510013001BN** List \$37
- D510013001GUG** List \$37
- D510013001MB** List \$37
- D510013001MAG** List \$37



Gunmetal Grey

Matte Black



Chrome

Brushed Nickel

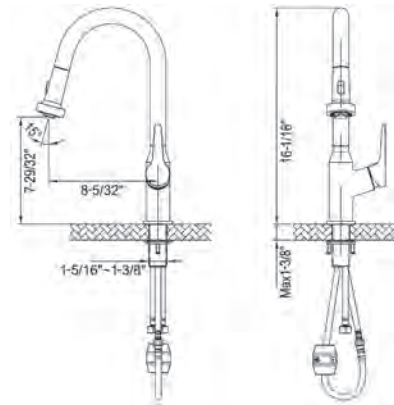

Faucets



Matte Black

- AB50 3777C** **\$336.00**
Chrome
- AB50 3777BN** **\$378.00**
Brushed Nickel
- NEW** — **AB50 3777GUG** **\$410.00**
Gunmetal Grey
- AB50 3777MB** **\$410.00**
Matte Black
- AB50 3777MAG** **\$410.00**
Matte Gold

Single-Lever Spring Pull-Out Faucet

- Solid brass construction
- Ceramic disc cartridge
- Dual control operation
- Pull out spout with push button
- Flexible supply lines included

Optional Accessories:
Escutcheon, 10"



- D510013001C** List \$32
- D510013001BN** List \$37
- D510013001GUG** List \$37
- D510013001MB** List \$37
- D510013001MAG** List \$37



Gunmetal Grey

Matte Gold



Chrome

Brushed Nickel

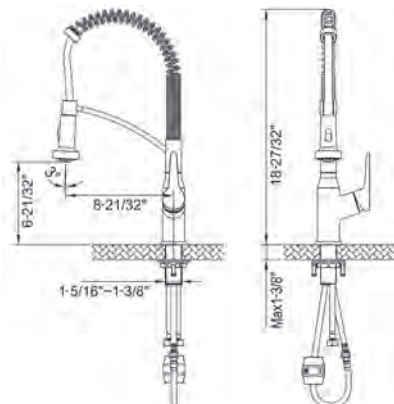

Kitchen Faucets	Model No.	List Price	Description
-----------------	-----------	------------	-------------



Matte Gold

AB50 3778C
Chrome

\$305.00

Single-Lever Pull-Down Spray Faucet

- Solid brass construction
- Ceramic disc cartridge
- Dual control operation
- Pull out spout with push button
- Flexible supply lines included

AB50 3778BN
Brushed Nickel

\$347.00

NEW **AB50 3778GUG**
Gunmetal Grey

\$347.00

Optional Accessories:
Escutcheon, 10"

AB50 3778MB
Matte Black

\$347.00



AB50 3778MAG
Matte Gold

\$347.00

- | | |
|----------------------|-----------|
| D510013001C | List \$32 |
| D510013001BN | List \$37 |
| D510013001GUG | List \$37 |
| D510013001MB | List \$37 |
| D510013001MAG | List \$37 |



Gunmetal Grey



Matte Black



Chrome



Brushed Nickel

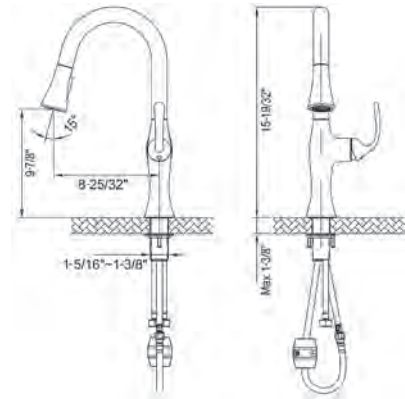

Matte Black

AB50 3787C
Chrome

\$483.00

2 Way Spring Pull-Out Faucet

- Solid brass construction
- Ceramic disc cartridge
- Dual control operation
- Pull out spout with push button
- Flexible supply lines included

AB50 3787BN
Brushed Nickel

\$546.00

NEW **AB50 3787GUG**
Gunmetal Grey

\$609.00

Optional Accessories:
Escutcheon, 10"

AB50 3787MB
Matte Black

\$609.00



AB50 3787MAG
Matte Gold

\$609.00

- | | |
|----------------------|-----------|
| D510013001C | List \$32 |
| D510013001BN | List \$37 |
| D510013001GUG | List \$37 |
| D510013001MB | List \$37 |
| D510013001MAG | List \$37 |



Gunmetal Grey



Matte Gold



Chrome



Brushed Nickel

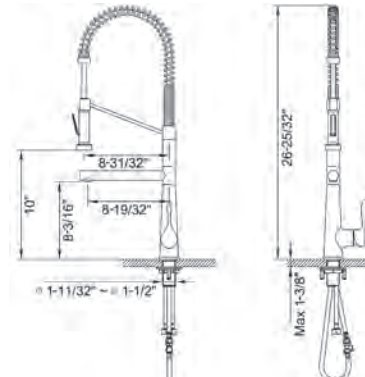

Dawn®



Faucets



Kitchen Faucets	Model No.	List Price	Description
-----------------	-----------	------------	-------------



NEW

Chrome

AB50 3799C
Chrome

\$302.00

Single-Lever Pull-Out Spray Faucet
 • Solid brass construction
 • Ceramic disc cartridge
 • Dual control operation
 • Pull out spout with push button
 • Flexible supply lines included

AB50 3799BN
Brushed Nickel

\$348.00

AB50 3799GUG
Gunmetal Grey

\$348.00

AB50 3799MB
Matte Black

\$348.00

AB50 3799MAG
Matte Gold

\$348.00

Optional Accessories:
Escutcheon, 10"



- D510013001C List \$32
- D510013001BN List \$37
- D510013001GUG List \$37
- D510013001MB List \$37
- D510013001MAG List \$37



Gunmetal Grey



Brushed Nickel



Matte Black



Matte Gold

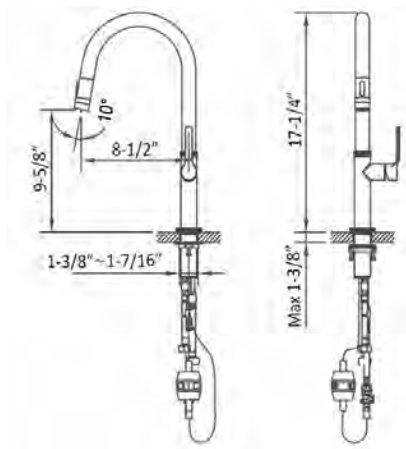

Kitchen Faucets Model No. List Price Description



AB53 3498C
Chrome

\$280.00

Single-Lever Pull-down Spray Faucet

- Solid brass construction
- Ceramic disc cartridge
- Dual control operation
- Pull out spout with push button
- Flexible supply lines included

AB53 3498BN
Brushed Nickel

\$328.00

Optional Accessories:

Escutcheon, 10"

D510013001C List \$32

D510013001BN List \$37

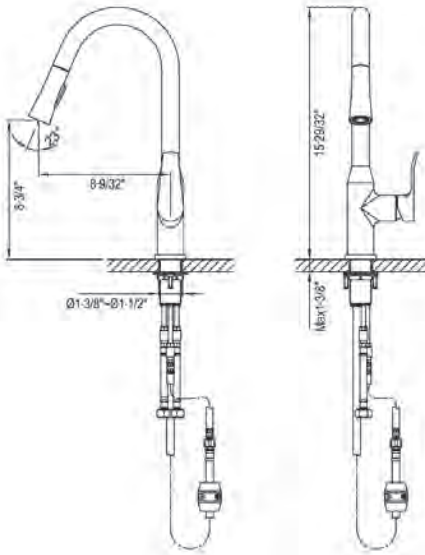

Faucets



AB75 3383C
Chrome

\$377.00

Single-Lever Spring Pull-out Faucet

- Solid brass construction
- Ceramic disc cartridge
- Dual control operation
- Pull out spout with push button
- Flexible supply lines included

AB75 3383BN
Brushed Nickel

\$432.00

Optional Accessories:

Escutcheon, 10"

D510013001C List \$32

D510013001BN List \$37

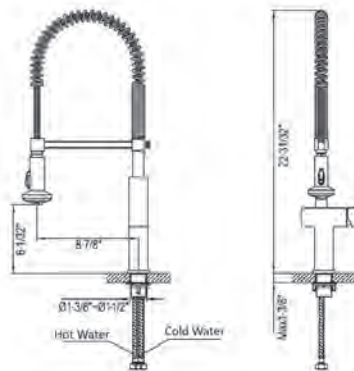

Bar Faucets	Model No.	List Price	Description
-------------	-----------	------------	-------------



AB50 3655C
Chrome

\$226.00

- Single-Lever Bar Faucet
- Solid brass construction
 - Ceramic disc cartridge
 - Single control operation
 - Flexible supply lines included

AB50 3655BN
Brushed Nickel

\$259.00

AB50 3655GUG
Gunmetal Grey

\$259.00

AB50 3655MB
Matte Black

\$259.00

AB50 3655MAG
Matte Gold

\$259.00

AB50 3655MBPTG
Spot Free Gold
& Matte Black

\$259.00

Optional Accessories:
Escutcheon, 6"



- | | |
|---------------|-----------|
| D520013001C | List \$14 |
| D520013001BN | List \$17 |
| D520013001GUG | List \$17 |
| D520013001MB | List \$17 |
| D520013001MAG | List \$17 |



Chrome



Brushed Nickel



Gunmetal Grey



Matte Black



Matte Gold

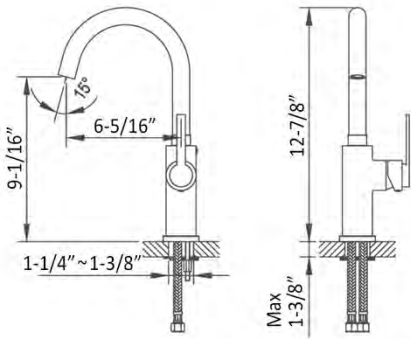

Bar Faucets Model No. List Price Description



AB50 3714BN
Brushed Nickel

\$313.00

- Single-Lever Bar Faucet
- Solid brass construction
 - Ceramic disc cartridge
 - Single control operation
 - Flexible supply lines included

Optional Accessories:
Escutcheon, 6"



D520013001BN List \$17

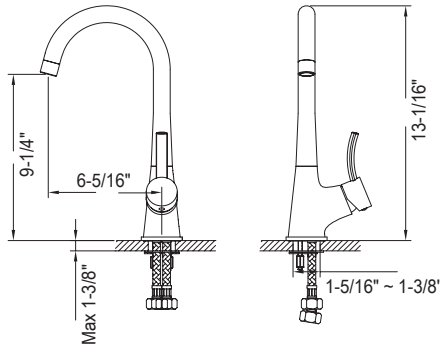

AB50 3715C
Chrome

\$268.00

- Single-Lever Bar Faucet
- Solid brass construction
 - Ceramic disc cartridge
 - Single control operation
 - Flexible supply lines included

AB50 3715BN
Brushed Nickel

\$348.00

Optional Accessories:
Escutcheon, 6"



D520013001C List \$14
D520013001BN List \$17

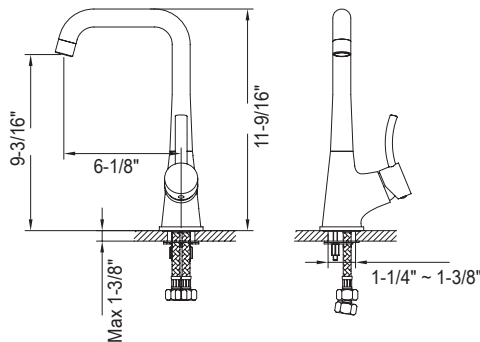

Faucets