

Price List 2023 USA

Valid from 07.01.2023

HOMEA
PREMIUM

HOMEA

www.homea.mx

Email: ventas@homea.mx

Whatsapp: (442)258.0251

Tel: (442)216.3552

Lada sin Costo: 01(800)701.2121

Ideal Kitchen Workstations.. Handcrafted in the USA.

THEGALLEY
REINVENT YOUR KITCHEN

Collection Changes 2023

New Products

American Black Walnut

We are now offering American Black Walnut as a Finish for all Workstations. With its exceptional durability and stunning dark hues, this premium 3/4" thick wood is the perfect complement to our beautiful selection of Culinary Tool Materials & Finishes.

See page

9

Ideal ThinTop™ Workstations

The ThinTop™ Galley Workstation has been designed to accommodate thinner and ultracompact kitchen countertop surfaces made of materials such as ceramic or porcelain. The ThinTop Workstations integrate the Upper Tier below the Basin flange, effectively eliminating the requirement for a thick countertop. The result is a sleek, low-profile look that is both aesthetically pleasing and highly practical.

65

Custom Workstations

We have expanded our custom capabilities even further, enabling you to personalize your Workstation in a wide variety of ways. We offer the option to make any Workstation a ThinTop™, Add Bowl to Workstations 5' and above, Top Mount/Flush Mount options, and much more.

77

citrine. Wood Finishing Balm

Our citrine. Wood Finishing Balm nourishes and safeguards wood surfaces leaving them with a natural, long-lasting shine. It is NSF-registered and food-safe.

91



TABLE OF CONTENTS

INTRODUCTION	PAGE
Collection Changes 2023	
Product Highlights	01 - 06
GALLEY WORKSTATIONS	
Workstation	07 - 15
Corner Workstation	17 - 21
WashStation™	23 - 29
Corner WashStation™	31 - 35
Work&WashStation™	37 - 42
BarStation	43 - 46
HydroStation™	47 - 48
DryDock	49 - 64
ThinTop™	65 - 76
Custom	77 - 80
Upper Deck	81 - 83
Basin Accessories	84
Optional Culinary Tools	85 - 90
citrine	91 - 92

GALLEY TAP	
Tap	93-108
Tap Accessories	109-110
Water Filtration System	111

GENERAL INFORMATION	
Use and Care	113-114
Kitchen Layout Types	115-116
General Sales Terms & Conditions	117-118
Warranty	119-122
Product Index	123-145
Notes	146-148

THE GALLEY
REINVENT YOUR KITCHEN

The Galley, LLC Headquarters & Showroom
12626 South Memorial Drive
Bixby, OK 74008

The Galley Midwest Office & Showcase
The Merchandise Mart, First Floor
Chicago, IL 60654

TheGalley.com

800 375 4255



Life in the kitchen has never been this good

The kitchen is about much more than making a meal; it's the heart of the home. The Galley was created to make life in the kitchen easier, more efficient and more enjoyable. Discover how a highly functional and social kitchen revolves around the Galley Workstation.

REINVENT YOUR KITCHEN.

Ideal Workstation 7S with Graphite Wood Composite Culinary Tools, Bamboo Chef's Block and Recessed Knife Block, Matte Stainless Steel Taps

A BETTER WAY.



PREPARE STATION



COOK STATION



SERVE STATION



ENTERTAIN STATION



CLEAN STATION



PREPARE: RINSE



SERVE: GARNISH



CLEAN: SOAK

PREPARE | COOK | SERVE | ENTERTAIN | CLEAN

In your Galley, you can chop, strain, and mix easily and ergonomically to prepare a meal and efficiently transition to cooking with a cooktop nearby. Using various Serving Boards, quickly and conveniently transform your prepare and cook station into a serve station or set out drinks and hors d'oeuvres to create an ideal entertain station. Contain the mess within your Galley and clean throughout preparing, cooking, serving, and entertaining!

DESIGN YOUR GALLEY

WORKSTATION TYPE

Workstation
 WashStation™
 Work&WashStation™
 BarStation.
 HydroStation™

WORKSTATION SIZE

7' Workstation | Work&WashStation
 6' Workstation | Work&WashStation
 5' Workstation | Work&WashStation
 4' Workstation | WashStation | Work&WashStation
 4'X4' Corner Workstation | Corner WashStation
 4'X3' Corner Workstation | Corner WashStation
 3' Workstation | WashStation
 2.5' Workstation | WashStation
 2' Workstation | WashStation | BarStation
 1.5' BarStation
 1' HydroStation

ADD A DRYDOCK.

18" DryDock
 12" DryDock

MAKE IT A THINTOP™

Ideal for ultracompact kitchen countertop surfaces (porcelain or ceramic). By integrating the Upper Tier below the Basin flange, this Workstation eliminates the need for a thick countertop.

CUSTOMIZE

Personalize any size, drain & divider location, integrate an apron front or WorkTop™ and create the Ideal Workstation for your kitchen.

CULINARY KIT/TOOL MATERIALS

■ 3/4" American Black Walnut
 ■ 1/2" Graphite Wood Composite
 ■ 3/4" Natural Golden Bamboo
 ■ 5/8" Exclusive Gray Resin
 ■ 5/8" Designer White Resin

BASIN ACCESSORIES

Bottom Grates
 Strainer Baskets & Disposal Flanges

UPPER DECK.

Complete Sets ■■■■■
 Individual Sections 24", 20", 18", 12", 9", 6" ■■■■■

OPTIONAL CULINARY TOOLS/KITS

Dual Tier Wash & Serve Set ■■■■■
 Upper & Dual Tier Condiment Serving Boards ■■■■■
 Upper & Dual Tier 2" thick Chef's Blocks ■■
 Upper Tier Garnish Board ■■■■■
 Upper Tier Utensil Caddy ■■■■■
 Knife Block ■■■
 Aluminum Half Sheet Pan ■
 Wash Caddy ■■■ Wash Bowl ■■■
 Entertain Kit ■■■■■ Outdoor Kit ■■■
 Corner Kit ■■■■■

TAP FINISHES

● Polished Stainless Steel
 ● Matte Stainless Steel
 ● PVD Gun Metal Gray™ Stainless Steel
 ● PVD Satin Black Stainless Steel
 ● PVD Polished Rose Gold Stainless Steel *Limited Edition*
 ● PVD Brushed Gold Stainless Steel *Limited Edition*

TAPS

Tap ●●●●●
 BarTap. ●●●●●
 Hot & Cold Tap ●●●●●
 Pot Filler Tap ●●●●●
 Water Filtration System

TAP ACCESSORIES

Soap Dispenser ●●●●●
 Deck Switch ●●●●●
 Air Gap ●●●●●



Ideal Workstation 7S with Graphite Wood Composite Culinary Kit and Upper Deck, Matte Stainless Steel Taps, Hot & Cold Tap, Soap Dispenser, and Deck Switch



THE GALLEY WORKSTATION.

The Ultimate Culinary System

G

THE ORIGINAL KITCHEN WORKSTATION™

The Galley represents a whole new category of kitchen appliance. A complete culinary system where one can prepare, cook, serve, entertain, and clean all in one central and convenient place. The kitchen is even more functional and ergonomic with the Workstation near cooking. This evolutionary kitchen work line concept is much more efficient than the traditional work triangle layout. Simply put, The Galley System is A Better Way. Each Galley is thoughtfully designed, engineered and hand-crafted in the USA. ★ ★ ★ ★

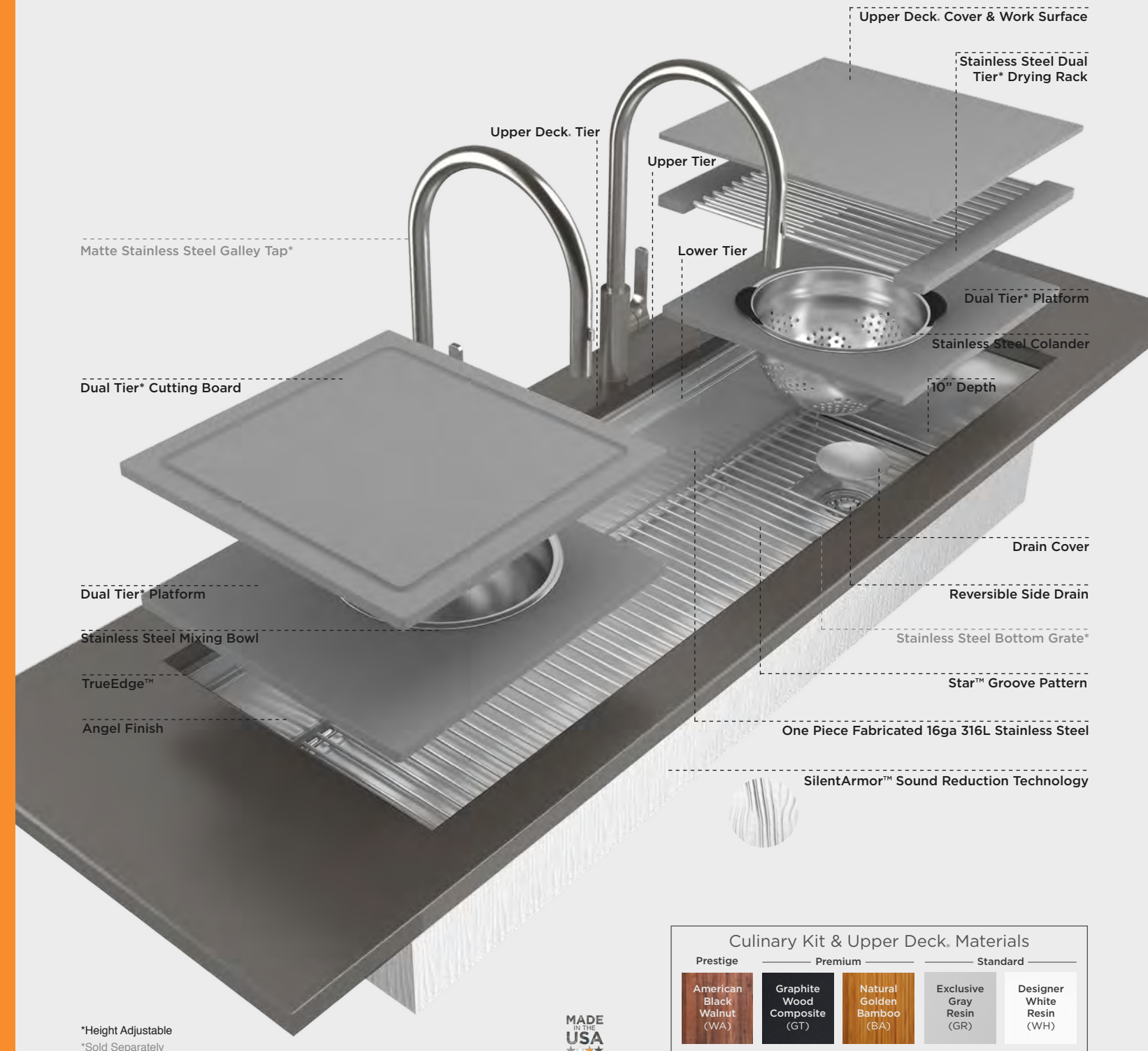



Ideal Workstation 4S with Exclusive Gray Resin Culinary Kit, Walnut Chef's Block, Matte Stainless Steel Tap, Soap Dispenser, and Deck Switch

Eliminate every reason why you don't like to cook

The Galley makes everything in your kitchen easier and more enjoyable. Slide the Galley Culinary Tools above and below each other to prepare a meal efficiently. Invite others to join in the fun and work side-by-side at a two or three person Workstation. Stay engaged and enjoy spending quality time with your family and friends around the Galley. Eliminate time-consuming clean up by preparing, cooking, serving and entertaining within the Workstation.

Make the problems of your kitchen disappear



IDEAL WORKSTATIONS

IWS-7-S Eight Dual Tier Culinary Tools
X-LARGE 



IWS-6-S Eight Dual Tier Culinary Tools
LARGE 



IWS-5-S Eight Dual Tier Culinary Tools
MEDIUM 



IWS-4-S Five Single Tier Culinary Tools
SMALL 



IWS-3-S Five Single Tier Culinary Tools
X-SMALL 

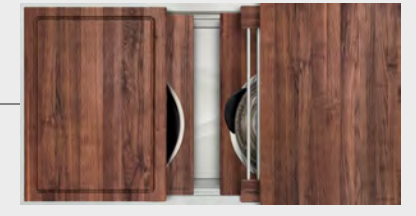

IWS-30-S Five Single Tier Culinary Tools
XX-SMALL 



IWS-2-C Five Single Tier Culinary Tools
MINI 



Ideal Workstation. 7S

IWS-7-S-WA MSRP \$7,695 UMRP \$6,926



American Black Walnut

IWS-7-S-GT MSRP \$7,195 UMRP \$6,476

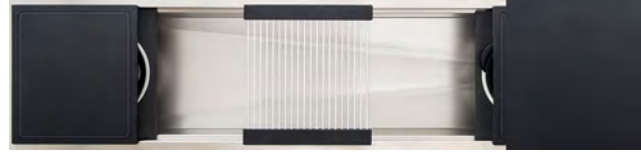

Graphite Wood Composite

IWS-7-S-BA MSRP \$7,195 UMRP \$6,476



Natural Golden Bamboo

IWS-7-S-GR MSRP \$6,795 UMRP \$6,116



Exclusive Gray Resin*

IWS-7-S-WH MSRP \$6,795 UMRP \$6,116



Designer White Resin*

Culinary Tools included (CKT-17)

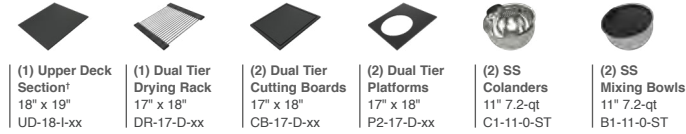

For Optional Culinary Tools see pages 85-90

* The Upper Deck requires a 1/4" clearance below the surface of the countertop. If the countertop thickness is 3/4" or less, Walnut or Bamboo Upper Deck sections will not have the clearance to function above the Upper Tier Culinary Tools.

Upper Deck.

Cover set UD-7-4P-WA/GT/BA/GR/WH Walnut, Graphite, Bamboo, Gray or White Resin

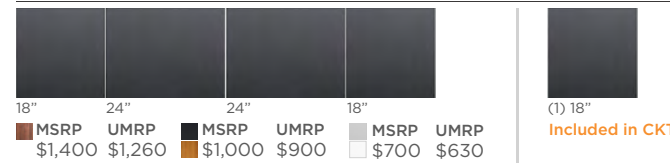

Sections Walnut, Graphite, Bamboo, Gray or White Resin



Specifications

Single bowl
Users: 1-3
Culinary Tools included: Eight
Galley Taps recommended: Two
Outside dimensions: 81 1/2" x 19 1/2" x 10 5/16"
Interior dimensions: 80" x 17" x 10"
Countertop cutout: 80 1/2" x 18"
Basin area: 80" x 16"
Minimum cabinet size: 84" or 210cm

Basin (KSO-7-S-SS)

16GA 316L stainless steel indoor/outdoor
SilentArmor™ sound reduction technology
Angel finish
Three tier design
Star™ groove pattern
Reversible side drain
Drain cover included
Limited Lifetime Warranty
Made in the USA
ASME A112.19.3/CSA B45.4 certified
cUPC™ certified

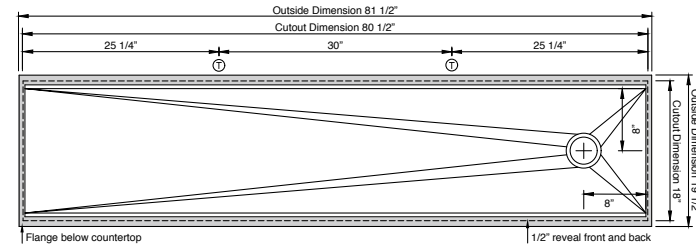

Center Galley Tap holes 2" from the back of the 18" countertop cutout

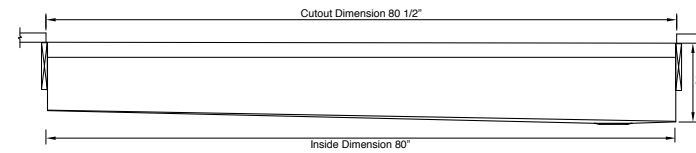

Customize Your Galley

Add 7-12" length	\$1,200	p. 80	9" depth	\$300	p. 80
Add 1-6" length	\$900	p. 80	Center drain	\$300	p. 80
Add 18" DryDock	\$1,800	p. 79	ThinTop™	\$500	p. 79
Add 12" DryDock	\$1,500	p. 79	WorkTop™	Custom	p. 79
Apron front	\$2,900	p. 79	*Color coded labels available		p. 87

For Galley Tap Suite see pages 93-112
For Freight see page 117

Recommended Basin Accessories & citrine.

Bottom Grate set BG-7-S-3-SS Stainless Steel

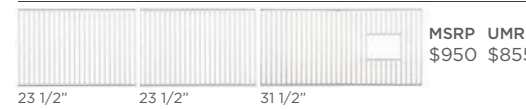

CIT-09-SS-C



CIT-09-WD-C



CIT-04-WD-B

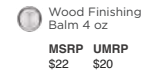

Strainer M-DRN-MSS
Angel Finish 304 Stainless Steel



Disposal Strainer G-DRN-MSS
Angel Finish 304 Stainless Steel

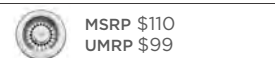

Auto Strainer Angel Finish 304 Stainless Steel with Polished or Matte knob



A-DRN-MSS shown

Ideal Workstation. 6S

IWS-6-S-WA MSRP \$7,095 UMRP \$6,386



American Black Walnut

IWS-6-S-GT MSRP \$6,595 UMRP \$5,936



Graphite Wood Composite

IWS-6-S-BA MSRP \$6,595 UMRP \$5,936



Natural Golden Bamboo

IWS-6-S-GR MSRP \$6,195 UMRP \$5,576



Exclusive Gray Resin*

IWS-6-S-WH MSRP \$6,195 UMRP \$5,576



Designer White Resin*

Culinary Tools included (CKT-17)

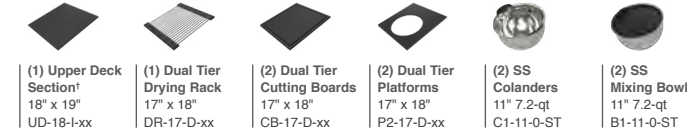

For Optional Culinary Tools see pages 85-90

* The Upper Deck requires a 1/4" clearance below the surface of the countertop. If the countertop thickness is 3/4" or less, Walnut or Bamboo Upper Deck sections will not have the clearance to function above the Upper Tier Culinary Tools.

Upper Deck.

Cover set UD-6-3P-WA/GT/BA/GR/WH Walnut, Graphite, Bamboo, Gray or White Resin

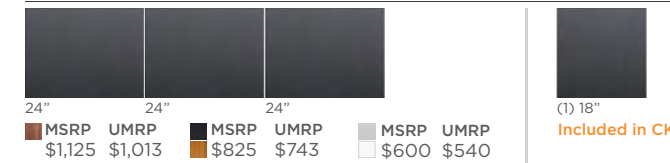

Sections Walnut, Graphite, Bamboo, Gray or White Resin



Specifications

Single bowl
Users: 1-2
Culinary Tools included: Eight
Galley Taps recommended: Two
Outside dimensions: 69 1/2" x 19 1/2" x 10 5/16"
Interior dimensions: 68" x 17" x 10"
Countertop cutout: 68 1/2" x 18"
Basin area: 68" x 16"
Minimum cabinet size: 72" or 180cm

Basin (KSO-6-S-SS)

16GA 316L stainless steel indoor/outdoor
SilentArmor™ sound reduction technology
Angel finish
Three tier design
Star™ groove pattern
Reversible side drain
Drain cover included
Limited Lifetime Warranty
Made in the USA
ASME A112.19.3/CSA B45.4 certified
cUPC™ certified

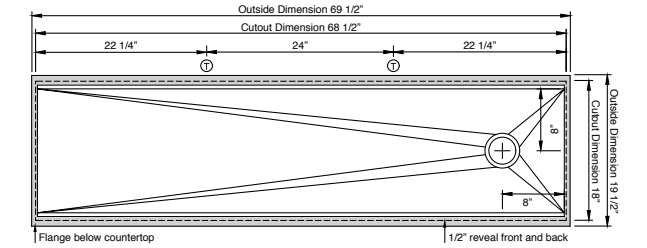

Center Galley Tap holes 2" from the back of the 18" countertop cutout

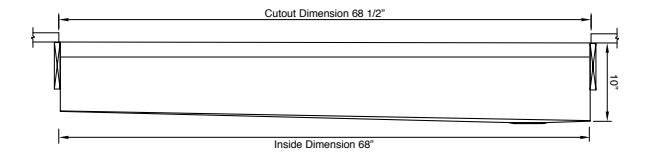

Customize Your Galley

Add 7-12" length	\$1,200	p. 80	9" depth	\$300	p. 80
Add 1-6" length	\$900	p. 80	Center drain	\$300	p. 80
Add 18" DryDock	\$1,800	p. 79	ThinTop™	\$500	p. 79
Add 12" DryDock	\$1,500	p. 79	WorkTop™	Custom	p. 79
Apron front	\$2,700	p. 79	*Color coded labels available		p. 87

For Galley Tap Suite see pages 93-112
For Freight see page 117

Recommended Basin Accessories & citrine.

Bottom Grate set BG-6-S-3-SS Stainless Steel

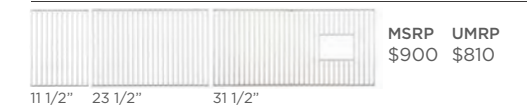

CIT-09-SS-C



CIT-09-WD-C

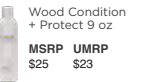

CIT-04-WD-B

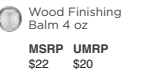

Strainer M-DRN-MSS
Angel Finish 304 Stainless Steel



Disposal Strainer G-DRN-MSS
Angel Finish 304 Stainless Steel

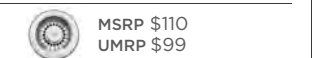

Auto Strainer Angel Finish 304 Stainless Steel with Polished or Matte knob



A-DRN-MSS shown

Ideal Workstation. 5S

IWS-5-S-WA MSRP \$6,495 UMRP \$5,846



American Black Walnut

IWS-5-S-GT MSRP \$5,995 UMRP \$5,396



Graphite Wood Composite

IWS-5-S-BA MSRP \$5,995 UMRP \$5,396

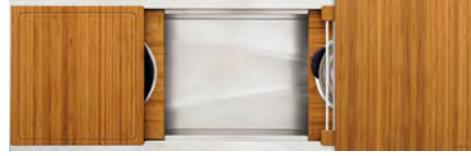

Natural Golden Bamboo

IWS-5-S-GR MSRP \$5,595 UMRP \$5,036



Exclusive Gray Resin*

IWS-5-S-WH MSRP \$5,595 UMRP \$5,036



Designer White Resin*

Culinary Tools included (CKT-17)

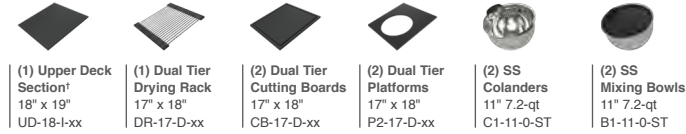

- (1) Upper Deck Section† 18" x 19" UD-18-l-xx
- (1) Dual Tier Drying Rack 17" x 18" DR-17-D-xx
- (2) Dual Tier Cutting Boards 17" x 18" CB-17-D-xx
- (2) Dual Tier Platforms 17" x 18" P2-17-D-xx
- (2) SS Colanders 11" 7.2-qt C1-11-0-ST
- (2) SS Mixing Bowls 11" 7.2-qt B1-11-0-ST

For Optional Culinary Tools see pages 85-90

† The Upper Deck requires a 1/4" clearance below the surface of the countertop. If the countertop thickness is 3/4" or less, Walnut or Bamboo Upper Deck sections will not have the clearance to function above the Upper Tier Culinary Tools.

Upper Deck.

Cover set UD-5-3P-WA/GT/BA/GR/WH Walnut, Graphite, Bamboo, Gray or White Resin

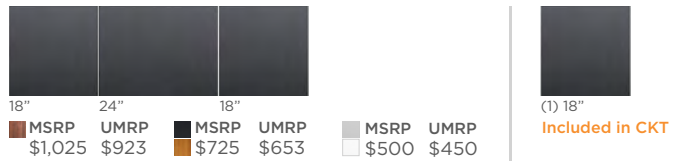

Sections Walnut, Graphite, Bamboo, Gray or White Resin



Specifications

Single bowl
Users: 1-2
Culinary Tools included: Eight
Galley Taps recommended: Two
Outside dimensions: 57 1/2" x 19 1/2" x 10 5/16"
Interior dimensions: 56" x 17" x 10"
Countertop cutout: 56 1/2" x 18"
Basin area: 56" x 16"
Minimum cabinet size: 60" or 150cm

Basin (KSO-5-S-SS)

16GA 316L stainless steel indoor/outdoor
SilentArmor™ sound reduction technology
Angel finish
Three tier design
Star™ groove pattern
Reversible side drain
Drain cover included
Limited Lifetime Warranty
Made in the USA
ASME A112.19.3/CSA B45.4 certified
cUPC™ certified

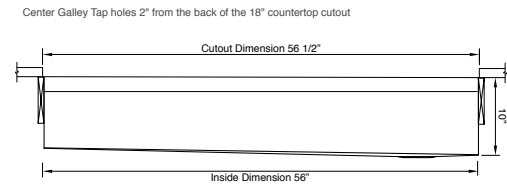
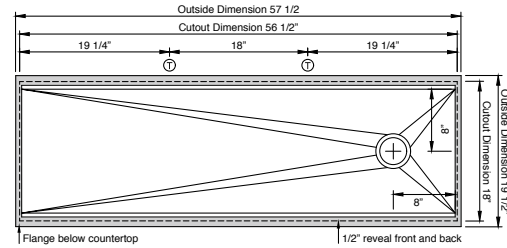

Center Galley Tap holes 2" from the back of the 18" countertop cutout

Customize Your Galley

Add 7-12" length	\$1,200	p. 80	9" depth	\$300	p. 80
Add 1-6" length	\$900	p. 80	Center drain	\$300	p. 80
Add 18" DryDock	\$1,800	p. 79	ThinTop™	\$500	p. 79
Add 12" DryDock	\$1,500	p. 79	WorkTop™	Custom	p. 79
Apron front	\$2,500	p. 79	*Color coded labels available		p. 87

For Galley Tap Suite see pages 93-112
For Freight see page 117

Recommended Basin Accessories & citrine.

Bottom Grate set BG-5-S-2-SS Stainless Steel

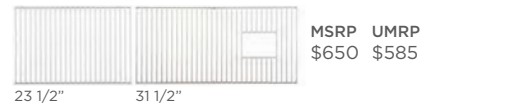

CIT-09-SS-C



CIT-09-WD-C



CIT-04-WD-B

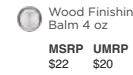

Strainer M-DRN-MSS Angel Finish 304 Stainless Steel



Disposal Strainer G-DRN-MSS Angel Finish 304 Stainless Steel



Auto Strainer Angel Finish 304 Stainless Steel with Polished or Matte knob



A-DRN-MSS shown

Ideal Workstation. 4S

IWS-4-S-WA MSRP \$5,295 UMRP \$4,766



American Black Walnut

IWS-4-S-GT MSRP \$4,895 UMRP \$4,406



Graphite Wood Composite

IWS-4-S-BA MSRP \$4,895 UMRP \$4,406



Natural Golden Bamboo

IWS-4-S-GR MSRP \$4,595 UMRP \$4,136



Exclusive Gray Resin*

IWS-4-S-WH MSRP \$4,595 UMRP \$4,136



Designer White Resin*

Culinary Tools included (CKT-12)

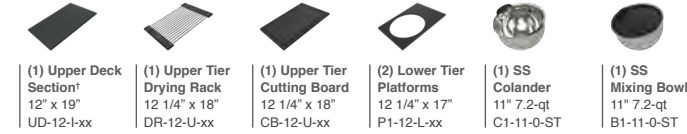

- (1) Upper Deck Section† 12" x 19" UD-12-l-xx
- (1) Upper Tier Drying Rack 12 1/4" x 18" DR-12-U-xx
- (1) Upper Tier Cutting Board 12 1/4" x 18" CB-12-U-xx
- (2) Lower Tier Platforms 12 1/4" x 17" P1-12-L-xx
- (1) SS Colander 11" 7.2-qt C1-11-0-ST
- (1) SS Mixing Bowl 11" 7.2-qt B1-11-0-ST

For Optional Culinary Tools see pages 85-90

† The Upper Deck requires a 1/4" clearance below the surface of the countertop. If the countertop thickness is 3/4" or less, Walnut or Bamboo Upper Deck sections will not have the clearance to function above the Upper Tier Culinary Tools.

Upper Deck.

Cover set UD-4-2P-WA/GT/BA/GR/WH Walnut, Graphite, Bamboo, Gray or White Resin

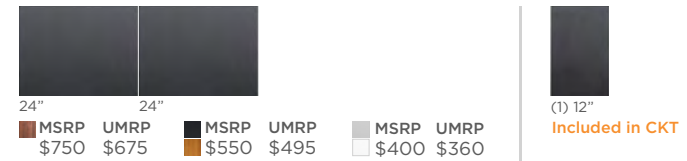

Sections Walnut, Graphite, Bamboo, Gray or White Resin



Specifications

Single bowl
Users: 1
Culinary Tools included: Five
Galley Tap recommended: One
Outside dimensions: 45 1/2" x 19 1/2" x 10 5/16"
Interior dimensions: 44" x 17" x 10"
Countertop cutout: 44 1/2" x 18"
Basin area: 44" x 16"
Minimum cabinet size: 48" or 120cm

Basin (KSO-4-S-SS)

16GA 316L stainless steel indoor/outdoor
SilentArmor™ sound reduction technology
Angel finish
Three tier design
Star™ groove pattern
Reversible side drain
Drain cover included
Limited Lifetime Warranty
Made in the USA
ASME A112.19.3/CSA B45.4 certified
cUPC™ certified

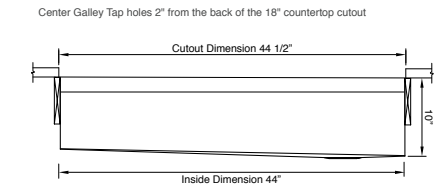
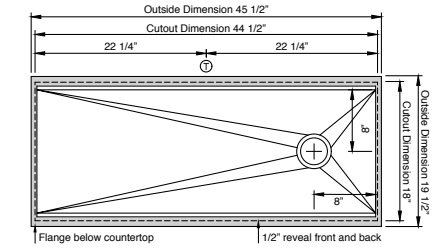

Center Galley Tap holes 2" from the back of the 18" countertop cutout

Customize Your Galley

Add 7-12" length	\$1,200	p. 80	9" depth	\$300	p. 80
Add 1-6" length	\$900	p. 80	Center drain	\$300	p. 80
Add 18" DryDock	\$1,800	p. 79	ThinTop™	\$500	p. 79
Add 12" DryDock	\$1,500	p. 79	WorkTop™	Custom	p. 79
Apron front	\$2,300	p. 79	*Color coded labels available		p. 87

For Galley Tap Suite see pages 93-112
For Freight see page 117

Recommended Basin Accessories & citrine.

Bottom Grate set BG-4-S-2-SS Stainless Steel



CIT-09-SS-C



CIT-09-WD-C



CIT-04-WD-B

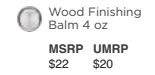

Strainer M-DRN-MSS Angel Finish 304 Stainless Steel



Disposal Strainer G-DRN-MSS Angel Finish 304 Stainless Steel



Auto Strainer Angel Finish 304 Stainless Steel with Polished or Matte knob

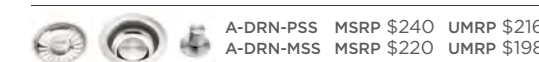

A-DRN-MSS shown

Ideal Workstation. 3S

IWS-3-S-WA



MSRP \$4,295
UMRP \$3,866

IWS-3-S-GT



MSRP \$3,895
UMRP \$3,506

IWS-3-S-BA



MSRP \$3,895
UMRP \$3,506

IWS-3-S-GR



MSRP \$3,595
UMRP \$3,236

IWS-3-S-WH



MSRP \$3,595
UMRP \$3,236

Culinary Tools included (CKT-12)

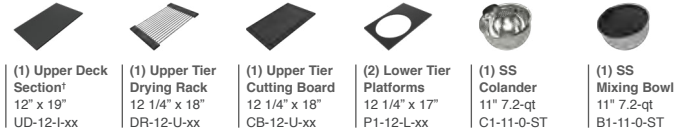

For Optional Culinary Tools see pages 85-90

† The Upper Deck requires a 1/4" clearance below the surface of the countertop. If the countertop thickness is 3/4" or less, Walnut or Bamboo Upper Deck sections will not have the clearance to function above the Upper Tier Culinary Tools.

Upper Deck.

Cover set UD-3-2P-WA/GT/BA/GR/WH Walnut, Graphite, Bamboo, Gray or White Resin

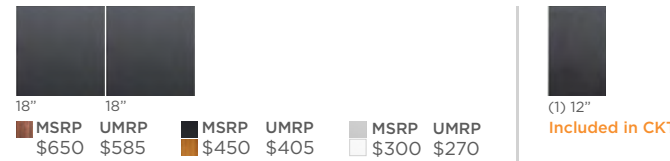

Sections Walnut, Graphite, Bamboo, Gray or White Resin

Upper Deck Sections			
UD-18-I	MSRP \$325	UMRP \$293	WA
UD-12-I	MSRP \$225	UMRP \$203	GT/BA
UD-09-I	MSRP \$225	UMRP \$203	GT/BA
UD-06-I	MSRP \$150	UMRP \$135	GR/WH
UD-09-I	MSRP \$275	UMRP \$248	WA
UD-06-I	MSRP \$175	UMRP \$158	GT/BA
UD-12-I	MSRP \$300	UMRP \$270	WA
UD-06-I	MSRP \$125	UMRP \$113	GR/WH

Specifications

Single bowl
Users: 1
Culinary Tools included: Five
Galley Tap recommended: One
Outside dimensions: 33 1/2" x 19 1/2" x 10 5/16"
Interior dimensions: 32" x 17" x 10"
Countertop cutout: 32 1/2" x 18"
Basin area: 32" x 16"
Minimum cabinet size: 36" or 90cm

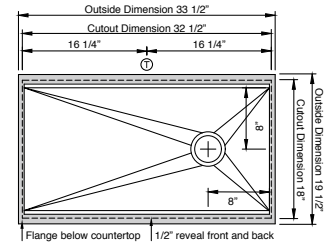

Center Galley Tap holes 2" from the back of the 18" countertop cutout

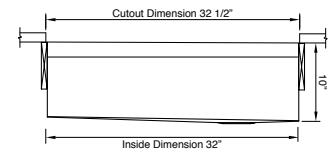

Basin (KSO-3-S-SS)

16GA 316L stainless steel indoor/outdoor
SilentArmor™ sound reduction technology
Angel finish
Three tier design
Star™ groove pattern
Reversible side drain
Drain cover included
Limited Lifetime Warranty
Made in the USA
ASME A112.19.3/CSA B45.4 certified
cUPC™ certified

Customize Your Galley

Add 7-12" length	\$1,200	p. 80	9" depth	\$300	p. 80
Add 1-6" length	\$900	p. 80	Center drain	\$300	p. 80
Add 18" DryDock	\$1,800	p. 79	ThinTop™	\$500	p. 79
Add 12" DryDock	\$1,500	p. 79	WorkTop™	Custom	p. 79
Apron front	\$2,100	p. 79	*Color coded labels available		p. 87

Ideal Workstation. 30S

IWS-30-S-WA



MSRP \$3,995
UMRP \$3,596

IWS-30-S-GT



MSRP \$3,595
UMRP \$3,236

IWS-30-S-BA



MSRP \$3,595
UMRP \$3,236

IWS-30-S-GR



MSRP \$3,295
UMRP \$2,966

IWS-30-S-WH

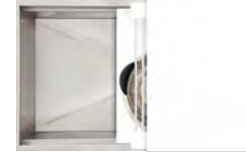

MSRP \$3,295
UMRP \$2,966

Culinary Tools included (CKT-12)

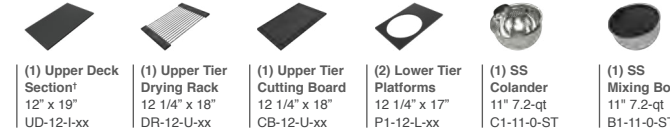

For Optional Culinary Tools see pages 85-90

† The Upper Deck requires a 1/4" clearance below the surface of the countertop. If the countertop thickness is 3/4" or less, Walnut or Bamboo Upper Deck sections will not have the clearance to function above the Upper Tier Culinary Tools.

Upper Deck.

Cover set UD-30-2P-WA/GT/BA/GR/WH Walnut, Graphite, Bamboo, Gray or White Resin

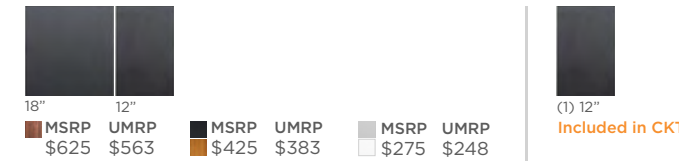

Sections Walnut, Graphite, Bamboo, Gray or White Resin

Upper Deck Sections			
UD-18-I	MSRP \$325	UMRP \$293	WA
UD-12-I	MSRP \$225	UMRP \$203	GT/BA
UD-09-I	MSRP \$225	UMRP \$203	GT/BA
UD-06-I	MSRP \$150	UMRP \$135	GR/WH
UD-09-I	MSRP \$275	UMRP \$248	WA
UD-06-I	MSRP \$175	UMRP \$158	GT/BA
UD-12-I	MSRP \$300	UMRP \$270	WA
UD-06-I	MSRP \$125	UMRP \$113	GR/WH

Specifications

Single bowl
Users: 1
Culinary Tools included: Five
Galley BarTap™ recommended: One
Outside dimensions: 27 1/2" x 19 1/2" x 10 5/16"
Interior dimensions: 26" x 17" x 10"
Countertop cutout: 26 1/2" x 18"
Basin area: 26" x 16"
Minimum cabinet size: 30" or 76cm

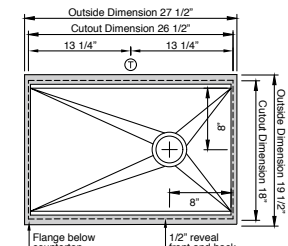

Center Galley Tap holes 2" from the back of the 18" countertop cutout

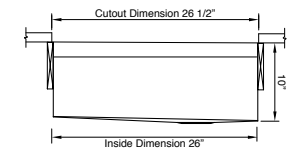

Basin (KSO-30-S-SS)

16GA 316L stainless steel indoor/outdoor
SilentArmor™ sound reduction technology
Angel finish
Three tier design
Star™ groove pattern
Reversible side drain
Drain cover included
Limited Lifetime Warranty
Made in the USA
ASME A112.19.3/CSA B45.4 certified
cUPC™ certified

Customize Your Galley

Add 7-12" length	\$1,200	p. 80	9" depth	\$300	p. 80
Add 1-6" length	\$900	p. 80	Center drain	\$300	p. 80
Add 18" DryDock	\$1,800	p. 79	ThinTop™	\$500	p. 79
Add 12" DryDock	\$1,500	p. 79	WorkTop™	Custom	p. 79
Apron front	\$2,000	p. 79	*Color coded labels available		p. 87

Ideal Workstation. 2C

IWS-2-C-WA



American Black Walnut

MSRP \$3,695
UMRP \$3,326

IWS-2-C-GT



Graphite Wood Composite

MSRP \$3,295
UMRP \$2,966

IWS-2-C-BA



Natural Golden Bamboo

MSRP \$3,295
UMRP \$2,966

IWS-2-C-GR



Exclusive Gray Resin*

MSRP \$2,995
UMRP \$2,696

IWS-2-C-WH

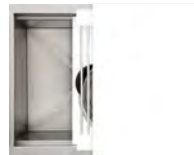

Designer White Resin*

MSRP \$2,995
UMRP \$2,696

Specifications

Single bowl
Users: 1
Culinary Tools included: Five
Galley BarTap® recommended: One
Outside dimensions: 22" x 19 1/2" x 10 5/16"
Interior dimensions: 20 1/2" x 17" x 10"
Countertop cutout: 21" x 18"
Basin area: 20 1/2" x 16"
Minimum cabinet size: 24" or 60cm

Basin (KSO-2-C-SS)

16GA 316L stainless steel indoor/outdoor
SilentArmor™ sound reduction technology
Angel finish
Three tier design
Star™ groove pattern
Center drain
Drain cover included
Limited Lifetime Warranty
Made in the USA
ASME A112.19.3/CSA B45.4 certified
cUPC™ certified

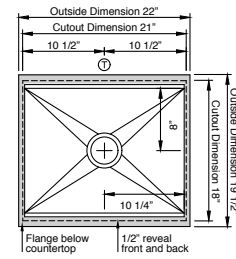

Center Galley Tap holes 2" from the back of the 18" countertop cutout

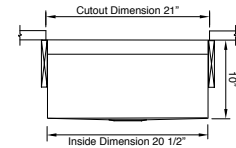

Customize Your Galley

Add 7-12" length	\$1,200	p. 80	9" depth	\$300	p. 80
Add 1-6" length	\$900	p. 80	ThinTop™	\$500	p. 79
Add 18" DryDock	\$1,800	p. 79	WorkTop™	Custom	p. 79
Add 12" DryDock	\$1,500	p. 79	*Color coded labels available		p. 87
Apron front	\$1,900	p. 79			

Culinary Tools included (CKT-12)

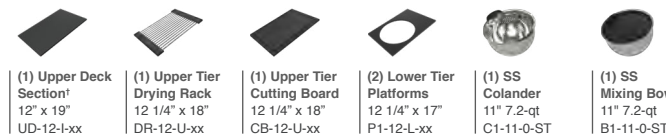

(1) Upper Deck Section† 12" x 19" UD-12-l-xx	(1) Upper Tier Drying Rack 12 1/4" x 18" DR-12-U-xx	(1) Upper Tier Cutting Board 12 1/4" x 18" CB-12-U-xx	(2) Lower Tier Platforms 12 1/4" x 17" P1-12-L-xx	(1) SS Colander 11" 7.2-qt C1-11-0-ST	(1) SS Mixing Bowl 11" 7.2-qt B1-11-0-ST
--	---	---	---	---	--

For Optional Culinary Tools see pages 85-90

† The Upper Deck requires a 1/4" clearance below the surface of the countertop. If the countertop thickness is 3/4" or less, Walnut or Bamboo Upper Deck sections will not have the clearance to function above the Upper Tier Culinary Tools.

Upper Deck.

Cover set UD-2-2P-WA/GT/BA/GR/WH Walnut, Graphite, Bamboo, Gray or White Resin

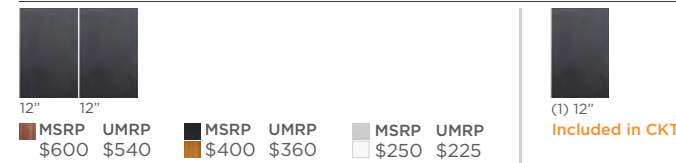

Sections Walnut, Graphite, Bamboo, Gray or White Resin

Section	MSRP	UMRP
UD-12-l	\$600	\$540
UD-06-l	\$275	\$248

Upper Deck Sections	MSRP	UMRP
UD-12-l	\$300	\$270
WA	\$300	\$270
GT/BA	\$200	\$180
GR/WH	\$125	\$113

Recommended Basin Accessories & citrine.

Bottom Grate set BG-2-C-1-SS Stainless Steel

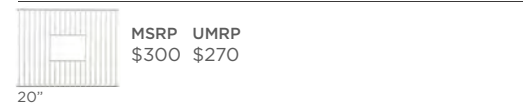

MSRP \$300
UMRP \$270

Strainer M-DRN-MSS
Angel Finish 304 Stainless Steel



MSRP \$110
UMRP \$99

Disposal Strainer G-DRN-MSS
Angel Finish 304 Stainless Steel



MSRP \$110
UMRP \$99

Auto Strainer Angel Finish 304 Stainless Steel with Polished or Matte knob



A-DRN-PSS MSRP \$240 UMRP \$216
A-DRN-MSS MSRP \$220 UMRP \$198

CIT-09-SS-C



Stainless Steel Clean + Polish 9 oz
MSRP \$33
UMRP \$30

CIT-09-WD-C



Wood Condition + Protect 9 oz
MSRP \$25
UMRP \$23

CIT-04-WD-B

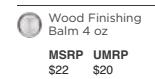

Wood Finishing Balm 4 oz
MSRP \$22
UMRP \$20

American Black Walnut

3/4" Natural Material
Classic solid wood finish
Hand-selected Walnut
Gentle on knives
Sanitary, dense, non-porous
Care for with citrine.
Eco-friendly

Natural Golden Bamboo

3/4" Natural Material
Traditional solid wood finish
Hand-selected Bamboo
Gentle on knives
Sanitary, dense, non-porous
Care for with citrine.
Eco-friendly

Materials & Finishes

Graphite Wood Composite

1/2" High Performance Material
Modern, off-black, matte finish
Gentle on knives
Sanitary, non-porous, NSF certified
Dishwasher safe
Heat resistant up to 350°F
Eco-friendly
Indoor/Outdoor, UV rated
Write on with soapstone chalk!

Exclusive Gray Resin Designer White Resin

5/8" Material
Transitional finishes
Gentle on knives
Sanitary, non-porous, NSF certified
Dishwasher safe
Heat resistant up to 212°F
Indoor/Outdoor, UV rated
Color coded labeling available



Ideal Corner Workstation 4X4C, Ideal WashStation™ 30S with Graphite Wood Composite / Graphite Resin+ Kits, Walnut Corner Chef's Block, PVD Satin Black Taps, Hot & Cold Tap, Soap Dispensers, and Deck Switches

Functionality is just around the corner

Transform space that is traditionally a non-functional area within the kitchen into an incredibly efficient and useful inside corner. Have twice the fun by creating a two person Workstation on an outside corner.

Get the most out of every corner in your kitchen



IDEAL CORNER WORKSTATIONS

IWS-4X4-C

MEDIUM

Five Single Tier Culinary Tools

- Outside Corner
- Inside Corner



IWS-4X3-C

SMALL

Five Single Tier Culinary Tools

- Outside Corner
- Inside Corner



IWS-3X4-C

SMALL

Five Single Tier Culinary Tools

- Outside Corner
- Inside Corner



Ideal Corner Workstation 4X4C

IWS-4X4-C-WA

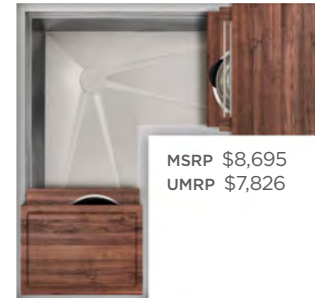

MSRP \$8,695
UMRP \$7,826

American Black Walnut

IWS-4X4-C-GT



MSRP \$8,295
UMRP \$7,466

Graphite Wood Composite

IWS-4X4-C-BA



MSRP \$8,295
UMRP \$7,466

Natural Golden Bamboo

IWS-4X4-C-GR



MSRP \$7,995
UMRP \$7,196

Exclusive Gray Resin*

IWS-4X4-C-WH



MSRP \$7,995
UMRP \$7,196

Designer White Resin*

Specifications

Single bowl
Users: 2 (Outside Corner), 1 (Inside Corner)
Culinary Tools included: Five
Galley Tap(s) recommended:
Two (Outside Corner), One (Inside Corner)
Outside dimensions: 44" x 44" x 19 1/2" x 10 5/16"
Interior dimensions: 42" x 42" x 17" x 10"
Countertop cutout: 42 3/4" x 42 3/4" x 18"
Basin area: 42" x 42" x 16"
Min. cabinet size: 48" x 48" or 120cm x 120cm

Basin (KSO-4X4-C-SS)

16GA 316L stainless steel indoor/outdoor
SilentArmor™ sound reduction technology
Angel finish
Three tier design
Star™ groove pattern
Side drain
Drain cover included
Limited Lifetime Warranty
Made in the USA
ASME A112.19.3/CSA B45.4 certified
cUPC™ certified

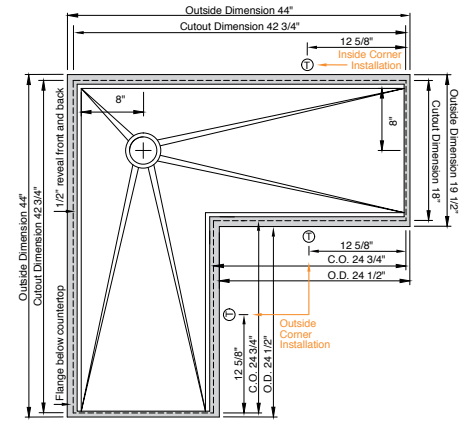

Center Galley Tap holes 2" from the back of the 18" countertop cutout

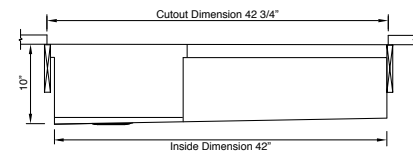

Culinary Tools included (CKT-12)

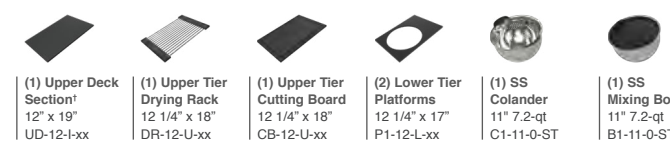

For Optional Culinary Tools see pages 85-90

* The Upper Deck requires a 1/4" clearance below the surface of the countertop. If the countertop thickness is 3/4" or less, Walnut or Bamboo Upper Deck sections will not have the clearance to function above the Upper Tier Culinary Tools.

Upper Deck.

Cover set UD-4X4-3P-WA/GT/BA/GR/WH Walnut, Graphite, Bamboo, Gray or White Resin

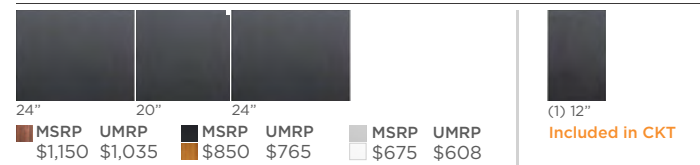

Sections Walnut, Graphite, Bamboo, Gray or White Resin

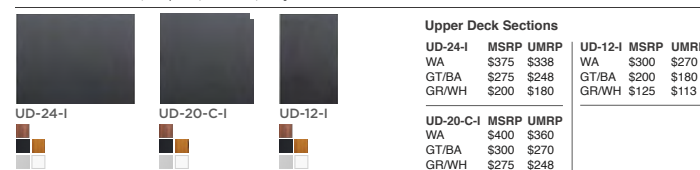

Ideal Corner Workstation 4X3C

IWS-4X3-C-WA



MSRP \$7,695
UMRP \$6,926

American Black Walnut

IWS-4X3-C-GT



MSRP \$7,295
UMRP \$6,566

Graphite Wood Composite

IWS-4X3-C-BA



MSRP \$7,295
UMRP \$6,566

Natural Golden Bamboo

IWS-4X3-C-GR



MSRP \$6,995
UMRP \$6,296

Exclusive Gray Resin*

IWS-4X3-C-WH



MSRP \$6,995
UMRP \$6,296

Designer White Resin*

Specifications

Single bowl
Users: 2 (Outside Corner), 1 (Inside Corner)
Culinary Tools included: Five
Galley Tap recommended: One
Outside dimensions: 44" x 32" x 19 1/2" x 10 5/16"
Interior dimensions: 42" x 30" x 17" x 10"
Countertop cutout: 42 3/4" x 30 3/4" x 18"
Basin area: 42" x 30" x 16"
Min. cabinet size: 48" x 36" or 120cm x 90cm

Basin (KSO-4X3-C-SS)

16GA 316L stainless steel indoor/outdoor
SilentArmor™ sound reduction technology
Angel finish
Three tier design
Star™ groove pattern
Side drain
Drain cover included
Limited Lifetime Warranty
Made in the USA
ASME A112.19.3/CSA B45.4 certified
cUPC™ certified

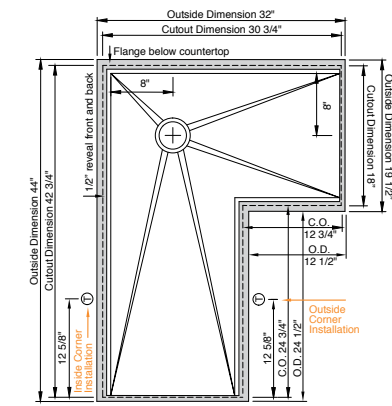

Center Galley Tap holes 2" from the back of the 18" countertop cutout

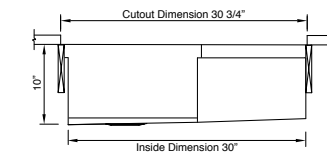

Culinary Tools included (CKT-12)

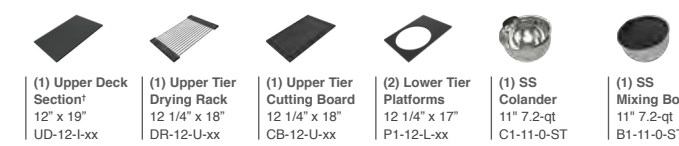

For Optional Culinary Tools see pages 85-90

* The Upper Deck requires a 1/4" clearance below the surface of the countertop. If the countertop thickness is 3/4" or less, Walnut or Bamboo Upper Deck sections will not have the clearance to function above the Upper Tier Culinary Tools.

Upper Deck.

Cover set UD-4X3-3P-WA/GT/BA/GR/WH Walnut, Graphite, Bamboo, Gray or White Resin

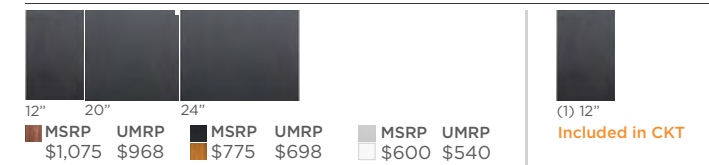

Sections Walnut, Graphite, Bamboo, Gray or White Resin

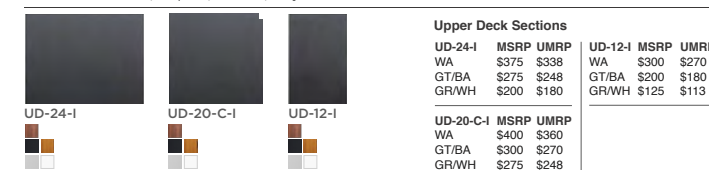

Customize Your Galley

Add 7-12" length	\$1,200	p. 80	9" depth	\$300	p. 80
Add 1-6" length	\$900	p. 79	ThinTop™	\$500	p. 79
Add 18" DryDock	\$1,800	p. 79	WorkTop™	Custom	p. 79
Add 12" DryDock	\$1,500	p. 79	*Color coded labels available		p. 87

For Galley Tap Suite see pages 93-112
For Freight see page 117

Recommended Basin Accessories & citrine.

Bottom Grate set BG-4X4-C-3-SS Stainless Steel

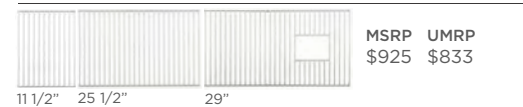

CIT-09-SS-C



CIT-09-WD-C



CIT-04-WD-B

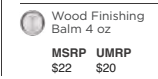

Strainer M-DRN-MSS
Angel Finish 304 Stainless Steel



Disposal Strainer G-DRN-MSS
Angel Finish 304 Stainless Steel

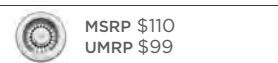

Auto Strainer Angel Finish 304 Stainless Steel with Polished or Matte knob



A-DRN-MSS shown

Customize Your Galley

Add 7-12" length	\$1,200	p. 80	9" depth	\$300	p. 80
Add 1-6" length	\$900	p. 80	ThinTop™	\$500	p. 79
Add 18" DryDock	\$1,800	p. 79	WorkTop™	Custom	p. 79
Add 12" DryDock	\$1,500	p. 79	*Color coded labels available		p. 87

For Galley Tap Suite see pages 93-112
For Freight see page 117

Recommended Basin Accessories & citrine.

Bottom Grate set BG-4X3-C-3-SS Stainless Steel

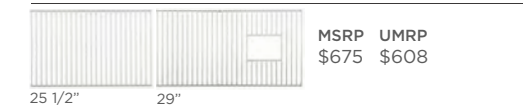

CIT-09-SS-C



CIT-09-WD-C



CIT-04-WD-B

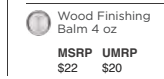

Strainer M-DRN-MSS
Angel Finish 304 Stainless Steel



Disposal Strainer G-DRN-MSS
Angel Finish 304 Stainless Steel

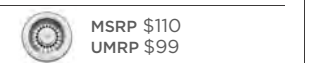

Auto Strainer Angel Finish 304 Stainless Steel with Polished or Matte knob



A-DRN-MSS shown



Ideal WashStation™ 3S with Designer White Resin / Resin+ Wash Kit, PVD Brushed Gold Stainless Steel Tap, Soap Dispenser, and Deck Switch

Keep it clean and simple

Clean up is made easy with all of the right tools. The Galley WashStation™ makes the kitchen more functional when added to the Galley Workstation. All preparation, cooking, serving and entertaining happens at the Workstation and cleaning happens at the WashStation. Get the most out of your kitchen with a Workstation + WashStation.

Get in the "Wash" Zone



IDEAL WASHSTATIONS™

IWA-4-D Four Single Tier Wash Tools
X-LARGE 



IWA-4-S Four Single Tier Wash Tools
X-LARGE 



IWA-3-S Four Single Tier Wash Tools
LARGE 



IWA-30-S Four Single Tier Wash Tools
MEDIUM 



IWA-2-C Four Single Tier Wash Tools
SMALL 



Ideal WashStation™ 4D

IWA-4-D-WA



MSRP \$6,095
UMRP \$5,486

American Black Walnut / Graphite Resin+

IWA-4-D-GT



MSRP \$5,995
UMRP \$5,396

Graphite Wood Composite / Graphite Resin+

IWA-4-D-BA



MSRP \$5,995
UMRP \$5,396

Natural Golden Bamboo / Exclusive Gray Resin+

IWA-4-D-GR



MSRP \$5,895
UMRP \$5,306

Exclusive Gray Resin* / Resin+

IWA-4-D-WH



MSRP \$5,895
UMRP \$5,306

Designer White Resin* / Resin+

Wash Tools included (WKT-4T)



- (1) Upper Tier Drying Rack 9 1/4" x 18" DR-09-U-xx
- (1) Lower Tier Wash Caddy 6" x 17" WC-06-L-xx
- (1) Lower Tier Wash Bowl 12" x 17" WB-12-L-xx
- (1) Upper Tier Utensil Caddy 6" x 18" UC-06-U-xx

For Optional Culinary Tools see pages 85-90

Upper Deck.

Cover set UD-4-2P-WA/GT/BA/GR/WH Walnut, Graphite, Bamboo, Gray or White Resin



MSRP UMRP
\$750 \$675

MSRP UMRP
\$550 \$495

MSRP UMRP
\$400 \$360

Sections Walnut, Graphite, Bamboo, Gray or White Resin

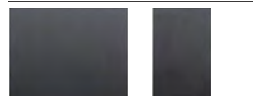

Upper Deck Sections

UD-24-I	MSRP \$300	UMRP \$270
WA	\$375	\$338
GT/BA	\$275	\$248
GR/WH	\$200	\$180

UD-12-I

MSRP \$300	UMRP \$270
GT/BA \$200	\$180
GR/WH \$125	\$113

Specifications

Double bowl
Users: 1
Wash Tools included: Four
Galley Tap recommended: One
Outside dimensions: 45 1/2" x 19 1/2" x 10 5/16"
Interior dimensions: 44" x 17" x 10"
Countertop cutout: 44 1/2" x 18"
Basin area: 21 7/8", 21 7/8" x 16"
Minimum cabinet size: 48" or 120cm

Basin (KSO-4-D-SS)

16GA 316L stainless steel indoor/outdoor
SilentArmor™ sound reduction technology
Angel finish
Three tier design
Star™ groove pattern
Center drains
Drain covers included
Limited Lifetime Warranty
Made in the USA
ASME A112.19.3/CSA B45.4 certified
cUPC™ certified

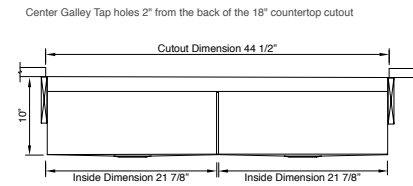
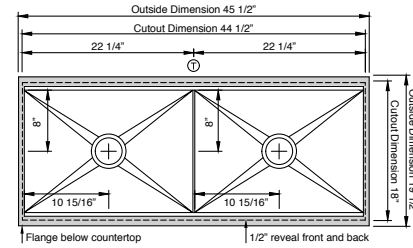

Customize Your Galley

Add 7-12" length	\$1,200	p. 80	9" depth	\$300	p. 80
Add 1-6" length	\$900	p. 80	ThinTop™	\$500	p. 79
Add 18" DryDock	\$1,800	p. 79	WorkTop™	Custom	p. 79
Add 12" DryDock	\$1,500	p. 79	Color coded labels available		p. 87
Apron front	\$2,300	p. 79			

For Galley Tap Suite see pages 93-112
For Freight see page 117

Recommended Basin Accessories & citrine.

Bottom Grate set BG-4-D-2-SS Stainless Steel

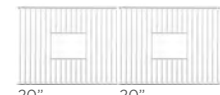

MSRP UMRP
\$600 \$540

Strainer M-DRN-MSS
Angel Finish 304 Stainless Steel



Disposal Strainer G-DRN-MSS
Angel Finish 304 Stainless Steel



Auto Strainer Angel Finish 304 Stainless Steel with Polished or Matte knob



A-DRN-PSS MSRP \$240 UMRP \$216
A-DRN-MSS MSRP \$220 UMRP \$198

CIT-09-SS-C



Stainless Steel
Clean + Polish 9 oz
MSRP UMRP
\$33 \$30

CIT-09-WD-C



Wood Condition
+ Protect 9 oz
MSRP UMRP
\$25 \$23

CIT-04-WD-B

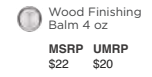

Wood Finishing
Balm 4 oz
MSRP UMRP
\$22 \$20

Ideal WashStation™ 4S

IWA-4-S-WA



MSRP \$4,695
UMRP \$4,226

American Black Walnut / Graphite Resin+

IWA-4-S-GT



MSRP \$4,595
UMRP \$4,136

Graphite Wood Composite / Graphite Resin+

IWA-4-S-BA



MSRP \$4,595
UMRP \$4,136

Natural Golden Bamboo / Exclusive Gray Resin+

IWA-4-S-GR



MSRP \$4,495
UMRP \$4,046

Exclusive Gray Resin* / Resin+

IWA-4-S-WH



MSRP \$4,495
UMRP \$4,046

Designer White Resin* / Resin+

Wash Tools included (WKT-4T)



- (1) Upper Tier Drying Rack 9 1/4" x 18" DR-09-U-xx
- (1) Lower Tier Wash Caddy 6" x 17" WC-06-L-xx
- (1) Lower Tier Wash Bowl 12" x 17" WB-12-L-xx
- (1) Upper Tier Utensil Caddy 6" x 18" UC-06-U-xx

For Optional Culinary Tools see pages 85-90

Upper Deck.

Cover set UD-4-2P-WA/GT/BA/GR/WH Walnut, Graphite, Bamboo, Gray or White Resin

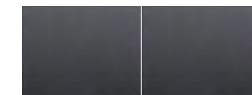

MSRP UMRP
\$750 \$675

MSRP UMRP
\$550 \$495

MSRP UMRP
\$400 \$360

Sections Walnut, Graphite, Bamboo, Gray or White Resin

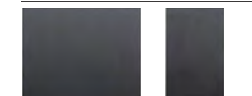

Upper Deck Sections

UD-24-I	MSRP \$300	UMRP \$270
WA	\$375	\$338
GT/BA	\$275	\$248
GR/WH	\$200	\$180

UD-12-I

MSRP \$300	UMRP \$270
GT/BA \$200	\$180
GR/WH \$125	\$113

Specifications

Single bowl
Users: 1
Wash Tools included: Four
Galley Tap recommended: One
Outside dimensions: 45 1/2" x 19 1/2" x 10 5/16"
Interior dimensions: 44" x 17" x 10"
Countertop cutout: 44 1/2" x 18"
Basin area: 44" x 16"
Minimum cabinet size: 48" or 120cm

Basin (KSO-4-S-SS)

16GA 316L stainless steel indoor/outdoor
SilentArmor™ sound reduction technology
Angel finish
Three tier design
Star™ groove pattern
Reversible side drain
Drain cover included
Limited Lifetime Warranty
Made in the USA
ASME A112.19.3/CSA B45.4 certified
cUPC™ certified

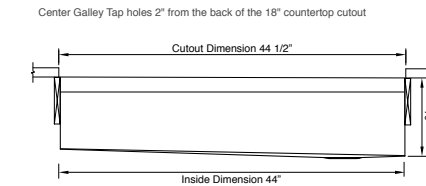
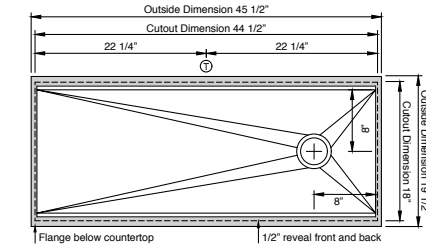

Customize Your Galley

Add 7-12" length	\$1,200	p. 80	9" depth	\$300	p. 80
Add 1-6" length	\$900	p. 80	Center drain	\$300	p. 80
Add 18" DryDock	\$1,800	p. 79	ThinTop™	\$500	p. 79
Add 12" DryDock	\$1,500	p. 79	WorkTop™	Custom	p. 79
Apron front	\$2,300	p. 79	Color coded labels available		p. 87

For Galley Tap Suite see pages 93-112
For Freight see page 117

Recommended Basin Accessories & citrine.

Bottom Grate set BG-4-S-2-SS Stainless Steel



MSRP UMRP
\$600 \$540

Strainer M-DRN-MSS
Angel Finish 304 Stainless Steel



Disposal Strainer G-DRN-MSS
Angel Finish 304 Stainless Steel



Auto Strainer Angel Finish 304 Stainless Steel with Polished or Matte knob



A-DRN-PSS MSRP \$240 UMRP \$216
A-DRN-MSS MSRP \$220 UMRP \$198

CIT-09-SS-C

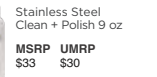

Stainless Steel
Clean + Polish 9 oz
MSRP UMRP
\$33 \$30

CIT-09-WD-C



Wood Condition
+ Protect 9 oz
MSRP UMRP
\$25 \$23

CIT-04-WD-B

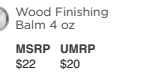

Wood Finishing
Balm 4 oz
MSRP UMRP
\$22 \$20

Ideal WashStation™ 3S

IWA-3-S-WA



MSRP \$3,695
UMRP \$3,326

American Black Walnut / Graphite Resin+

IWA-3-S-GT

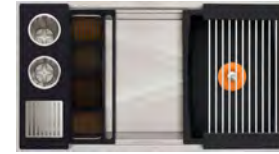

MSRP \$3,595
UMRP \$3,236

Graphite Wood Composite / Graphite Resin+

IWA-3-S-BA

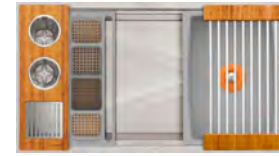

MSRP \$3,595
UMRP \$3,236

Natural Golden Bamboo / Exclusive Gray Resin+

IWA-3-S-GR

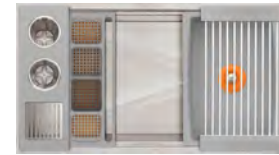

MSRP \$3,495
UMRP \$3,146

Exclusive Gray Resin+ / Resin+

IWA-3-S-WH

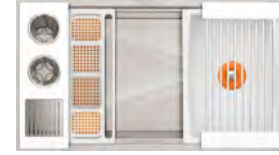

MSRP \$3,495
UMRP \$3,146

Designer White Resin+ / Resin+

Wash Tools included (WKT-4T)



(1) Upper Tier Drying Rack 9 1/4" x 18" DR-09-U-xx	(1) Lower Tier Wash Caddy 6" x 17" WC-06-L-xx	(1) Lower Tier Wash Bowl 12" x 17" WB-12-L-xx	(1) Upper Tier Utensil Caddy 6" x 18" UC-06-U-xx
--	---	---	--

For Optional Culinary Tools see pages 85-90

Upper Deck.

Cover set UD-3-2P-WA/GT/BA/GR/WH Walnut, Graphite, Bamboo, Gray or White Resin

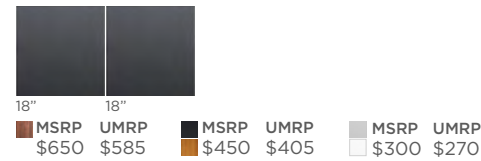

Sections Walnut, Graphite, Bamboo, Gray or White Resin



Upper Deck Sections
UD-18-I MSRP UMRP
WA \$325 \$293
GT/BA \$225 \$203
GR/WH \$150 \$135

UD-09-I MSRP UMRP
WA \$275 \$248
GT/BA \$175 \$158
GR/WH \$100 \$90

Specifications

Single bowl
Users: 1
Wash Tools included: Four
Galley Tap recommended: One
Outside dimensions: 33 1/2" x 19 1/2" x 10 5/16"
Interior dimensions: 32" x 17" x 10"
Countertop cutout: 32 1/2" x 18"
Basin area: 32" x 16"
Minimum cabinet size: 36" or 90cm

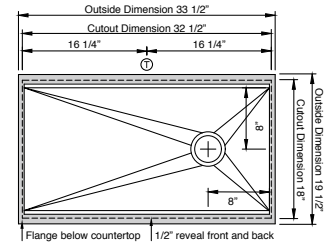

Center Galley Tap holes 2" from the back of the 18" countertop cutout

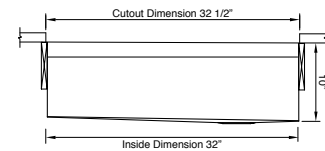

Basin (KSO-3-S-SS)

16GA 316L stainless steel indoor/outdoor
SilentArmor™ sound reduction technology
Angel finish
Three tier design
Star™ groove pattern
Reversible side drain
Drain cover included
Limited Lifetime Warranty
Made in the USA
ASME A112.19.3/CSA B45.4 certified
cUPC™ certified

Customize Your Galley

Add 7-12" length	\$1,200	p. 80	9" depth	\$300	p. 80
Add 1-6" length	\$900	p. 80	Center drain	\$300	p. 80
Add 18" DryDock	\$1,800	p. 79	ThinTop™	\$500	p. 79
Add 12" DryDock	\$1,500	p. 79	WorkTop™	Custom	p. 79
Apron front	\$2,100	p. 79	*Color coded labels available		p. 87

For Galley Tap Suite see pages 93-112
For Freight see page 117

Recommended Basin Accessories & citrine.

Bottom Grate set BG-3-S-1-SS Stainless Steel



MSRP UMRP
\$350 \$315

Strainer M-DRN-MSS
Angel Finish 304 Stainless Steel



MSRP \$110
UMRP \$99

Disposal Strainer G-DRN-MSS
Angel Finish 304 Stainless Steel



MSRP \$110
UMRP \$99

Auto Strainer Angel Finish 304 Stainless Steel with Polished or Matte knob



A-DRN-MSS shown

CIT-09-SS-C
Stainless Steel
Clean + Polish 9 oz



MSRP UMRP
\$33 \$30

CIT-09-WD-C
Wood Condition
+ Protect 9 oz



MSRP UMRP
\$25 \$23

CIT-04-WD-B
Wood Finishing
Balm 4 oz

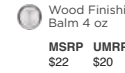

MSRP UMRP
\$22 \$20

Ideal WashStation™ 30S

IWA-30-S-WA



MSRP \$3,395
UMRP \$3,056

American Black Walnut / Graphite Resin+

IWA-30-S-GT



MSRP \$3,295
UMRP \$2,966

Graphite Wood Composite / Graphite Resin+

IWA-30-S-BA

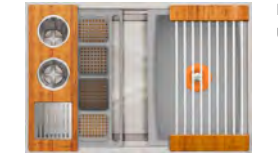

MSRP \$3,295
UMRP \$2,966

Natural Golden Bamboo / Gray Resin+

IWA-30-S-GR



MSRP \$3,195
UMRP \$2,876

Exclusive Gray Resin+ / Resin+

IWA-30-S-WH

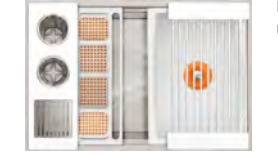

MSRP \$3,195
UMRP \$2,876

Designer White Resin+ / Resin+

Wash Tools included (WKT-4T)



(1) Upper Tier Drying Rack 9 1/4" x 18" DR-09-U-xx	(1) Lower Tier Wash Caddy 6" x 17" WC-06-L-xx	(1) Lower Tier Wash Bowl 12" x 17" WB-12-L-xx	(1) Upper Tier Utensil Caddy 6" x 18" UC-06-U-xx
--	---	---	--

For Optional Culinary Tools see pages 85-90

Upper Deck.

Cover set UD-30-2P-WA/GT/BA/GR/WH Walnut, Graphite, Bamboo, Gray or White Resin

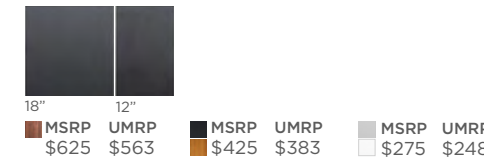

Sections Walnut, Graphite, Bamboo, Gray or White Resin



Upper Deck Sections
UD-18-I MSRP UMRP
WA \$300 \$270
GT/BA \$225 \$203
GR/WH \$150 \$135

UD-06-I MSRP UMRP
WA \$275 \$248
GT/BA \$175 \$158
GR/WH \$100 \$90

Specifications

Single bowl
Users: 1
Wash Tools included: Four
Galley BarTap, recommended: One
Outside dimensions: 27 1/2" x 19 1/2" x 10 5/16"
Interior dimensions: 26" x 17" x 10"
Countertop cutout: 26 1/2" x 18"
Basin area: 26" x 16"
Minimum cabinet size: 30" or 76cm

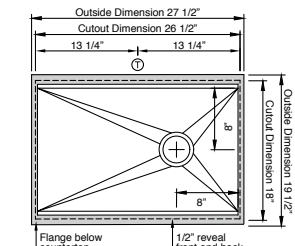

Center Galley Tap holes 2" from the back of the 18" countertop cutout

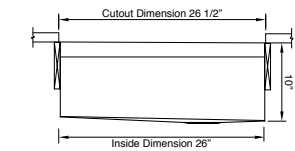

Basin (KSO-30-S-SS)

16GA 316L stainless steel indoor/outdoor
SilentArmor™ sound reduction technology
Angel finish
Three tier design
Star™ groove pattern
Reversible side drain
Drain cover included
Limited Lifetime Warranty
Made in the USA
ASME A112.19.3/CSA B45.4 certified
cUPC™ certified

Customize Your Galley

Add 7-12" length	\$1,200	p. 80	9" depth	\$300	p. 80
Add 1-6" length	\$900	p. 80	Center drain	\$300	p. 80
Add 18" DryDock	\$1,800	p. 79	ThinTop™	\$500	p. 79
Add 12" DryDock	\$1,500	p. 79	WorkTop™	Custom	p. 79
Apron front	\$2,000	p. 79	*Color coded labels available		p. 87

For Galley Tap Suite see pages 93-112
For Freight see page 117

Recommended Basin Accessories & citrine.

Bottom Grate set BG-30-S-1-SS Stainless Steel



MSRP UMRP
\$325 \$293

Strainer M-DRN-MSS
Angel Finish 304 Stainless Steel



MSRP \$110
UMRP \$99

Disposal Strainer G-DRN-MSS
Angel Finish 304 Stainless Steel



MSRP \$110
UMRP \$99

Auto Strainer Angel Finish 304 Stainless Steel with Polished or Matte knob

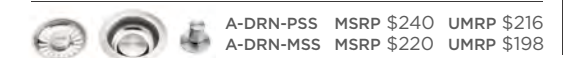

A-DRN-MSS shown

CIT-09-SS-C
Stainless Steel
Clean + Polish 9 oz

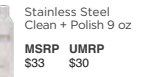

MSRP UMRP
\$33 \$30

CIT-09-WD-C
Wood Condition
+ Protect 9 oz

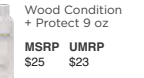

MSRP UMRP
\$25 \$23

CIT-04-WD-B
Wood Finishing
Balm 4 oz

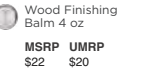

MSRP UMRP
\$22 \$20

Ideal WashStation™ 2C

IWA-2-C-WA



MSRP \$3,095
UMRP \$2,786

Black Walnut / Graphite Resin+

IWA-2-C-GT



MSRP \$2,995
UMRP \$2,696

Graphite Wood / Resin+

IWA-2-C-BA

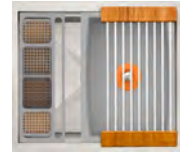

MSRP \$2,995
UMRP \$2,696

Golden Bamboo / Gray Resin+

IWA-2-C-GR



MSRP \$2,895
UMRP \$2,606

Exclusive Gray Resin+ / Resin+

IWA-2-C-WH



MSRP \$2,895
UMRP \$2,606

Designer White Resin+ / Resin+

Wash Tools included (WKT-4T)



(1) Upper Tier Drying Rack 9 1/4" x 18" DR-09-U-xx	(1) Lower Tier Wash Caddy 6" x 17" WC-06-L-xx	(1) Lower Tier Wash Bowl 12" x 17" WB-12-L-xx	(1) Upper Tier Utensil Caddy 6" x 18" UC-06-U-xx
--	---	---	--

For Optional Culinary Tools see pages 85-90

Upper Deck

Cover set UD-2-2P-WA/GT/BA/GR/WH Walnut, Graphite, Bamboo, Gray or White Resin

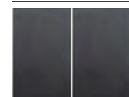

12"	12"
MSRP UMRP \$600 \$540	MSRP UMRP \$400 \$360
MSRP UMRP \$250 \$225	

Sections Walnut, Graphite, Bamboo, Gray or White Resin



Upper Deck Sections		
UD-12-I	MSRP	UMRP
WA	\$300	\$270
GT/BA	\$200	\$180
GR/WH	\$125	\$113
UD-06-I	MSRP	UMRP
WA	\$275	\$248
GT/BA	\$175	\$158
GR/WH	\$100	\$90

Specifications

Single bowl
Users: 1
Wash Tools included: Four
Galley BarTap® recommended: One
Outside dimensions: 22" x 19 1/2" x 10 5/16"
Interior dimensions: 20 1/2" x 17" x 10"
Countertop cutout: 21" x 18"
Basin area: 20 1/2" x 16"
Minimum cabinet size: 24" or 60cm

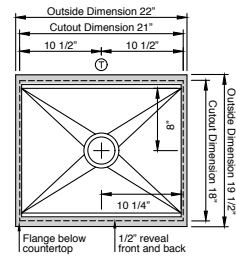

Center Galley Tap holes 2" from the back of the 18" countertop cutout

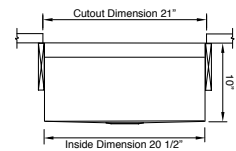

Basin (KSO-2-C-SS)

16GA 316L stainless steel indoor/outdoor
SilentArmor™ sound reduction technology
Angel finish
Three tier design
Star™ groove pattern
Center drain
Drain covers included
Limited Lifetime Warranty
Made in the USA
ASME A112.19.3/CSA B45.4 certified
cUPC™ certified

Customize Your Galley

Add 7-12" length	\$1,200	p. 80	9" depth	\$300	p. 80
Add 1-6" length	\$900	p. 80	ThinTop™	\$500	p. 79
Add 18" DryDock	\$1,800	p. 79	WorkTop™	Custom	p. 79
Add 12" DryDock	\$1,500	p. 79	*Color coded labels available		p. 87
Apron front	\$1,900	p. 79			

For Galley Tap Suite see pages 93-112
For Freight see page 117

Recommended Basin Accessories & citrine.

Bottom Grate set BG-2-C-1-SS Stainless Steel



MSRP UMRP
\$300 \$270

Strainer M-DRN-MSS
Angel Finish 304 Stainless Steel



MSRP \$110
UMRP \$99

Disposal Strainer G-DRN-MSS
Angel Finish 304 Stainless Steel



MSRP \$110
UMRP \$99

Auto Strainer Angel Finish 304 Stainless Steel with Polished or Matte knob



A-DRN-PSS MSRP \$240 UMRP \$216
A-DRN-MSS MSRP \$220 UMRP \$198

A-DRN-MSS shown

CIT-09-SS-C



Stainless Steel
Clean + Polish 9 oz
MSRP UMRP
\$33 \$30

CIT-09-WD-C



Wood Condition
+ Protect 9 oz
MSRP UMRP
\$25 \$23

CIT-04-WD-B

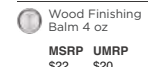

Wood Finishing
Balm 4 oz
MSRP UMRP
\$22 \$20

Resin+ Finishes

Graphite Resin+

Matte black finish
BPA/BPS-free
NSF certified
Dishwasher safe
Shatter resistant
Sanitary, non-porous
Heat & chemical resistant
Indoor/Outdoor, UV rated

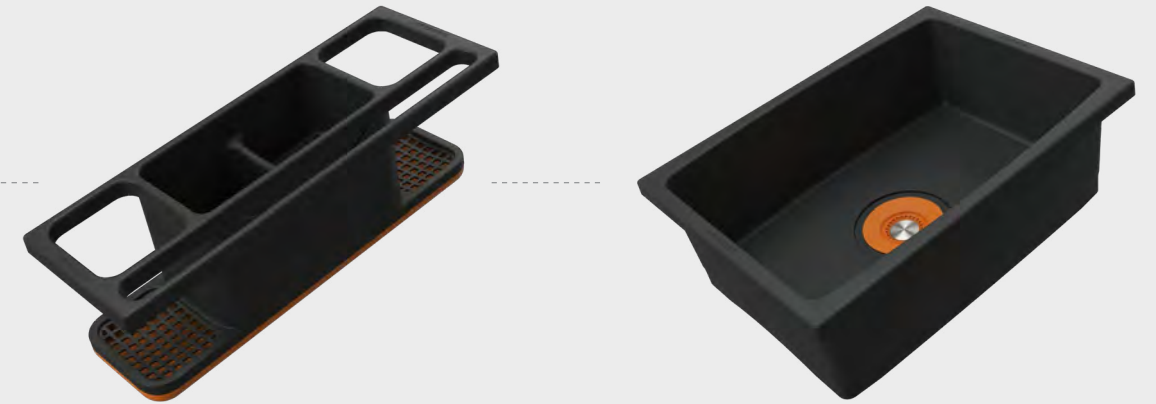

Exclusive Gray Resin+

Transitional Gray finish
BPA/BPS-free
NSF certified
Dishwasher safe
Shatter resistant
Sanitary, non-porous
Heat & chemical resistant
Indoor/Outdoor, UV rated

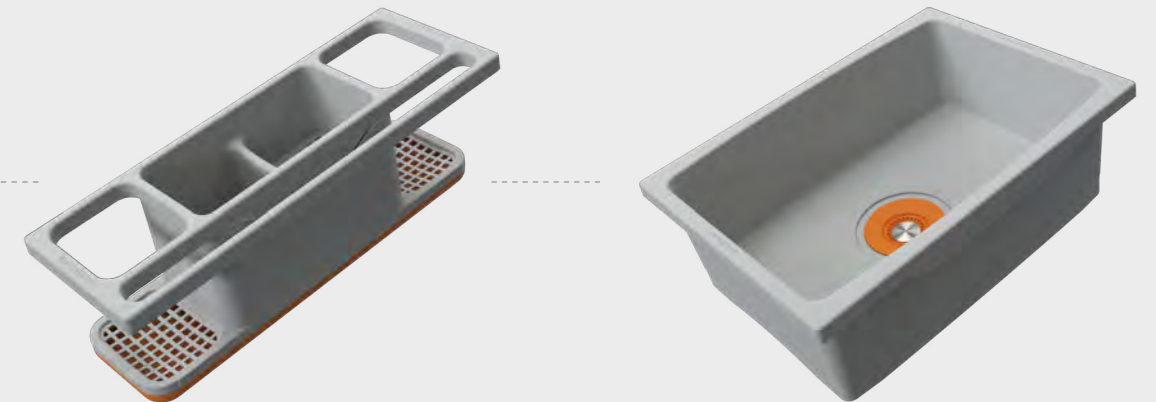

Designer White Resin+

Transitional White finish
BPA/BPS-free
NSF certified
Dishwasher safe
Shatter resistant
Sanitary, non-porous
Heat & chemical resistant
Indoor/Outdoor, UV rated

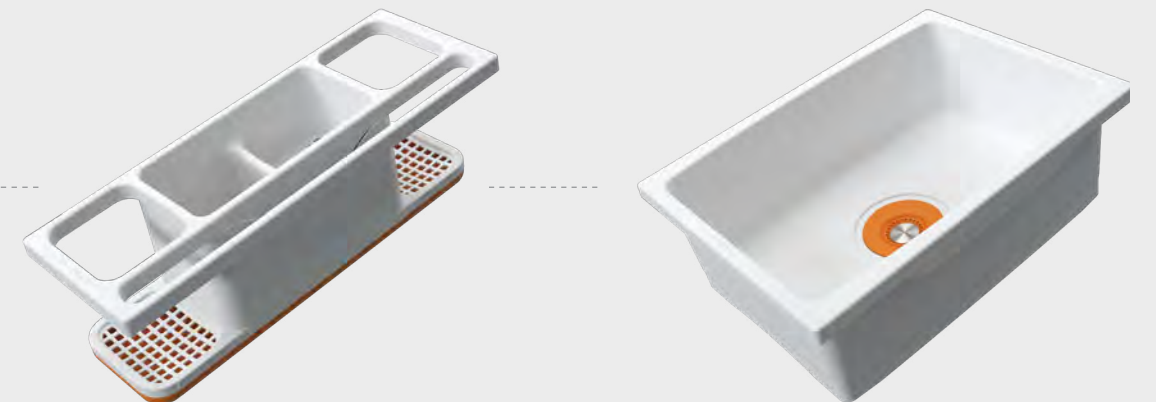



Ideal Corner WashStation™ 4X3C with Graphite Wood Composite / Graphite Resin+ Wash Kit, Polished Stainless Steel Tap, Soap Dispenser, and Deck Switch

Another great solution is around the corner

Like the Corner Workstation, the Corner WashStation™ makes great use of those awkward corner spaces in the kitchen. Get the most out of your kitchen with a Workstation + WashStation.

No cutting corners here





IDEAL CORNER WASHSTATIONS™

IWA-4X4-C

X-LARGE

Four Single Tier Wash Tools



-  Outside Corner
-  Inside Corner



IWA-4X3-C

LARGE

Four Single Tier Wash Tools

-  Outside Corner
-  Inside Corner



IWA-3X4-C

LARGE

Four Single Tier Wash Tools

-  Outside Corner
-  Inside Corner



Ideal Corner WashStation™ 4X4C

IWA-4X4-C-WA



MSRP \$8,095
UMRP \$7,286

American Black Walnut / Graphite Resin+

IWA-4X4-C-GT



MSRP \$7,995
UMRP \$7,196

Graphite Wood Composite / Graphite Resin+

IWA-4X4-C-BA



MSRP \$7,995
UMRP \$7,196

Natural Golden Bamboo / Exclusive Gray Resin+

IWA-4X4-C-GR



MSRP \$7,895
UMRP \$7,106

Exclusive Gray Resin+ / Resin+

IWA-4X4-C-WH



MSRP \$7,895
UMRP \$7,106

Designer White Resin+ / Resin+

Specifications

Single bowl
Users: 2 (Outside Corner), 1 (Inside Corner)
Wash Tools included: Four
Galley Tap(s) recommended:
Two (Outside Corner), One (Inside Corner)
Outside dimensions: 44" x 44" x 19 1/2" x 10 5/16"
Interior dimensions: 42" x 42" x 17" x 10"
Countertop cutout: 42 3/4" x 42 3/4" x 18"
Basin area: 42" x 42" x 16"
Min. cabinet size: 48" x 48" or 120cm x 120cm

Basin (KSO-4X4-C-SS)

16GA 316L stainless steel indoor/outdoor
SilentArmor™ sound reduction technology
Angel finish
Three tier design
Star™ groove pattern
Side drain
Drain cover included
Limited Lifetime Warranty
Made in the USA
ASME A112.19.3/CSA B45.4 certified
cUPC™ certified

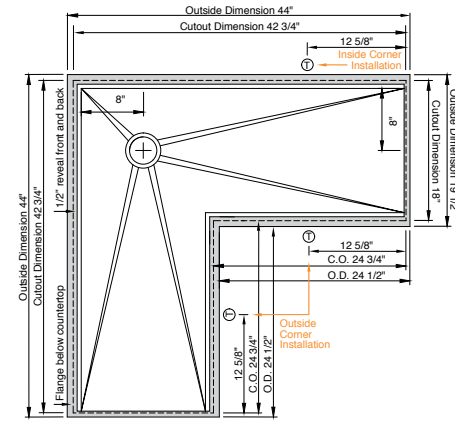

Center Galley Tap holes 2" from the back of the 18" countertop cutout

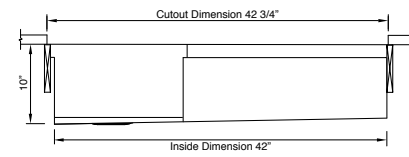

Wash Tools included (WKT-4T)



(1) Upper Tier Drying Rack 9 1/4" x 18" DR-09-U-xx
(1) Lower Tier Wash Caddy 6" x 17" WC-06-L-xx
(1) Lower Tier Wash Bowl 12" x 17" WB-12-L-xx
(1) Upper Tier Utensil Caddy 6" x 18" UC-06-U-xx

For Optional Culinary Tools see pages 85-90

Upper Deck.

Cover set UD-4X4-3P-WA/GT/BA/GR/WH Walnut, Graphite, Bamboo, Gray or White Resin

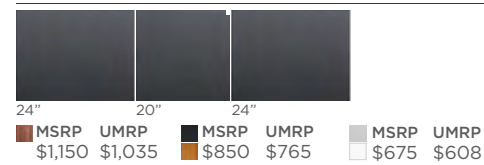

Sections Walnut, Graphite, Bamboo, Gray or White Resin



Ideal Corner WashStation™ 4X3C

IWA-4X3-C-WA



MSRP \$7,095
UMRP \$6,386

American Black Walnut / Graphite Resin+

IWA-4X3-C-GT



MSRP \$6,995
UMRP \$6,296

Graphite Wood Composite / Graphite Resin+

IWA-4X3-C-BA



MSRP \$6,995
UMRP \$6,296

Natural Golden Bamboo / Exclusive Gray Resin+

IWA-4X3-C-GR



MSRP \$6,895
UMRP \$6,206

Exclusive Gray Resin+ / Resin+

IWA-4X3-C-WH



MSRP \$6,895
UMRP \$6,206

Designer White Resin+ / Resin+

Specifications

Single bowl
Users: 2 (Outside Corner), 1 (Inside Corner)
Wash Tools included: Four
Galley Tap recommended: One
Outside dimensions: 44" x 32" x 19 1/2" x 10 5/16"
Interior dimensions: 42" x 30" x 17" x 10"
Countertop cutout: 42 3/4" x 30 3/4" x 18"
Basin area: 42" x 30" x 16"
Min. cabinet size: 48" x 36" or 120cm x 90cm

Basin (KSO-4X3-C-SS)

16GA 316L stainless steel indoor/outdoor
SilentArmor™ sound reduction technology
Angel finish
Three tier design
Star™ groove pattern
Side drain
Drain cover included
Limited Lifetime Warranty
Made in the USA
ASME A112.19.3/CSA B45.4 certified
cUPC™ certified

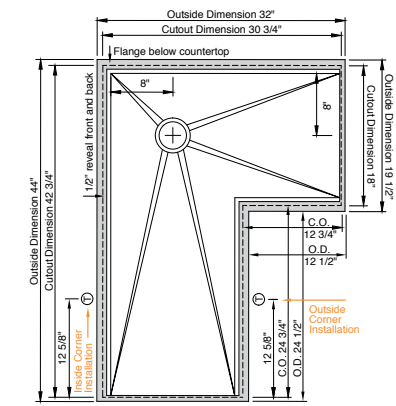

Center Galley Tap holes 2" from the back of the 18" countertop cutout

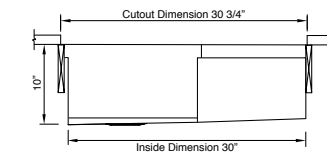

Wash Tools included (WKT-4T)



(1) Upper Tier Drying Rack 9 1/4" x 18" DR-09-U-xx
(1) Lower Tier Wash Caddy 6" x 17" WC-06-L-xx
(1) Lower Tier Wash Bowl 12" x 17" WB-12-L-xx
(1) Upper Tier Utensil Caddy 6" x 18" UC-06-U-xx

For Optional Culinary Tools see pages 85-90

Upper Deck.

Cover set UD-4X3-3P-WA/GT/BA/GR/WH Walnut, Graphite, Bamboo, Gray or White Resin

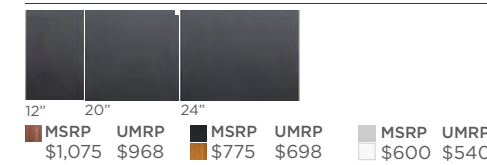

Sections Walnut, Graphite, Bamboo, Gray or White Resin





Ideal Work&WashStation™ 6D with Designer White Resin / Resin+ Kits, Matte Stainless Steel Taps, Hot & Cold Tap, Soap Dispenser, and Deck Switches

Divide and conquer

The Work&WashStation™ allows you to separate food preparation or prepare and wash in one Workstation. It is ideal when only one larger Workstation is possible. A thin stainless steel partition raises only to the lower tier allowing Cutting Boards and Drying Racks the freedom to slide all the way across both basins on the Lower Tier. This is also great for Kosher Cooking!

This is not your grandma's double bowl sink



IDEAL WORK&WASHSTATIONS™

IWW-7-D
X-LARGE

Eight Dual Tier
Culinary Tools &
Four Single Tier
Wash Tools



IWW-6-D
LARGE

Five Single Tier
Culinary Tools &
Four Single Tier
Wash Tools



IWW-5-D
MEDIUM

Five Single Tier
Culinary Tools &
Four Single Tier
Wash Tools



IWW-4-D
SMALL

Five Single Tier
Culinary Tools &
Four Single Tier
Wash Tools



Ideal Work&WashStation™ 7D

IWW-7-D-WA MSRP \$10,795 UMRP \$9,716



American Black Walnut / Graphite Resin+

IWW-7-D-GT MSRP \$10,195 UMRP \$9,176



Graphite Wood Composite / Graphite Resin+

IWW-7-D-BA MSRP \$10,195 UMRP \$9,176



Natural Golden Bamboo / Exclusive Gray Resin+

IWW-7-D-GR MSRP \$9,695 UMRP \$8,726



Exclusive Gray Resin+ / Resin+

IWW-7-D-WH MSRP \$9,695 UMRP \$8,726



Designer White Resin+ / Resin+

Culinary Tools included (CKT-17)

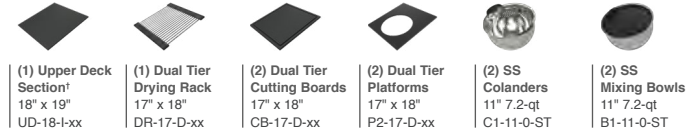

For Optional Culinary Tools see pages 85-90

† The Upper Deck requires a 1/4" clearance below the surface of the countertop. If the countertop thickness is 3/4" or less, Walnut or Bamboo Upper Deck sections will not have the clearance to function above the Upper Tier Culinary Tools.

Upper Deck.

Cover set UD-7-4P-WA/GT/BA/GR/WH Walnut, Graphite, Bamboo, Gray or White Resin

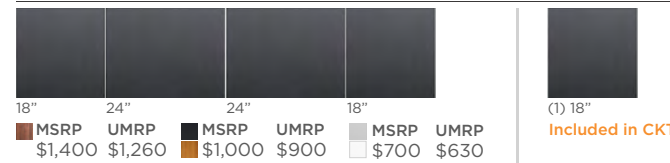

Sections Walnut, Graphite, Bamboo, Gray or White Resin



Specifications

Double bowl
Users: 1-3
Culinary/Wash Tools included: Twelve
Galley Taps recommended: Two
Outside dimensions: 81 1/2" x 19 1/2" x 10 5/16"
Interior dimensions: 80" x 17" x 10"
Countertop cutout: 80 1/2" x 18"
Basin area: 57 7/8", 21 7/8" x 16"
Minimum cabinet size: 84" or 210cm

Basin (KSO-7-D-SS)

16GA 316L stainless steel indoor/outdoor
SilentArmor™ sound reduction technology
Angel finish
Three tier design
Star™ groove pattern
Reversible center/side drain
Drain covers included
Limited Lifetime Warranty
Made in the USA
ASME A112.19.3/CSA B45.4 certified
cUPC™ certified

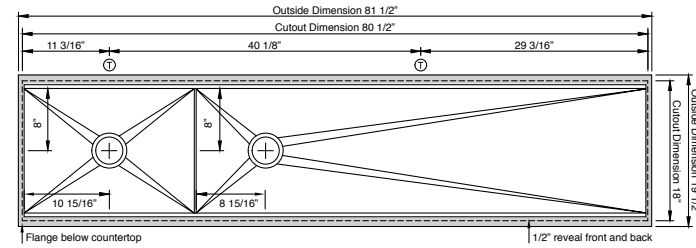

Center Galley Tap holes 2" from the back of the 18" countertop cutout

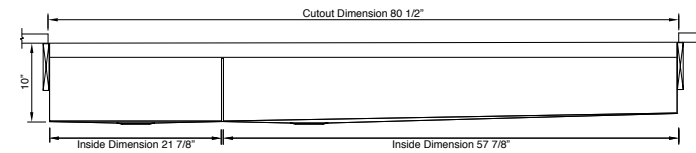

Customize Your Galley

Add 7-12" length	\$1,200	p. 80	9" depth	\$300	p. 80
Add 1-6" length	\$900	p. 80	Center drain	\$300	p. 80
Add 18" DryDock	\$1,800	p. 79	ThinTop™	\$500	p. 79
Add 12" DryDock	\$1,500	p. 79	WorkTop™	Custom	p. 79
Apron front	\$2,900	p. 79	*Color coded labels available		p. 87

Wash Tools included (WKT-4T)



For Galley Tap Suite see pages 93-112
For Freight see page 117

Recommended Basin Accessories & citrine.

Bottom Grate set BG-7-D-3-SS Stainless Steel



Strainer M-DRN-MSS Angel Finish 304 Stainless Steel



Auto Strainer Angel Finish 304 Stainless Steel with Polished or Matte knob



CIT-09-SS-C



CIT-09-WD-C



CIT-04-WD-B

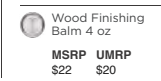

Ideal Work&WashStation™ 6D

IWW-6-D-WA MSRP \$9,295 UMRP \$8,366



American Black Walnut / Graphite Resin+

IWW-6-D-GT MSRP \$8,795 UMRP \$7,916



Graphite Wood Composite / Graphite Resin+

IWW-6-D-BA MSRP \$8,795 UMRP \$7,916



Natural Golden Bamboo / Exclusive Gray Resin+

IWW-6-D-GR MSRP \$8,395 UMRP \$7,556



Exclusive Gray Resin+ / Resin+

IWW-6-D-WH MSRP \$8,395 UMRP \$7,556



Designer White Resin+ / Resin+

Culinary Tools included (CKT-12)

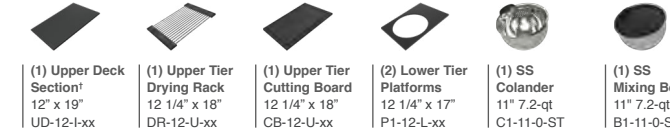

For Optional Culinary Tools see pages 85-90

† The Upper Deck requires a 1/4" clearance below the surface of the countertop. If the countertop thickness is 3/4" or less, Walnut or Bamboo Upper Deck sections will not have the clearance to function above the Upper Tier Culinary Tools.

Upper Deck.

Cover set UD-6-3P-WA/GT/BA/GR/WH Walnut, Graphite, Bamboo, Gray or White Resin

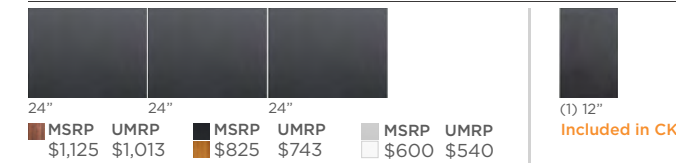

Sections Walnut, Graphite, Bamboo, Gray or White Resin



Specifications

Double bowl
Users: 1-2
Culinary/Wash Tools included: Nine
Galley Taps recommended: Two
Outside dimensions: 69 1/2" x 19 1/2" x 10 5/16"
Interior dimensions: 68" x 17" x 10"
Countertop cutout: 68 1/2" x 18"
Basin area: 45 7/8", 21 7/8" x 16"
Minimum cabinet size: 72" or 180cm

Basin (KSO-6-D-SS)

16GA 316L stainless steel indoor/outdoor
SilentArmor™ sound reduction technology
Angel finish
Three tier design
Star™ groove pattern
Reversible center/side drain
Drain covers included
Limited Lifetime Warranty
Made in the USA
ASME A112.19.3/CSA B45.4 certified
cUPC™ certified

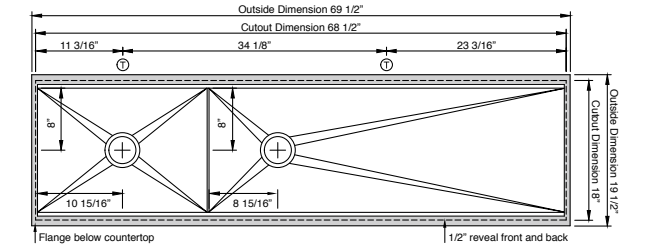

Center Galley Tap holes 2" from the back of the 18" countertop cutout

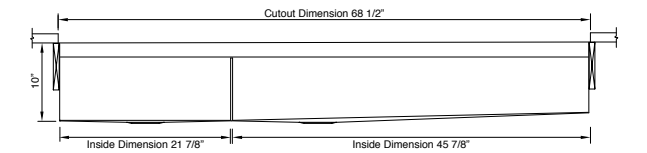

Customize Your Galley

Add 7-12" length	\$1,200	p. 80	9" depth	\$300	p. 80
Add 1-6" length	\$900	p. 80	Center drain	\$300	p. 80
Add 18" DryDock	\$1,800	p. 79	ThinTop™	\$500	p. 79
Add 12" DryDock	\$1,500	p. 79	WorkTop™	Custom	p. 79
Apron front	\$2,700	p. 79	*Color coded labels available		p. 87

Wash Tools included (WKT-4T)



For Galley Tap Suite see pages 93-112
For Freight see page 117

Recommended Basin Accessories & citrine.

Bottom Grate set BG-6-D-3-SS Stainless Steel

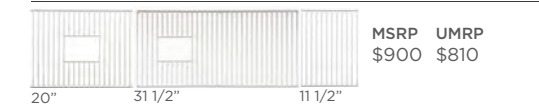

Strainer M-DRN-MSS Angel Finish 304 Stainless Steel



Auto Strainer Angel Finish 304 Stainless Steel with Polished or Matte knob

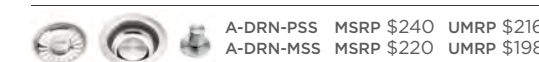

CIT-09-SS-C



CIT-09-WD-C



CIT-04-WD-B

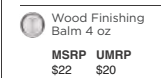

Ideal Work&WashStation™ 5D

IWW-5-D-WA MSRP \$8,695 UMRP \$7,826



American Black Walnut / Graphite Resin+

IWW-5-D-GT MSRP \$8,195 UMRP \$7,376



Graphite Wood Composite / Graphite Resin+

IWW-5-D-BA MSRP \$8,195 UMRP \$7,376



Natural Golden Bamboo / Exclusive Gray Resin+

IWW-5-D-GR MSRP \$7,795 UMRP \$7,016



Exclusive Gray Resin+ / Resin+

IWW-5-D-WH MSRP \$7,795 UMRP \$7,016



Designer White Resin+ / Resin+

Culinary Tools included (CKT-12)

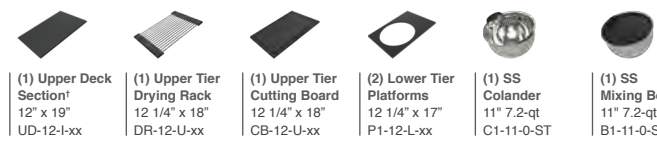

(1) Upper Deck Section† 12" x 19" UD-12-U-xx	(1) Upper Tier Drying Rack 12 1/4" x 18" DR-12-U-xx	(1) Upper Tier Cutting Board 12 1/4" x 18" CB-12-U-xx	(2) Lower Tier Platforms 12 1/4" x 17" P1-12-L-xx	(1) SS Colander 11" 7.2-qt C1-11-0-ST	(1) SS Mixing Bowl 11" 7.2-qt B1-11-0-ST
--	---	---	---	---	--

For Optional Culinary Tools see pages 85-90

† The Upper Deck requires a 1/4" clearance below the surface of the countertop. If the countertop thickness is 3/4" or less, Walnut or Bamboo Upper Deck sections will not have the clearance to function above the Upper Tier Culinary Tools.

Upper Deck.

Cover set UD-5-3P-WA/GT/BA/GR/WH Walnut, Graphite, Bamboo, Gray or White Resin

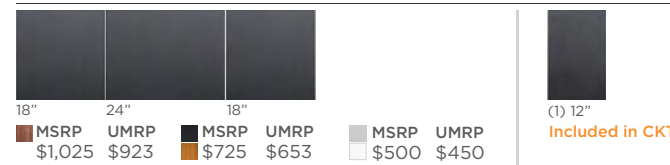

Sections Walnut, Graphite, Bamboo, Gray or White Resin

Upper Deck Sections		UD-12-1 MSRP UMRP		UD-12-1 MSRP UMRP	
UD-24-1	MSRP UMRP \$375 \$338	UD-12-1	MSRP UMRP \$325 \$293	UD-09-1	MSRP UMRP \$275 \$248
GT/BA	\$275 \$248	GT/BA	\$225 \$203	GT/BA	\$175 \$158
GR/WH	\$200 \$180	GR/WH	\$150 \$135	GR/WH	\$100 \$90

Specifications

Double bowl
Users: 1-2
Culinary/Wash Tools included: Nine
Galley Taps recommended: Two
Outside dimensions: 57 1/2" x 19 1/2" x 10 5/16"
Interior dimensions: 56" x 17" x 10"
Countertop cutout: 56 1/2" x 18"
Basin area: 33 7/8", 21 7/8" x 16"
Minimum cabinet size: 60" or 150cm

Basin (KSO-5-D-SS)

16GA 316L stainless steel indoor/outdoor
SilentArmor™ sound reduction technology
Angel finish
Three tier design
Star™ groove pattern
Reversible center/side drain
Drain covers included
Limited Lifetime Warranty
Made in the USA
ASME A112.19.3/CSA B45.4 certified
cUPC™ certified

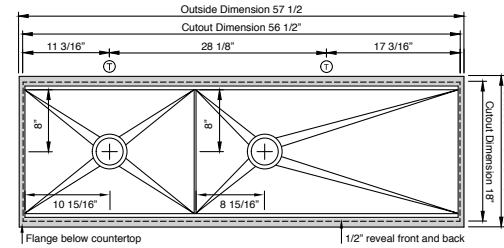

Center Galley Tap holes 2" from the back of the 18" countertop cutout

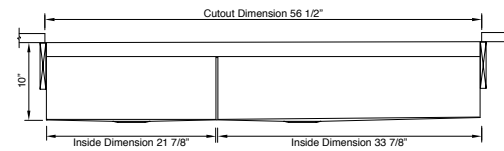

Customize Your Galley

Add 7-12" length	\$1,200	p. 80	9" depth	\$300	p. 80
Add 1-6" length	\$900	p. 80	Center drain	\$300	p. 80
Add 18" DryDock	\$1,800	p. 79	ThinTop™	\$500	p. 79
Add 12" DryDock	\$1,500	p. 79	WorkTop™	Custom	p. 79
Apron front	\$2,500	p. 79	*Color coded labels available		p. 87

Wash Tools included (WKT-4T)



(1) Upper Tier Drying Rack 9 1/4" x 18" DR-09-U-xx	(1) Lower Tier Wash Caddy 6" x 17" WC-06-L-xx	(1) Lower Tier Wash Bowl 12" x 17" WB-12-L-xx	(1) Upper Tier Utensil Caddy 6" x 18" UC-06-U-xx
--	---	---	--

For Galley Tap Suite see pages 93-112

For Freight see page 117

Recommended Basin Accessories & citrine.

Bottom Grate set BG-5-D-2-SS Stainless Steel



Strainer M-DRN-MSS Angel Finish 304 Stainless Steel



Disposal Strainer G-DRN-MSS Angel Finish 304 Stainless Steel



Auto Strainer Angel Finish 304 Stainless Steel with Polished or Matte knob

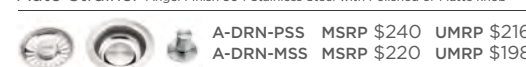

CIT-09-SS-C



CIT-09-WD-C



CIT-04-WD-B

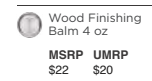

Ideal Work&WashStation™ 4D

IWW-4-D-WA MSRP \$7,695 UMRP \$6,926

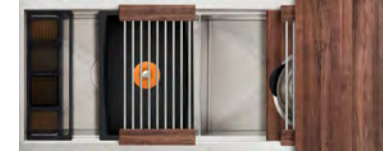

American Black Walnut / Graphite Resin+

IWW-4-D-GT MSRP \$7,195 UMRP \$6,476



Graphite Wood Composite / Graphite Resin+

IWW-4-D-BA MSRP \$7,195 UMRP \$6,476



Natural Golden Bamboo / Exclusive Gray Resin+

IWW-4-D-GR MSRP \$6,795 UMRP \$6,116



Exclusive Gray Resin+ / Resin+

IWW-4-D-WH MSRP \$6,795 UMRP \$6,116



Designer White Resin+ / Resin+

Culinary Tools included (CKT-12)

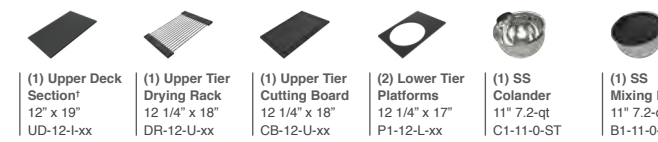

(1) Upper Deck Section† 12" x 19" UD-12-U-xx	(1) Upper Tier Drying Rack 12 1/4" x 18" DR-12-U-xx	(1) Upper Tier Cutting Board 12 1/4" x 18" CB-12-U-xx	(2) Lower Tier Platforms 12 1/4" x 17" P1-12-L-xx	(1) SS Colander 11" 7.2-qt C1-11-0-ST	(1) SS Mixing Bowl 11" 7.2-qt B1-11-0-ST
--	---	---	---	---	--

For Optional Culinary Tools see pages 85-90

† The Upper Deck requires a 1/4" clearance below the surface of the countertop. If the countertop thickness is 3/4" or less, Walnut or Bamboo Upper Deck sections will not have the clearance to function above the Upper Tier Culinary Tools.

Upper Deck.

Cover set UD-4-2P-WA/GT/BA/GR/WH Walnut, Graphite, Bamboo, Gray or White Resin

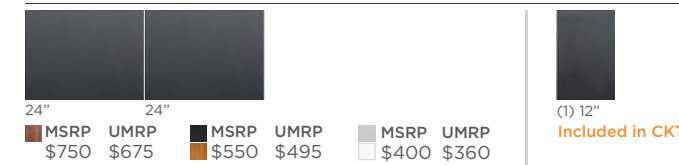

Sections Walnut, Graphite, Bamboo, Gray or White Resin

Upper Deck Sections		UD-24-1 MSRP UMRP		UD-12-1 MSRP UMRP	
UD-24-1	MSRP UMRP \$375 \$338	UD-24-1	MSRP UMRP \$300 \$270	UD-12-1	MSRP UMRP \$275 \$248
GT/BA	\$275 \$248	GT/BA	\$200 \$180	GT/BA	\$175 \$158
GR/WH	\$200 \$180	GR/WH	\$125 \$113	GR/WH	\$125 \$113

Specifications

Double bowl
Users: 1
Culinary/Wash Tools included: Nine
Galley Tap recommended: One
Outside dimensions: 45 1/2" x 19 1/2" x 10 5/16"
Interior dimensions: 44" x 17" x 10"
Countertop cutout: 44 1/2" x 18"
Basin area: 21 7/8", 21 7/8" x 16"
Minimum cabinet size: 48" or 120cm

Basin (KSO-4-D-SS)

16GA 316L stainless steel indoor/outdoor
SilentArmor™ sound reduction technology
Angel finish
Three tier design
Star™ groove pattern
Center drains
Drain covers included
Limited Lifetime Warranty
Made in the USA
ASME A112.19.3/CSA B45.4 certified
cUPC™ certified

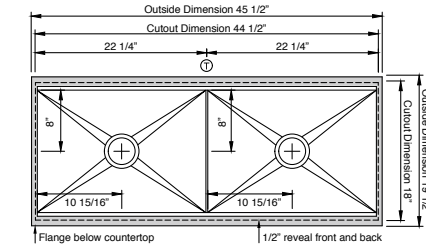

Center Galley Tap holes 2" from the back of the 18" countertop cutout

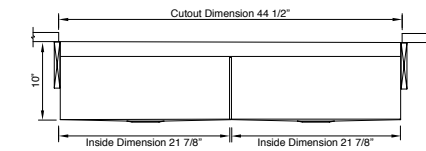

Customize Your Galley

Add 7-12" length	\$1,200	p. 80	9" depth	\$300	p. 80
Add 1-6" length	\$900	p. 80	Center drain	\$300	p. 80
Add 18" DryDock	\$1,800	p. 79	ThinTop™	\$500	p. 79
Add 12" DryDock	\$1,500	p. 79	WorkTop™	Custom	p. 79
Apron front	\$2,300	p. 79	*Color coded labels available		p. 87

Wash Tools included (WKT-4T)



(1) Upper Tier Drying Rack 9 1/4" x 18" DR-09-U-xx	(1) Lower Tier Wash Caddy 6" x 17" WC-06-L-xx	(1) Lower Tier Wash Bowl 12" x 17" WB-12-L-xx	(1) Upper Tier Utensil Caddy 6" x 18" UC-06-U-xx
--	---	---	--

For Galley Tap Suite see pages 93-112

For Freight see page 117

Recommended Basin Accessories & citrine.

Bottom Grate set BG-4-D-2-SS Stainless Steel



Strainer M-DRN-MSS Angel Finish 304 Stainless Steel



Disposal Strainer G-DRN-MSS Angel Finish 304 Stainless Steel



Auto Strainer Angel Finish 304 Stainless Steel with Polished or Matte knob

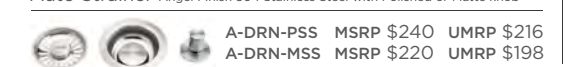

CIT-09-SS-C

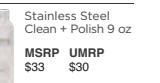

CIT-09-WD-C



CIT-04-WD-B





Ideal BarStation. 2 with Graphite Wood Composite Bar Kit, PVD Satin Black Stainless Steel BarTap, and Soap Dispenser

IDEAL BARSTATIONS.

IBS-2-C Three Single Tier Bar Tools
LARGE 



IBS-18-C Three Single Tier Bar Tools
MEDIUM 



Mixology at its best

Cut, muddle, shake, and mix a fresh cocktail all at the Galley BarStation®! Including its very own convenient Bar Kit, perfect for slicing limes, serving condiments and washing and drying your glasses.

Bar none, the best ever

Ideal BarStation. 2

IBS-2-C-WA



American Black Walnut

MSRP \$2,995
UMRP \$2,696

IBS-2-C-GT



Graphite Wood Composite

MSRP \$2,795
UMRP \$2,516

IBS-2-C-BA



Natural Golden Bamboo

MSRP \$2,795
UMRP \$2,516

IBS-2-C-GR



Exclusive Gray Resin

MSRP \$2,595
UMRP \$2,336

IBS-2-C-WH



Designer White Resin

MSRP \$2,595
UMRP \$2,336

Bar Tools included (BKT-3T)

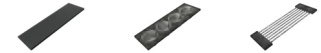

- (1) Upper Deck Section†
6" x 19"
UD-06-l-xx
- (1) Upper Tier Garnish Board
6" x 18"
SB-06-U-xx
- (1) Lower Tier Mini Drying Rack
6" x 17"
DR-06-L-xx

For Optional Culinary Tools see pages 85-90

† The Upper Deck requires a 1/4" clearance below the surface of the countertop. If the countertop thickness is 3/4" or less, Walnut or Bamboo Upper Deck sections will not have the clearance to function above the Upper Tier Culinary Tools.

Upper Deck.

Cover set UD-2-2P-WA/GT/BA/GR/WH Walnut, Graphite, Bamboo, Gray or White Resin

12"	12"	(1) 6"
MSRP UMRP \$600 \$540	MSRP UMRP \$400 \$360	MSRP UMRP \$250 \$225

Included in BKT

Sections Walnut, Graphite, Bamboo, Gray or White Resin

		Upper Deck Sections
UD-12-1	UD-06-1	UD-12-1 MSRP UMRP WA \$300 \$270 GT/BA \$200 \$180 GR/WH \$125 \$113
		UD-06-1 MSRP UMRP WA \$275 \$248 GT/BA \$175 \$158 GR/WH \$100 \$90

Specifications

Single bowl
Users: 1
Bar Tools included: Three
Galley BarTap, recommended: One
Outside dimensions: 22" x 19 1/2" x 10 5/16"
Interior dimensions: 20 1/2" x 17" x 10"
Countertop cutout: 21" x 18"
Basin area: 20 1/2" x 16"
Minimum cabinet size: 24" or 60cm

Basin (KSO-2-C-SS)

16GA 316L stainless steel indoor/outdoor
SilentArmor™ sound reduction technology
Angel finish
Three tier design
Star™ groove pattern
Center drain
Drain cover included
Limited Lifetime Warranty
Made in the USA
ASME A112.19.3/CSA B45.4 certified
cUPC™ certified

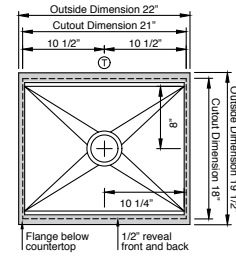

Center Galley Tap holes 2" from the back of the 18" countertop cutout

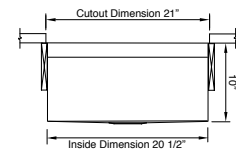

Customize Your Galley

Add 7-12" length	\$1,200	p. 80	9" depth	\$300	p. 80
Add 1-6" length	\$900	p. 80	ThinTop™	\$500	p. 79
Add 18" DryDock	\$1,800	p. 79	WorkTop™	Custom	p. 79
Add 12" DryDock	\$1,500	p. 79	*Color coded labels available		p. 87
Apron front	\$1,900	p. 79			

Ideal BarStation. 18

IBS-18-C-WA



American Black Walnut

MSRP \$2,695
UMRP \$2,426

IBS-18-C-GT



Graphite Wood Composite

MSRP \$2,495
UMRP \$2,246

IBS-18-C-BA



Natural Golden Bamboo

MSRP \$2,495
UMRP \$2,246

IBS-18-C-GR



Exclusive Gray Resin

MSRP \$2,295
UMRP \$2,066

IBS-18-C-WH



Designer White Resin

MSRP \$2,295
UMRP \$2,066

Bar Tools included (BKT-3T)

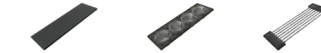

- (1) Upper Deck Section†
6" x 19"
UD-06-l-xx
- (1) Upper Tier Garnish Board
6" x 18"
SB-06-U-xx
- (1) Lower Tier Mini Drying Rack
6" x 17"
DR-06-L-xx

For Optional Culinary Tools see pages 85-90

† The Upper Deck requires a 1/4" clearance below the surface of the countertop. If the countertop thickness is 3/4" or less, Walnut or Bamboo Upper Deck sections will not have the clearance to function above the Upper Tier Culinary Tools.

Upper Deck.

Cover set UD-18-2P-WA/GT/BA/GR/WH Walnut, Graphite, Bamboo, Gray or White Resin

9"	9"	(1) 6"
MSRP UMRP \$550 \$495	MSRP UMRP \$350 \$315	MSRP UMRP \$200 \$180

Included in BKT

Sections Walnut, Graphite, Bamboo, Gray or White Resin

			Upper Deck Sections
UD-12-1	UD-09-1	UD-06-1	UD-12-1 MSRP UMRP WA \$300 \$270 GT/BA \$200 \$180 GR/WH \$125 \$113
			UD-09-1 MSRP UMRP WA \$275 \$248 GT/BA \$175 \$158 GR/WH \$100 \$90
			UD-06-1 MSRP UMRP WA \$275 \$248 GT/BA \$175 \$158 GR/WH \$100 \$90

Specifications

Single bowl
Users: 1
Bar Tools included: Three
Galley BarTap, recommended: One
Outside dimensions: 15 1/2" x 19 1/2" x 10 5/16"
Interior dimensions: 14" x 17" x 10"
Countertop cutout: 14 1/2" x 18"
Basin area: 14" x 16"
Minimum cabinet size: 18" or 40cm

Basin (KSO-18-C-SS)

16GA 316L stainless steel indoor/outdoor
SilentArmor™ sound reduction technology
Angel finish
Three tier design
Star™ groove pattern
Center drain
Drain cover included
Limited Lifetime Warranty
Made in the USA
ASME A112.19.3/CSA B45.4 certified
cUPC™ certified

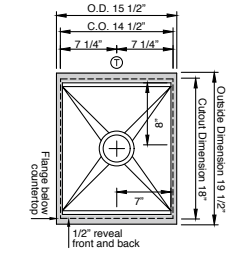

Center Galley Tap holes 2" from the back of the 18" countertop cutout

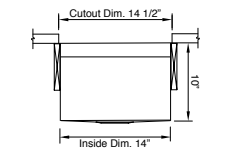

Customize Your Galley

Add 7-12" length	\$1,200	p. 80	9" depth	\$300	p. 80
Add 1-6" length	\$900	p. 80	ThinTop™	\$500	p. 79
Add 18" DryDock	\$1,800	p. 79	WorkTop™	Custom	p. 79
Add 12" DryDock	\$1,500	p. 79	*Color coded labels available		p. 87
Apron front	\$1,800	p. 79			

Ideal HydroStation™



Ideal HydroStation™ with American Black Walnut HydroPlate, PVD Satin Black Stainless Steel Hot & Cold Tap

IHS-1-V-WA



MSRP \$1,275
UMRP \$1,148

American Black Walnut

IHS-1-V-GT



MSRP \$1,250
UMRP \$1,125

Graphite Wood Composite

IHS-1-V-BA



MSRP \$1,250
UMRP \$1,125

Natural Golden Bamboo

IHS-1-V-GR



MSRP \$1,225
UMRP \$1,103

Exclusive Gray Resin

IHS-1-V-WH



MSRP \$1,225
UMRP \$1,103

Designer White Resin

Specifications

Single bowl
Users: 1
Hydro Tool included: One
Galley Hot & Cold Tap recommended: One
Outside dimensions: 9" x 13 1/2" x 1 15/16"
Interior dimensions: 6 1/2" x 12" x 1 5/8"
Countertop cutout: 7 1/2" x 12"
Basin drain opening: 2"
Basin area: 6 1/2" x 12"

Basin (HSO-1-V-SS)

16GA 316L stainless steel indoor/outdoor
SilentArmor™ sound reduction technology
Angel finish
One tier design
Star™ groove pattern
Drain included
Drain cover included
Limited Lifetime Warranty
Made in the USA
ASME A112.19.3/CSA B45.4 certified
cUPC™ certified

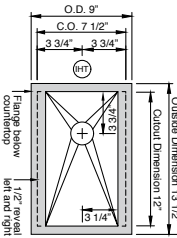

Center Galley Tap hole 2" from the back of the 12" countertop cutout

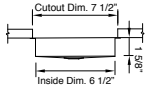

Cutout Dim. 7 1/2"

Inside Dim. 6 1/2"

1 5/8"

Stay hydrated my friends

Enjoy the taste and convenience of drinking clean, filtered water while improving your health and wellbeing. Designed specifically for the Galley Hot & Cold Tap, the HydroStation™ includes a HydroPlate for glasses and cups and can be located virtually anywhere in your kitchen and throughout your home.

For your health

Hydro Tool included (HP-7X7)



(1) HydroPlate
7" x 7"
HP-7X7-xx

Upper Deck.

Cover set UD-1-1P-WA/GT/BA/GR/WH Walnut, Graphite, Bamboo, Gray or White Resin



MSRP UMRP MSRP UMRP MSRP UMRP
\$250 \$225 \$150 \$135 \$75 \$68

Customize Your Galley

ThinTop™	\$500	p. 79
WorkTop™	Custom	p. 79

For Galley Tap Suite see pages 93-112
For Freight see page 117

Basin Accessories & citrine.

Hydro Drain H-DRN-MSS Angel Finish 304 Stainless Steel



Included with HydroStation

CIT-09-SS-C

Stainless Steel Clean + Polish 9 oz
MSRP UMRP
\$33 \$30

CIT-09-WD-C

Wood Condition + Protect 9 oz
MSRP UMRP
\$25 \$23

CIT-04-WD-B

Wood Finishing Balm 4 oz
MSRP UMRP
\$22 \$20





Ideal Workstation 4S + 12" DryDock with Graphite Wood Composite Culinary Kit and DryDock Tool, PVD Gun Metal Gray™ Stainless Steel Tap, Soap Dispenser, and Deck Switch

The Galley Workstation takes on a bold form

Expand the functionality of your Galley without sacrificing under-counter storage or appliances by adding a 18 or 12 inch Built-in DryDock® to either or both sides of any single or double bowl Workstation. Highly engineered for function, it expands the useful space in the basin by allowing you to dock your Culinary Tools to the side when you need more space.

Make the most of your Galley



Add a DryDock®
Extend Your Galley

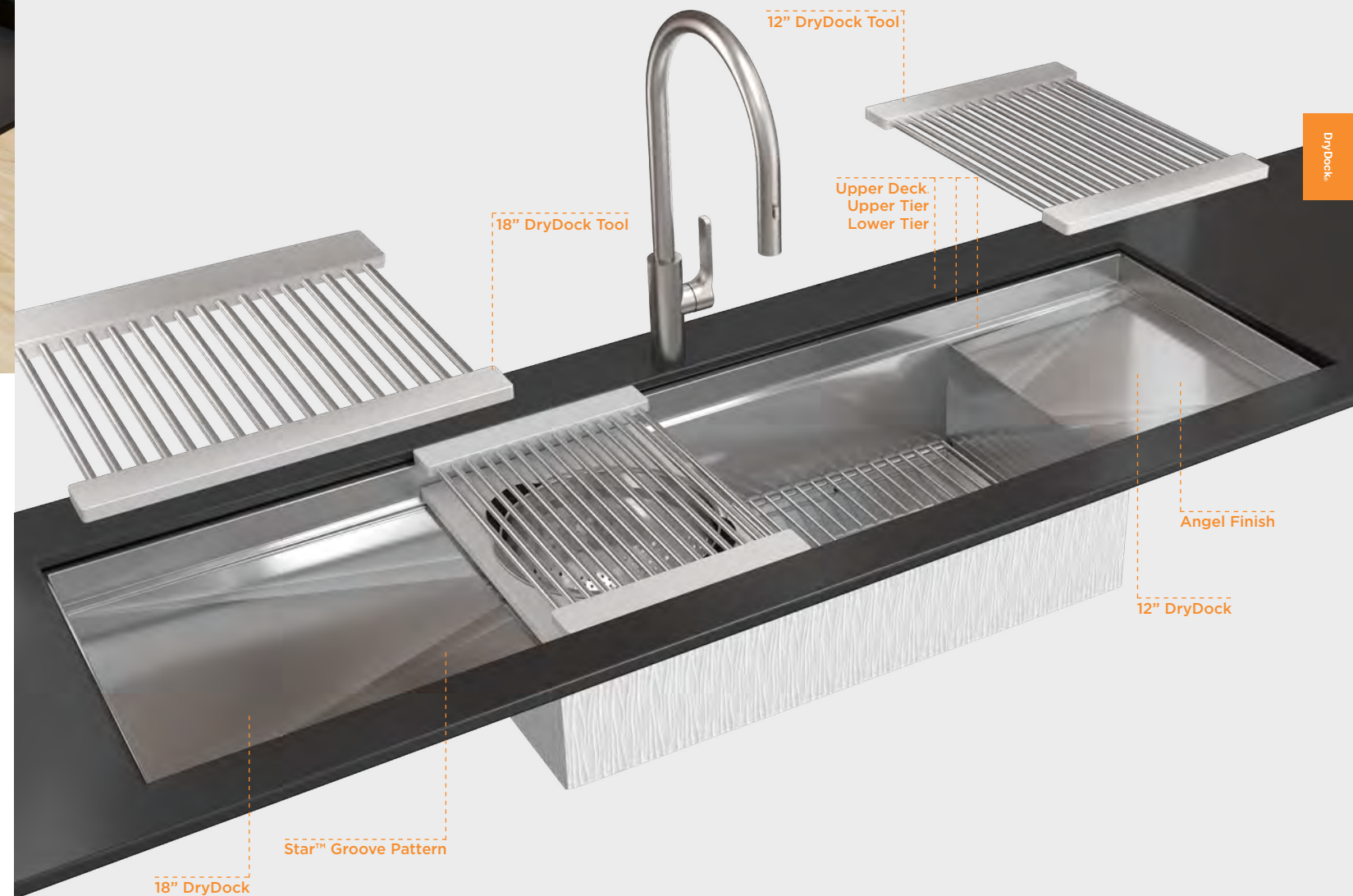

Minimum 2" clearance below countertop is required



DryDock Tool Materials				
Prestige	Premium		Standard	
American Black Walnut (WA)	Graphite Wood Composite (GT)	Natural Golden Bamboo (BA)	Exclusive Gray Resin (GR)	Designer White Resin (WH)

DryDock® 18

Add to any Workstation. Over 138 possibilities.

DD-18-S



Specifications

DryDock Tool included: One
 Outside dimensions: 18" x 19 1/2" x 2 1/16"
 Countertop cutout: Add 18" to IWS width
 Minimum cabinet size: Add 18" to IWS width
 Minimum clearance required below countertop: 2"
 Location: Drain side (S) and/or non-drain side (N)
 and/or center drain (C)

Basin (DS-18)

16GA 316L stainless steel indoor/outdoor
 SilentArmor™ sound reduction technology
 Angel finish
 Three tier design
 Star™ groove pattern
 Limited Lifetime Warranty
 Made in the USA
 ASME A112.19.3/CSA B45.4 certified

DryDock Tool included (DR-18)



(1) Dual Tier Drying Rack
 18" x 17"
 DR-18-D-WA
 MSRP \$2,175
 UMRP \$1,958



(1) Dual Tier Drying Rack
 18" x 17"
 DR-18-D-GT
 MSRP \$2,125
 UMRP \$1,913



(1) Dual Tier Drying Rack
 18" x 17"
 DR-18-D-BA
 MSRP \$2,125
 UMRP \$1,913



(1) Dual Tier Drying Rack
 18" x 17"
 DR-18-D-GR
 MSRP \$2,050
 UMRP \$1,845



(1) Dual Tier Drying Rack
 18" x 17"
 DR-18-D-WH
 MSRP \$2,050
 UMRP \$1,845

EXAMPLE 1

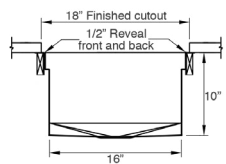

Suggested maximum inside corner radius of countertop cutout 3/8"

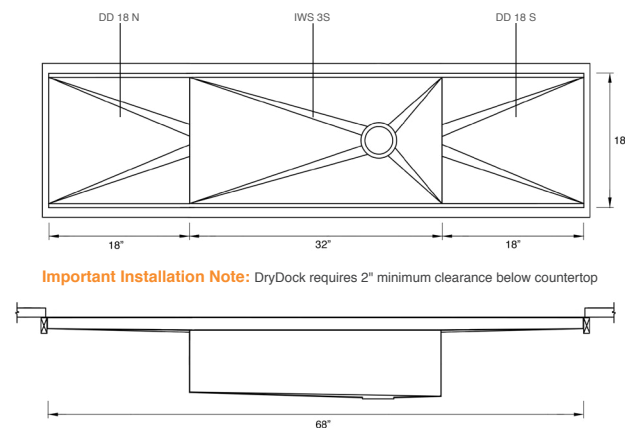

Important Installation Note: DryDock requires 2" minimum clearance below countertop

IWS-3-S-DD-18-N-DD-18-S-xx

EXAMPLE 2

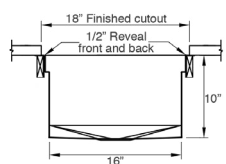

Suggested maximum inside corner radius of countertop cutout 3/8"

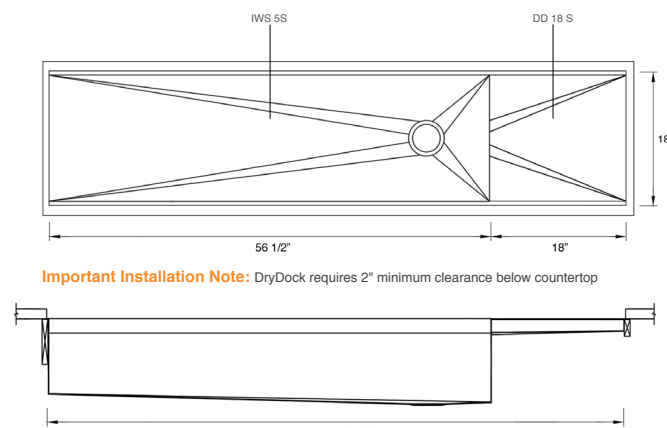

Important Installation Note: DryDock requires 2" minimum clearance below countertop

IWS-5-S-DD-18-S-xx

DryDock® 12

Add to any Workstation. Over 138 possibilities.

DD-12-S



Specifications

DryDock Tool included: One
 Outside dimensions: 12" x 19 1/2" x 2 1/16"
 Countertop cutout: Add 12" to IWS width
 Minimum cabinet size: Add 12" to IWS width
 Minimum clearance required below countertop: 2"
 Location: Drain side (S) and/or non-drain side (N)
 and/or center drain (C)

Basin (DS-12)

16GA 316L stainless steel indoor/outdoor
 SilentArmor™ sound reduction technology
 Angel finish
 Three tier design
 Star™ groove pattern
 Limited Lifetime Warranty
 Made in the USA
 ASME A112.19.3/CSA B45.4 certified

DryDock Tool included (DR-12)



(1) Lower Tier Drying Rack
 12 1/4" x 17"
 DR-12-L-WA
 MSRP \$1,825
 UMRP \$1,643



(1) Lower Tier Drying Rack
 12 1/4" x 17"
 DR-12-L-GT
 MSRP \$1,775
 UMRP \$1,598



(1) Lower Tier Drying Rack
 12 1/4" x 17"
 DR-12-L-BA
 MSRP \$1,775
 UMRP \$1,598



(1) Lower Tier Drying Rack
 12 1/4" x 17"
 DR-12-L-GR
 MSRP \$1,725
 UMRP \$1,553



(1) Lower Tier Drying Rack
 12 1/4" x 17"
 DR-12-L-WH
 MSRP \$1,725
 UMRP \$1,553

EXAMPLE 3

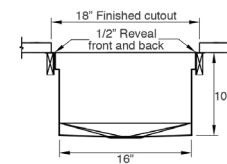

Suggested maximum inside corner radius of countertop cutout 3/8"

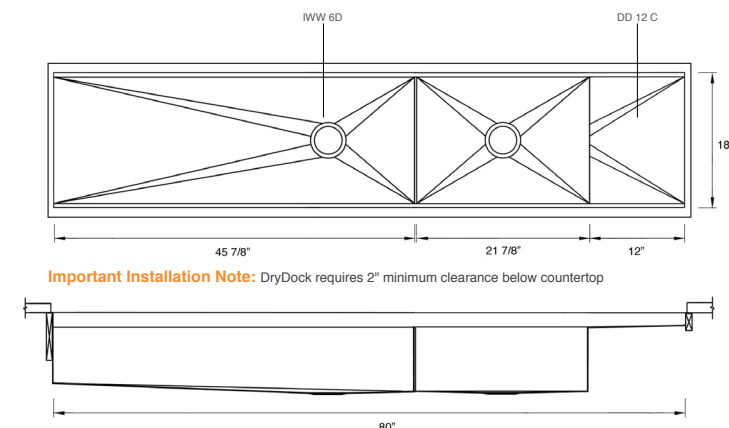

Important Installation Note: DryDock requires 2" minimum clearance below countertop

IWW-6-D-DD-12-C-xx

EXAMPLE 4

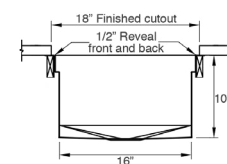

Suggested maximum inside corner radius of countertop cutout 3/8"

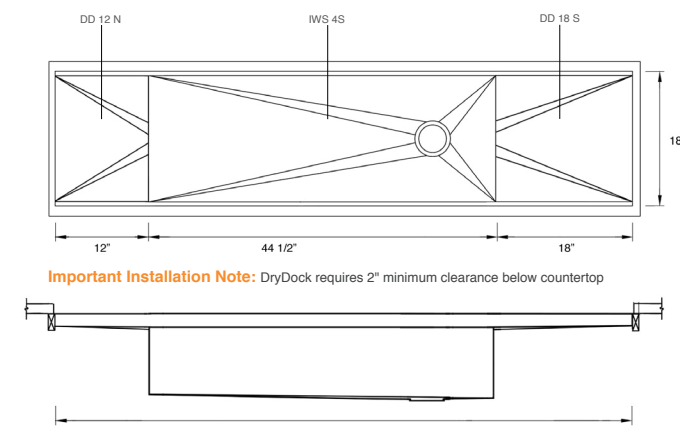

Important Installation Note: DryDock requires 2" minimum clearance below countertop

IWS-4-S-DD-12-N-DD-18-S-xx

Ideal Workstation. 4S + DryDock. 18

IWS-4-S-DD-18-S-WA



MSRP \$7,470
UMRP \$6,723

American Black Walnut

IWS-4-S-DD-18-S-GT



MSRP \$7,020
UMRP \$6,318

Graphite Wood Composite

IWS-4-S-DD-18-S-BA



MSRP \$7,020
UMRP \$6,318

Natural Golden Bamboo

IWS-4-S-DD-18-S-GR



MSRP \$6,645
UMRP \$5,981

Exclusive Gray Resin*

IWS-4-S-DD-18-S-WH



MSRP \$6,645
UMRP \$5,981

Designer White Resin*

Culinary Tools included (CKT-12)

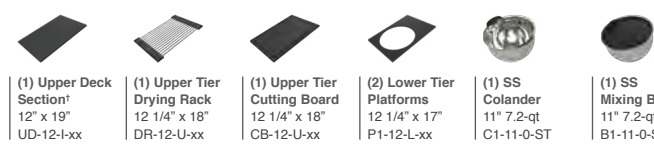

For Optional Culinary Tools see pages 85-90

† The Upper Deck requires a 1/4" clearance below the surface of the countertop. If the countertop thickness is 3/4" or less, Walnut or Bamboo Upper Deck sections will not have the clearance to function above the Upper Tier Culinary Tools.

Upper Deck.

Cover set UD-4-18-3P-WA/GT/BA/GR/WH Walnut, Graphite, Bamboo, Gray or White Resin

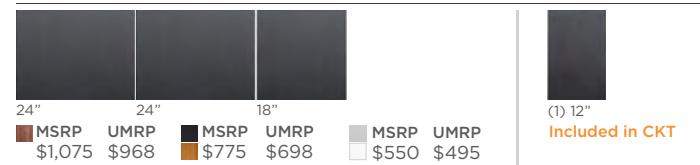

Sections Walnut, Graphite, Bamboo, Gray or White Resin



Specifications

Single bowl
Users: 1
Culinary Tools included: Five
DryDock Tool included: One
Galley Tap recommended: One
Outside dimensions: 63 1/2" x 19 1/2" x 2 1/16"
Interior dimensions: 62" x 17" x 2"
Countertop cutout: 62 1/2" x 18"
Minimum cabinet size: 66" or 165cm
Minimum clearance required for DryDock below countertop: 2"
DryDock location: Drain side (S)

Basin (KSO-4-S-DS-18-S-SS)

16GA 316L stainless steel indoor/outdoor
SilentArmor™ sound reduction technology
Angel finish
Three tier design
Star™ groove pattern
Reversible side drain
Drain cover included
Limited Lifetime Warranty
Made in the USA
ASME A112.19.3/CSA B45.4 certified
cUPC™ certified

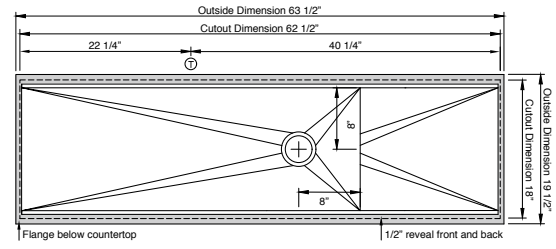

Center Galley Tap holes 2" from the back of the 18" countertop cutout

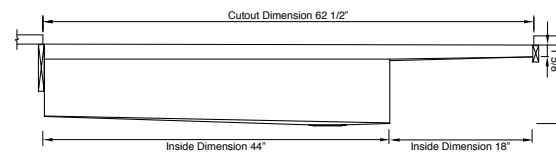

Important Installation Note: DryDock requires 2" minimum clearance below countertop

Customize Your Galley

Add 7-12" length	\$1,200	p. 80	9" depth	\$300	p. 80
Add 1-6" length	\$900	p. 80	Center drain	\$300	p. 80
Add 18" DryDock	\$1,800	p. 79	ThinTop™	\$500	p. 79
Add 12" DryDock	\$1,500	p. 79	WorkTop™	Custom	p. 79
Apron front	\$2,300	p. 79	*Color coded labels available		p. 87

DryDock Tool included (DR-12)



For Galley Tap Suite see pages 93-112
For Freight see page 117

Recommended Basin Accessories & citrine.

Bottom Grate set BG-4-S-2-SS Stainless Steel



CIT-09-SS-C



CIT-09-WD-C



CIT-04-WD-B

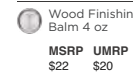

Strainer M-DRN-MSS Angel Finish 304 Stainless Steel
MSRP \$110 UMRP \$99

Disposal Strainer G-DRN-MSS Angel Finish 304 Stainless Steel
MSRP \$110 UMRP \$99

Auto Strainer Angel Finish 304 Stainless Steel with Polished or Matte knob
A-DRN-PSS MSRP \$240 UMRP \$216
A-DRN-MSS MSRP \$220 UMRP \$198

A-DRN-MSS shown

Ideal Workstation. 4S + DryDock. 12

IWS-4-S-DD-12-S-WA



MSRP \$7,120
UMRP \$6,408

American Black Walnut

IWS-4-S-DD-12-S-GT



MSRP \$6,670
UMRP \$6,003

Graphite Wood Composite

IWS-4-S-DD-12-S-BA



MSRP \$6,670
UMRP \$6,003

Natural Golden Bamboo

IWS-4-S-DD-12-S-GR



MSRP \$6,320
UMRP \$5,688

Exclusive Gray Resin*

IWS-4-S-DD-12-S-WH



MSRP \$6,320
UMRP \$5,688

Designer White Resin*

Culinary Tools included (CKT-12)

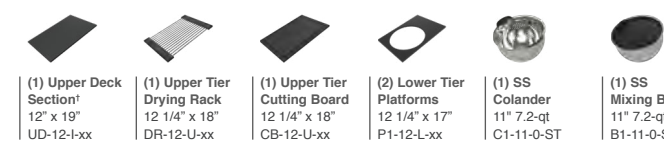

For Optional Culinary Tools see pages 85-90

† The Upper Deck requires a 1/4" clearance below the surface of the countertop. If the countertop thickness is 3/4" or less, Walnut or Bamboo Upper Deck sections will not have the clearance to function above the Upper Tier Culinary Tools.

Upper Deck.

Cover set UD-4-12-3P-WA/GT/BA/GR/WH Walnut, Graphite, Bamboo, Gray or White Resin

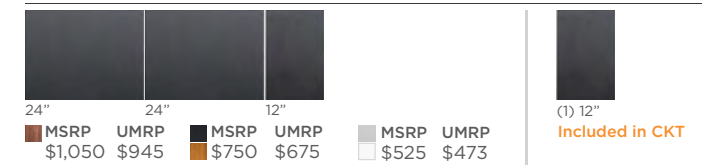

Sections Walnut, Graphite, Bamboo, Gray or White Resin

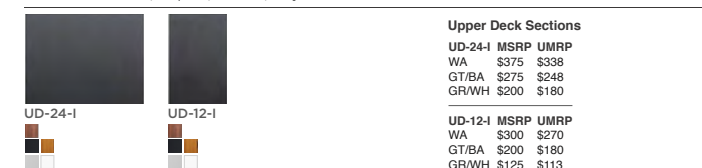

Specifications

Single bowl
Users: 1
Culinary Tools included: Five
DryDock Tool included: One
Galley Tap recommended: One
Outside dimensions: 57 1/2" x 19 1/2" x 2 1/16"
Interior dimensions: 56" x 17" x 2"
Countertop cutout: 56 1/2" x 18"
Minimum cabinet size: 60" or 150cm
Minimum clearance required for DryDock below countertop: 2"
DryDock location: Drain side (S)

Basin (KSO-4-S-DS-12-S-SS)

16GA 316L stainless steel indoor/outdoor
SilentArmor™ sound reduction technology
Angel finish
Three tier design
Star™ groove pattern
Reversible side drain
Drain cover included
Limited Lifetime Warranty
Made in the USA
ASME A112.19.3/CSA B45.4 certified
cUPC™ certified

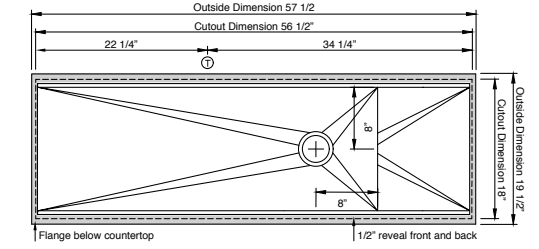

Center Galley Tap holes 2" from the back of the 18" countertop cutout

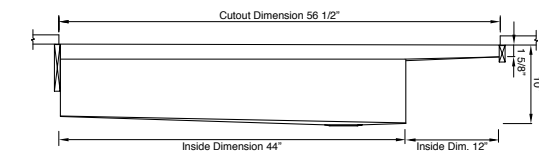

Important Installation Note: DryDock requires 2" minimum clearance below countertop

Customize Your Galley

Add 7-12" length	\$1,200	p. 80	9" depth	\$300	p. 80
Add 1-6" length	\$900	p. 80	Center drain	\$300	p. 80
Add 18" DryDock	\$1,800	p. 79	ThinTop™	\$500	p. 79
Add 12" DryDock	\$1,500	p. 79	WorkTop™	Custom	p. 79
Apron front	\$2,300	p. 79	*Color coded labels available		p. 87

DryDock Tool included (DR-12)



For Galley Tap Suite see pages 93-112
For Freight see page 117

Recommended Basin Accessories & citrine.

Bottom Grate set BG-4-S-2-SS Stainless Steel

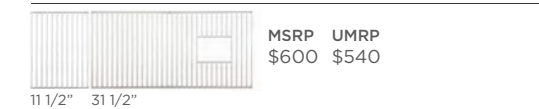

CIT-09-SS-C

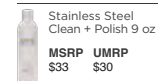

CIT-09-WD-C



CIT-04-WD-B

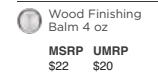

Strainer M-DRN-MSS Angel Finish 304 Stainless Steel
MSRP \$110 UMRP \$99

Disposal Strainer G-DRN-MSS Angel Finish 304 Stainless Steel
MSRP \$110 UMRP \$99

Auto Strainer Angel Finish 304 Stainless Steel with Polished or Matte knob
A-DRN-PSS MSRP \$240 UMRP \$216
A-DRN-MSS MSRP \$220 UMRP \$198

A-DRN-MSS shown

Ideal Workstation. 3S + DryDock. 18

IWS-3-S-DD-18-S-WA



MSRP \$6,470
UMRP \$5,823

American Black Walnut

IWS-3-S-DD-18-S-GT



MSRP \$6,020
UMRP \$5,418

Graphite Wood Composite

IWS-3-S-DD-18-S-BA



MSRP \$6,020
UMRP \$5,418

Natural Golden Bamboo

IWS-3-S-DD-18-S-GR



MSRP \$5,645
UMRP \$5,081

Exclusive Gray Resin*

IWS-3-S-DD-18-S-WH



MSRP \$5,645
UMRP \$5,081

Designer White Resin*

Culinary Tools included (CKT-12)

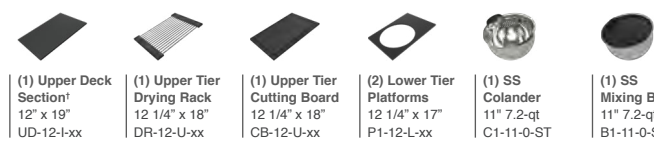

- | | | | | | |
|--|---|---|---|---|--|
| (1) Upper Deck Section†
12" x 19"
UD-12-l-xx | (1) Upper Tier Drying Rack
12 1/4" x 18"
DR-12-U-xx | (1) Upper Tier Cutting Board
12 1/4" x 18"
CB-12-U-xx | (2) Lower Tier Platforms
12 1/4" x 17"
P1-12-L-xx | (1) SS Colander
11" 7.2-qt
C1-11-0-ST | (1) SS Mixing Bowl
11" 7.2-qt
B1-11-0-ST |
|--|---|---|---|---|--|

For Optional Culinary Tools see pages 85-90

† The Upper Deck requires a 1/4" clearance below the surface of the countertop. If the countertop thickness is 3/4" or less, Walnut or Bamboo Upper Deck sections will not have the clearance to function above the Upper Tier Culinary Tools.

Upper Deck.

Cover set UD-3-18-3P-WA/GT/BA/GR/WH Walnut, Graphite, Bamboo, Gray or White Resin

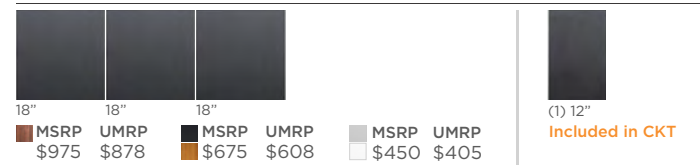

18" MSRP UMRP \$975 \$878	18" MSRP UMRP \$675 \$608	18" MSRP UMRP \$450 \$405	(1) 12" Included in CKT
------------------------------	------------------------------	------------------------------	-------------------------

Sections Walnut, Graphite, Bamboo, Gray or White Resin



Upper Deck Sections			
UD-18-l MSRP UMRP WA \$325 \$293 GT/BA \$225 \$203 GR/WH \$150 \$135	UD-09-l MSRP UMRP WA \$275 \$248 GT/BA \$175 \$158 GR/WH \$100 \$90	UD-12-l MSRP UMRP WA \$300 \$270 GT/BA \$200 \$180 GR/WH \$125 \$113	UD-06-l MSRP UMRP WA \$275 \$248 GT/BA \$175 \$158 GR/WH \$100 \$90

Specifications

Single bowl
Users: 1
Culinary Tools included: Five
DryDock Tool included: One
Galley Tap recommended: One
Outside dimensions: 51 1/2" x 19 1/2" x 2 1/16"
Interior dimensions: 50" x 17" x 2"
Countertop cutout: 50 1/2" x 18"
Minimum cabinet size: 54" or 135cm
Minimum clearance required for DryDock below countertop: 2"
DryDock location: Drain side (S)

Basin (KSO-3-S-DS-18-S-SS)

16GA 316L stainless steel indoor/outdoor
SilentArmor™ sound reduction technology
Angel finish
Three tier design
Star™ groove pattern
Reversible side drain
Drain cover included
Limited Lifetime Warranty
Made in the USA
ASME A112.19.3/CSA B45.4 certified
cUPC™ certified

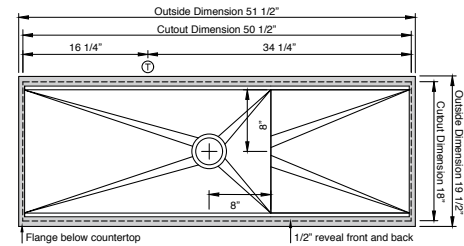

Center Galley Tap holes 2" from the back of the 18" countertop cutout

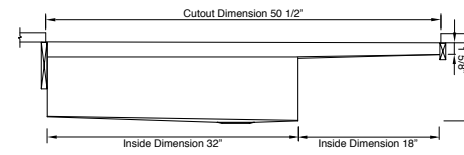

Important Installation Note: DryDock requires 2" minimum clearance below countertop

Customize Your Galley

Add 7-12" length	\$1,200	p. 80	9" depth	\$300	p. 80
Add 1-6" length	\$900	p. 80	Center drain	\$300	p. 80
Add 18" DryDock	\$1,800	p. 79	ThinTop™	\$500	p. 79
Add 12" DryDock	\$1,500	p. 79	WorkTop™	Custom	
Apron front	\$2,100	p. 79	*Color coded labels available		p. 87

DryDock Tool included (DR-18)



- | |
|--|
| (1) Dual Tier Drying Rack
18" x 17"
DR-18-D-xx |
|--|

For Galley Tap Suite see pages 93-112
For Freight see page 117

Recommended Basin Accessories & citrine.

Bottom Grate set BG-3-S-1-SS Stainless Steel

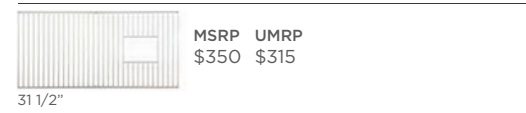

MSRP UMRP
\$350 \$315

Strainer M-DRN-MSS
Angel Finish 304 Stainless Steel



MSRP \$110
UMRP \$99

Disposal Strainer G-DRN-MSS
Angel Finish 304 Stainless Steel



MSRP \$110
UMRP \$99

Auto Strainer Angel Finish 304 Stainless Steel with Polished or Matte knob



A-DRN-PSS MSRP \$240 UMRP \$216
A-DRN-MSS MSRP \$220 UMRP \$198

CIT-09-SS-C
Stainless Steel
Clean + Polish 9 oz
MSRP UMRP
\$33 \$30

CIT-09-WD-C
Wood Condition + Protect 9 oz
MSRP UMRP
\$25 \$23

CIT-04-WD-B
Wood Finishing Balm 4 oz
MSRP UMRP
\$22 \$20

Ideal Workstation. 3S + DryDock. 12

IWS-3-S-DD-12-S-WA



MSRP \$6,120
UMRP \$5,508

American Black Walnut

IWS-3-S-DD-12-S-GT



MSRP \$5,670
UMRP \$5,103

Graphite Wood Composite

IWS-3-S-DD-12-S-BA



MSRP \$5,670
UMRP \$5,103

Natural Golden Bamboo

IWS-3-S-DD-12-S-GR



MSRP \$5,320
UMRP \$4,788

Exclusive Gray Resin*

IWS-3-S-DD-12-S-WH



MSRP \$5,320
UMRP \$4,788

Designer White Resin*

Culinary Tools included (CKT-12)

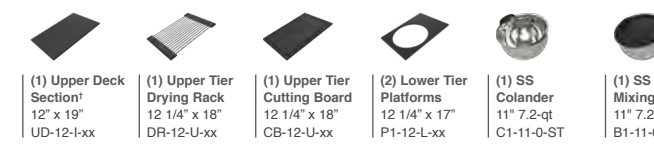

- | | | | | | |
|--|---|---|---|---|--|
| (1) Upper Deck Section†
12" x 19"
UD-12-l-xx | (1) Upper Tier Drying Rack
12 1/4" x 18"
DR-12-U-xx | (1) Upper Tier Cutting Board
12 1/4" x 18"
CB-12-U-xx | (2) Lower Tier Platforms
12 1/4" x 17"
P1-12-L-xx | (1) SS Colander
11" 7.2-qt
C1-11-0-ST | (1) SS Mixing Bowl
11" 7.2-qt
B1-11-0-ST |
|--|---|---|---|---|--|

For Optional Culinary Tools see pages 85-90

† The Upper Deck requires a 1/4" clearance below the surface of the countertop. If the countertop thickness is 3/4" or less, Walnut or Bamboo Upper Deck sections will not have the clearance to function above the Upper Tier Culinary Tools.

Upper Deck.

Cover set UD-3-12-3P-WA/GT/BA/GR/WH Walnut, Graphite, Bamboo, Gray or White Resin

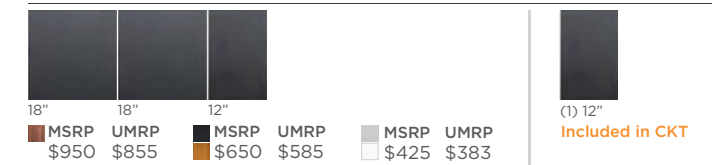

18" MSRP UMRP \$950 \$855	18" MSRP UMRP \$650 \$585	12" MSRP UMRP \$425 \$383	(1) 12" Included in CKT
------------------------------	------------------------------	------------------------------	-------------------------

Sections Walnut, Graphite, Bamboo, Gray or White Resin

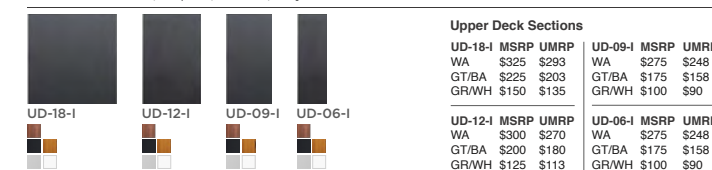

Upper Deck Sections			
UD-18-l MSRP UMRP WA \$325 \$293 GT/BA \$225 \$203 GR/WH \$150 \$135	UD-09-l MSRP UMRP WA \$275 \$248 GT/BA \$175 \$158 GR/WH \$100 \$90	UD-12-l MSRP UMRP WA \$300 \$270 GT/BA \$200 \$180 GR/WH \$125 \$113	UD-06-l MSRP UMRP WA \$275 \$248 GT/BA \$175 \$158 GR/WH \$100 \$90

Specifications

Single bowl
Users: 1
Culinary Tools included: Five
DryDock Tool included: One
Galley Tap recommended: One
Outside dimensions: 45 1/2" x 19 1/2" x 2 1/16"
Interior dimensions: 44" x 17" x 2"
Countertop cutout: 44 1/2" x 18"
Minimum cabinet size: 48" or 120cm
Minimum clearance required for DryDock below countertop: 2"
DryDock location: Drain side (S)

Basin (KSO-3-S-DS-12-S-SS)

16GA 316L stainless steel indoor/outdoor
SilentArmor™ sound reduction technology
Angel finish
Three tier design
Star™ groove pattern
Reversible side drain
Drain cover included
Limited Lifetime Warranty
Made in the USA
ASME A112.19.3/CSA B45.4 certified
cUPC™ certified

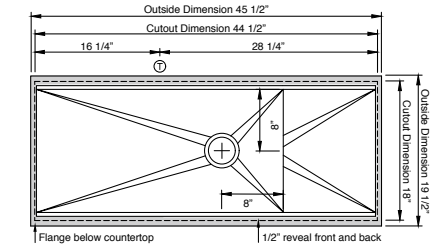

Center Galley Tap holes 2" from the back of the 18" countertop cutout

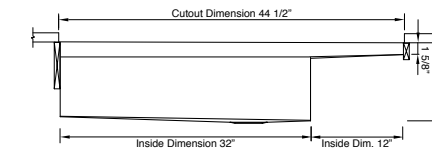

Important Installation Note: DryDock requires 2" minimum clearance below countertop

Customize Your Galley

Add 7-12" length	\$1,200	p. 80	9" depth	\$300	p. 80
Add 1-6" length	\$900	p. 80	Center drain	\$300	p. 80
Add 18" DryDock	\$1,800	p. 79	ThinTop™	\$500	p. 79
Add 12" DryDock	\$1,500	p. 79	WorkTop™	Custom	
Apron front	\$2,100	p. 79	*Color coded labels available		p. 87

DryDock Tool included (DR-12)



- | |
|---|
| (1) Lower Tier Drying Rack
12 1/4" x 17"
DR-12-L-xx |
|---|

For Galley Tap Suite see pages 93-112
For Freight see page 117

Recommended Basin Accessories & citrine.

Bottom Grate set BG-3-S-1-SS Stainless Steel

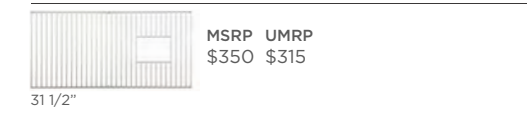

MSRP UMRP
\$350 \$315

Strainer M-DRN-MSS
Angel Finish 304 Stainless Steel



MSRP \$110
UMRP \$99

Disposal Strainer G-DRN-MSS
Angel Finish 304 Stainless Steel



MSRP \$110
UMRP \$99

Auto Strainer Angel Finish 304 Stainless Steel with Polished or Matte knob



A-DRN-PSS MSRP \$240 UMRP \$216
A-DRN-MSS MSRP \$220 UMRP \$198

CIT-09-SS-C
Stainless Steel
Clean + Polish 9 oz
MSRP UMRP
\$33 \$30

CIT-09-WD-C
Wood Condition + Protect 9 oz
MSRP UMRP
\$25 \$23

CIT-04-WD-B
Wood Finishing Balm 4 oz
MSRP UMRP
\$22 \$20

Ideal Workstation. 30S + DryDock. 18

IWS-30-S-DD-18-S-WA

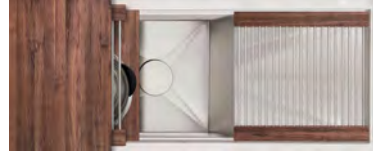

MSRP \$6,170
UMRP \$5,553

American Black Walnut

IWS-30-S-DD-18-S-GT

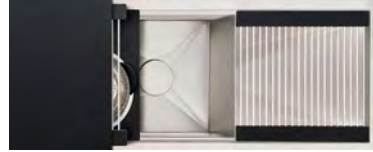

MSRP \$5,720
UMRP \$5,148

Graphite Wood Composite

IWS-30-S-DD-18-S-BA

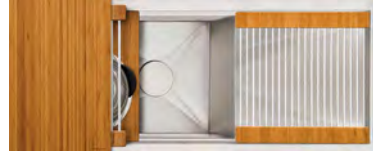

MSRP \$5,720
UMRP \$5,148

Natural Golden Bamboo

IWS-30-S-DD-18-S-GR



MSRP \$5,345
UMRP \$4,811

Exclusive Gray Resin*

IWS-30-S-DD-18-S-WH



MSRP \$5,345
UMRP \$4,811

Designer White Resin*

Culinary Tools included (CKT-12)

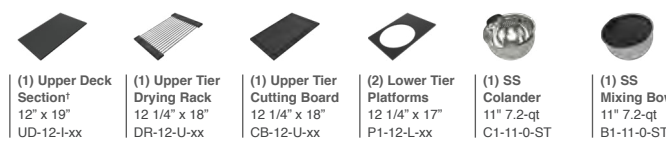

(1) Upper Deck Section† 12" x 19" UD-12-L-xx	(1) Upper Tier Drying Rack 12 1/4" x 18" DR-12-U-xx	(1) Upper Tier Cutting Board 12 1/4" x 18" CB-12-U-xx	(2) Lower Tier Platforms 12 1/4" x 17" P1-12-L-xx	(1) SS Colander 11" 7.2-qt C1-11-0-ST	(1) SS Mixing Bowl 11" 7.2-qt B1-11-0-ST
--	---	---	---	---	--

For Optional Culinary Tools see pages 85-90

† The Upper Deck requires a 1/4" clearance below the surface of the countertop. If the countertop thickness is 3/4" or less, Walnut or Bamboo Upper Deck sections will not have the clearance to function above the Upper Tier Culinary Tools.

Upper Deck.

Cover set UD-30-18-3P-WA/GT/BA/GR/WH Walnut, Graphite, Bamboo, Gray or White Resin

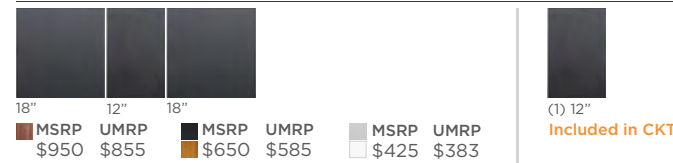

18"	12"	18"	(1) 12"
MSRP UMRP \$950 \$855	MSRP UMRP \$650 \$585	MSRP UMRP \$425 \$383	Included in CKT

Sections Walnut, Graphite, Bamboo, Gray or White Resin

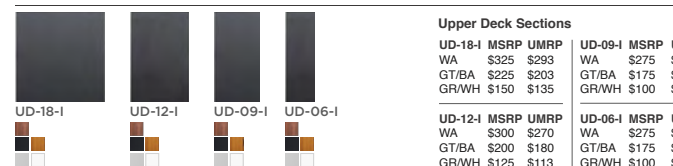

Upper Deck Sections			
UD-18-I	MSRP UMRP \$300 \$270	UD-09-I	MSRP UMRP \$275 \$248
WA	\$325 \$293	WA	\$275 \$248
GT/BA	\$225 \$203	GT/BA	\$175 \$158
GR/WH	\$150 \$135	GR/WH	\$100 \$90
UD-12-I	MSRP UMRP \$300 \$270	UD-06-I	MSRP UMRP \$275 \$248
WA	\$325 \$293	WA	\$275 \$248
GT/BA	\$200 \$180	GT/BA	\$175 \$158
GR/WH	\$125 \$113	GR/WH	\$100 \$90

Specifications

Single bowl
Users: 1
Culinary Tools included: Five
DryDock Tool included: One
Galley BarTap, recommended: One
Star™ groove pattern
Outside dimensions: 45 1/2" x 19 1/2" x 2 1/16"
Interior dimensions: 44" x 17" x 2"
Countertop cutout: 44 1/2" x 18"
Minimum cabinet size: 48" or 120cm
Minimum clearance required for DryDock below countertop: 2"
DryDock location: Drain side (S)

Basin (KSO-30-S-DS-18-S-SS)

16GA 316L stainless steel indoor/outdoor
SilentArmor™ sound reduction technology
Angel finish
Three tier design
Star™ groove pattern
Reversible side drain
Drain cover included
Limited Lifetime Warranty
Made in the USA
ASME A112.19.3/CSA B45.4 certified
cUPC™ certified

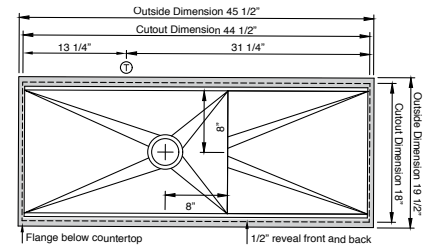

Center Galley Tap holes 2" from the back of the 18" countertop cutout

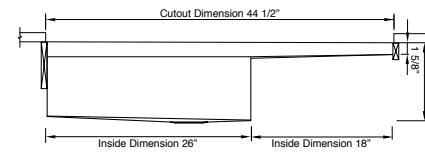

Important Installation Note: DryDock requires 2" minimum clearance below countertop

Customize Your Galley

Add 7-12" length	\$1,200	p. 80	9" depth	\$300	p. 80
Add 1-6" length	\$900	p. 80	Center drain	\$300	p. 80
Add 18" DryDock	\$1,800	p. 79	ThinTop™	\$500	p. 79
Add 12" DryDock	\$1,500	p. 79	WorkTop™	Custom	p. 79
Apron front	\$2,000	p. 79	*Color coded labels available		p. 87

DryDock Tool included (DR-18)



(1) Dual Tier Drying Rack
18" x 17"
DR-18-D-xx

For Galley Tap Suite see pages 93-112
For Freight see page 117

Recommended Basin Accessories & citrine.

Bottom Grate set BG-30-S-1-SS Stainless Steel

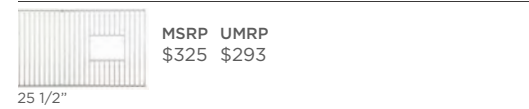

25 1/2"	MSRP UMRP \$325 \$293
---------	--------------------------

Strainer M-DRN-MSS
Angel Finish 304 Stainless Steel



MSRP \$110
UMRP \$99

Disposal Strainer G-DRN-MSS
Angel Finish 304 Stainless Steel

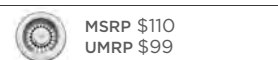

MSRP \$110
UMRP \$99

Auto Strainer Angel Finish 304 Stainless Steel with Polished or Matte knob



A-DRN-PSS MSRP \$240 UMRP \$216
A-DRN-MSS MSRP \$220 UMRP \$198

CIT-09-SS-C
Stainless Steel
Clean + Polish 9 oz
MSRP UMRP
\$33 \$30

CIT-09-WD-C
Wood Condition + Protect 9 oz
MSRP UMRP
\$25 \$23

CIT-04-WD-B
Wood Finishing Balm 4 oz
MSRP UMRP
\$22 \$20

Ideal Workstation. 30S + DryDock. 12

IWS-30-S-DD-12-S-WA



MSRP \$5,820
UMRP \$5,238

American Black Walnut

IWS-30-S-DD-12-S-GT



MSRP \$5,370
UMRP \$4,833

Graphite Wood Composite

IWS-30-S-DD-12-S-BA



MSRP \$5,370
UMRP \$4,833

Natural Golden Bamboo

IWS-30-S-DD-12-S-GR

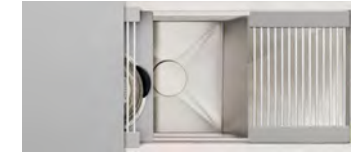

MSRP \$5,020
UMRP \$4,518

Exclusive Gray Resin*

IWS-30-S-DD-12-S-WH



MSRP \$5,020
UMRP \$4,518

Designer White Resin*

Culinary Tools included (CKT-12)

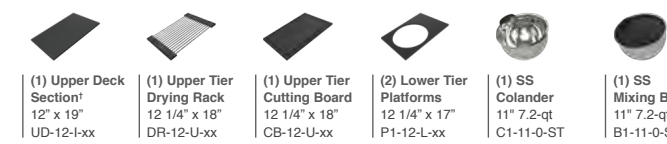

(1) Upper Deck Section† 12" x 19" UD-12-L-xx	(1) Upper Tier Drying Rack 12 1/4" x 18" DR-12-U-xx	(1) Upper Tier Cutting Board 12 1/4" x 18" CB-12-U-xx	(2) Lower Tier Platforms 12 1/4" x 17" P1-12-L-xx	(1) SS Colander 11" 7.2-qt C1-11-0-ST	(1) SS Mixing Bowl 11" 7.2-qt B1-11-0-ST
--	---	---	---	---	--

For Optional Culinary Tools see pages 85-90

† The Upper Deck requires a 1/4" clearance below the surface of the countertop. If the countertop thickness is 3/4" or less, Walnut or Bamboo Upper Deck sections will not have the clearance to function above the Upper Tier Culinary Tools.

Upper Deck.

Cover set UD-30-12-3P-WA/GT/BA/GR/WH Walnut, Graphite, Bamboo, Gray or White Resin

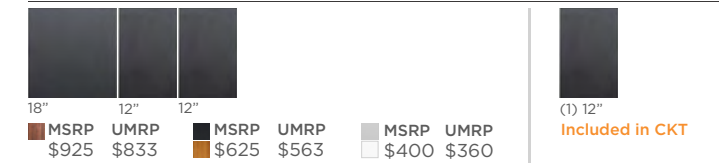

18"	12"	12"	(1) 12"
MSRP UMRP \$925 \$833	MSRP UMRP \$625 \$563	MSRP UMRP \$400 \$360	Included in CKT

Sections Walnut, Graphite, Bamboo, Gray or White Resin

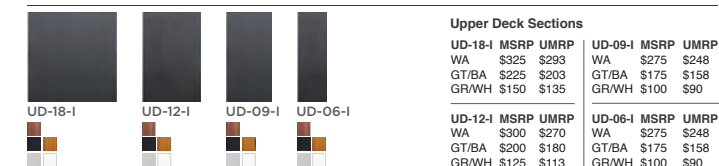

Upper Deck Sections			
UD-18-I	MSRP UMRP \$300 \$270	UD-09-I	MSRP UMRP \$275 \$248
WA	\$325 \$293	WA	\$275 \$248
GT/BA	\$225 \$203	GT/BA	\$175 \$158
GR/WH	\$150 \$135	GR/WH	\$100 \$90
UD-12-I	MSRP UMRP \$300 \$270	UD-06-I	MSRP UMRP \$275 \$248
WA	\$325 \$293	WA	\$275 \$248
GT/BA	\$200 \$180	GT/BA	\$175 \$158
GR/WH	\$125 \$113	GR/WH	\$100 \$90

Specifications

Single bowl
Users: 1
Culinary Tools included: Five
DryDock Tool included: One
Galley BarTap, recommended: One
Star™ groove pattern
Outside dimensions: 39 1/2" x 19 1/2" x 2 1/16"
Interior dimensions: 38" x 17" x 2"
Countertop cutout: 38 1/2" x 18"
Minimum cabinet size: 42" or 107cm
Minimum clearance required for DryDock below countertop: 2"
DryDock location: Drain side (S)

Basin (KSO-30-S-DS-12-S-SS)

16GA 316L stainless steel indoor/outdoor
SilentArmor™ sound reduction technology
Angel finish
Three tier design
Star™ groove pattern
Reversible side drain
Drain cover included
Limited Lifetime Warranty
Made in the USA
ASME A112.19.3/CSA B45.4 certified
cUPC™ certified

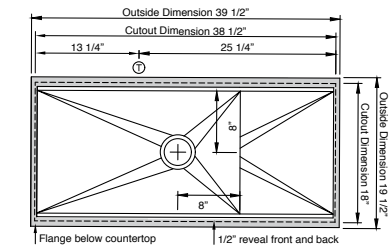

Center Galley Tap holes 2" from the back of the 18" countertop cutout

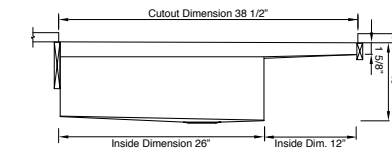

Important Installation Note: DryDock requires 2" minimum clearance below countertop

Customize Your Galley

Add 7-12" length	\$1,200	p. 80	9" depth	\$300	p. 80
Add 1-6" length	\$900	p. 80	Center drain	\$300	p. 80
Add 18" DryDock	\$1,800	p. 79	ThinTop™	\$500	p. 79
Add 12" DryDock	\$1,500	p. 79	WorkTop™	Custom	p. 79
Apron front	\$2,000	p. 79	*Color coded labels available		p. 87

DryDock Tool included (DR-12)



(1) Lower Tier Drying Rack
12 1/4" x 17"
DR-12-L-xx

For Galley Tap Suite see pages 93-112
For Freight see page 117

Recommended Basin Accessories & citrine.

Bottom Grate set BG-30-S-1-SS Stainless Steel

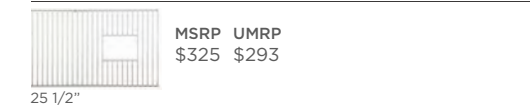

25 1/2"	MSRP UMRP \$325 \$293
---------	--------------------------

Strainer M-DRN-MSS
Angel Finish 304 Stainless Steel



MSRP \$110
UMRP \$99

Disposal Strainer G-DRN-MSS
Angel Finish 304 Stainless Steel

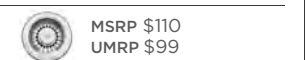

MSRP \$110
UMRP \$99

Auto Strainer Angel Finish 304 Stainless Steel with Polished or Matte knob



A-DRN-PSS MSRP \$240 UMRP \$216
A-DRN-MSS MSRP \$220 UMRP \$198

CIT-09-SS-C
Stainless Steel
Clean + Polish 9 oz
MSRP UMRP
\$33 \$30

CIT-09-WD-C
Wood Condition + Protect 9 oz
MSRP UMRP
\$25 \$23

CIT-04-WD-B
Wood Finishing Balm 4 oz
MSRP UMRP
\$22 \$20

Ideal WashStation™ 4S + DryDock® 18

IWA-4-S-DD-18-S-WA



MSRP \$6,870
UMRP \$6,183

American Black Walnut / Graphite Resin+

IWA-4-S-DD-18-S-GT



MSRP \$6,720
UMRP \$6,048

Graphite Wood Composite / Graphite Resin+

IWA-4-S-DD-18-S-BA



MSRP \$6,720
UMRP \$6,048

Natural Golden Bamboo / Exclusive Gray Resin+

IWA-4-S-DD-18-S-GR



MSRP \$6,545
UMRP \$5,891

Exclusive Gray Resin+ / Resin+

IWA-4-S-DD-18-S-WH



MSRP \$6,545
UMRP \$5,891

Designer White Resin+ / Resin+

Wash Tools included (WKT-4T)



(1) Upper Tier Drying Rack 9 1/4" x 18" DR-09-U-xx
(1) Lower Tier Wash Caddy 6" x 17" WC-06-L-xx
(1) Lower Tier Wash Bowl 12" x 17" WB-12-L-xx
(1) Upper Tier Utensil Caddy 6" x 18" UC-06-U-xx

For Optional Culinary Tools see pages 85-90

Upper Deck.

Cover set UD-4-18-3P-WA/GT/BA/GR/WH Walnut, Graphite, Bamboo, Gray or White Resin

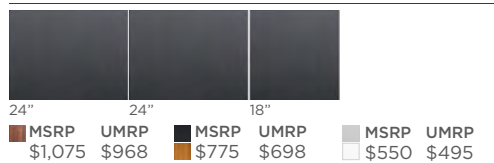

MSRP UMRP MSRP UMRP MSRP UMRP MSRP UMRP MSRP UMRP
\$1,075 \$968 \$775 \$698 \$550 \$495

Sections Walnut, Graphite, Bamboo, Gray or White Resin

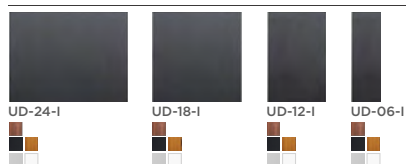

Upper Deck Sections
UD-24-1 MSRP UMRP WA \$375 \$338 GT/BA \$275 \$248 GR/WH \$200 \$180
UD-18-1 MSRP UMRP WA \$325 \$293 GT/BA \$225 \$203 GR/WH \$150 \$135
UD-12-1 MSRP UMRP WA \$300 \$270 GT/BA \$200 \$180 GR/WH \$125 \$113
UD-06-1 MSRP UMRP WA \$275 \$248 GT/BA \$175 \$158 GR/WH \$100 \$90

Specifications

Single bowl
Users: 1
Wash Tools included: Four
DryDock Tool included: One
Galley Tap recommended: One
Outside dimensions: 63 1/2" x 19 1/2" x 2 1/16"
Interior dimensions: 62" x 17" x 2"
Countertop cutout: 62 1/2" x 18"
Minimum cabinet size: 66" or 165cm
Minimum clearance required for DryDock below countertop: 2"
DryDock location: Drain side (S)

Basin (KSO-4-S-DS-18-S-SS)

16GA 316L stainless steel indoor/outdoor
SilentArmor™ sound reduction technology
Angel finish
Three tier design
Star™ groove pattern
Reversible side drain
Drain cover included
Limited Lifetime Warranty
Made in the USA
ASME A112.19.3/CSA B45.4 certified
cUPC™ certified

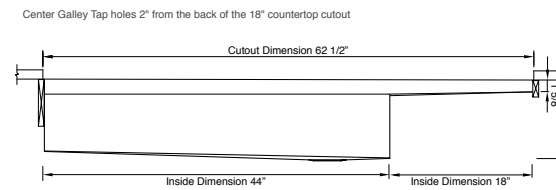
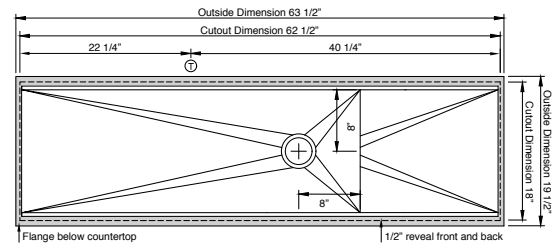

Important Installation Note: DryDock requires 2" minimum clearance below countertop

Customize Your Galley

Add 7-12" length	\$1,200	p. 80	9" depth	\$300	p. 80
Add 1-6" length	\$900	p. 80	Center drain	\$300	p. 80
Add 18" DryDock	\$1,800	p. 79	ThinTop™	\$500	p. 79
Add 12" DryDock	\$1,500	p. 79	WorkTop™	Custom	p. 79
Apron front	\$2,300	p. 79	*Color coded labels available		p. 87

DryDock Tool included (DR-18)



(1) Dual Tier Drying Rack 18" x 17" DR-18-D-xx

For Galley Tap Suite see pages 93-112
For Freight see page 117

Recommended Basin Accessories & citrine.

Bottom Grate set BG-4-S-2-SS Stainless Steel



MSRP UMRP
\$600 \$540

Strainer M-DRN-MSS Angel Finish 304 Stainless Steel MSRP \$110 UMRP \$99
Disposal Strainer G-DRN-MSS Angel Finish 304 Stainless Steel MSRP \$110 UMRP \$99

Auto Strainer Angel Finish 304 Stainless Steel with Polished or Matte knob
A-DRN-PSS MSRP \$240 UMRP \$216
A-DRN-MSS MSRP \$220 UMRP \$198

CIT-09-SS-C Stainless Steel Clean + Polish 9 oz MSRP \$33 UMRP \$30
CIT-09-WD-C Wood Condition + Protect 9 oz MSRP \$25 UMRP \$23
CIT-04-WD-B Wood Finishing Balm 4 oz MSRP \$22 UMRP \$20

Ideal WashStation™ 4S + DryDock® 12

IWA-4-S-DD-12-S-WA



MSRP \$6,520
UMRP \$5,868

American Black Walnut / Graphite Resin+

IWA-4-S-DD-12-S-GT



MSRP \$6,370
UMRP \$5,733

Graphite Wood Composite / Graphite Resin+

IWA-4-S-DD-12-S-BA



MSRP \$6,370
UMRP \$5,733

Natural Golden Bamboo / Exclusive Gray Resin+

IWA-4-S-DD-12-S-GR



MSRP \$6,220
UMRP \$5,598

Exclusive Gray Resin+ / Resin+

IWA-4-S-DD-12-S-WH



MSRP \$6,220
UMRP \$5,598

Designer White Resin+ / Resin+

Wash Tools included (WKT-4T)



(1) Upper Tier Drying Rack 9 1/4" x 18" DR-09-U-xx
(1) Lower Tier Wash Caddy 6" x 17" WC-06-L-xx
(1) Lower Tier Wash Bowl 12" x 17" WB-12-L-xx
(1) Upper Tier Utensil Caddy 6" x 18" UC-06-U-xx

For Optional Culinary Tools see pages 85-90

Upper Deck.

Cover set UD-4-12-3P-WA/GT/BA/GR/WH Walnut, Graphite, Bamboo, Gray or White Resin

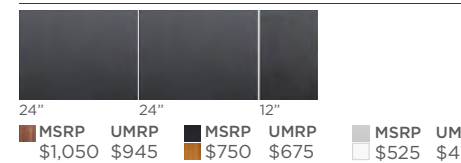

MSRP UMRP MSRP UMRP MSRP UMRP MSRP UMRP MSRP UMRP
\$1,050 \$945 \$750 \$675 \$525 \$473

Sections Walnut, Graphite, Bamboo, Gray or White Resin



Upper Deck Sections
UD-24-1 MSRP UMRP WA \$375 \$338 GT/BA \$275 \$248 GR/WH \$200 \$180
UD-12-1 MSRP UMRP WA \$300 \$270 GT/BA \$200 \$180 GR/WH \$125 \$113

Specifications

Single bowl
Users: 1
Wash Tools included: Four
DryDock Tool included: One
Galley Tap recommended: One
Outside dimensions: 57 1/2" x 19 1/2" x 2 1/16"
Interior dimensions: 56" x 17" x 2"
Countertop cutout: 56 1/2" x 18"
Minimum cabinet size: 60" or 150cm
Minimum clearance required for DryDock below countertop: 2"
DryDock location: Drain side (S)

Basin (KSO-4-S-DS-12-S-SS)

16GA 316L stainless steel indoor/outdoor
SilentArmor™ sound reduction technology
Angel finish
Three tier design
Star™ groove pattern
Reversible side drain
Drain cover included
Limited Lifetime Warranty
Made in the USA
ASME A112.19.3/CSA B45.4 certified
cUPC™ certified

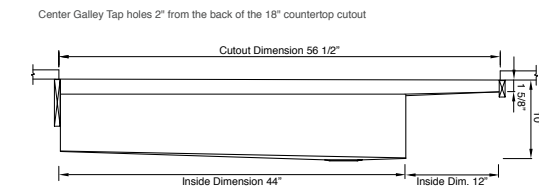
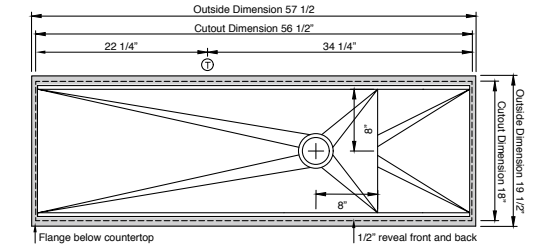

Important Installation Note: DryDock requires 2" minimum clearance below countertop

Customize Your Galley

Add 7-12" length	\$1,200	p. 80	9" depth	\$300	p. 80
Add 1-6" length	\$900	p. 80	Center drain	\$300	p. 80
Add 18" DryDock	\$1,800	p. 79	ThinTop™	\$500	p. 79
Add 12" DryDock	\$1,500	p. 79	WorkTop™	Custom	p. 79
Apron front	\$2,300	p. 79	*Color coded labels available		p. 87

DryDock Tool included (DR-12)



(1) Lower Tier Drying Rack 12 1/4" x 17" DR-12-L-xx

For Galley Tap Suite see pages 93-112
For Freight see page 117

Recommended Basin Accessories & citrine.

Bottom Grate set BG-4-S-2-SS Stainless Steel



MSRP UMRP
\$600 \$540

Strainer M-DRN-MSS Angel Finish 304 Stainless Steel MSRP \$110 UMRP \$99
Disposal Strainer G-DRN-MSS Angel Finish 304 Stainless Steel MSRP \$110 UMRP \$99

Auto Strainer Angel Finish 304 Stainless Steel with Polished or Matte knob
A-DRN-PSS MSRP \$240 UMRP \$216
A-DRN-MSS MSRP \$220 UMRP \$198

CIT-09-SS-C Stainless Steel Clean + Polish 9 oz MSRP \$33 UMRP \$30
CIT-09-WD-C Wood Condition + Protect 9 oz MSRP \$25 UMRP \$23
CIT-04-WD-B Wood Finishing Balm 4 oz MSRP \$22 UMRP \$20

Ideal WashStation™ 3S + DryDock® 18

IWA-3-S-DD-18-S-WA



MSRP \$5,870
UMRP \$5,283

American Black Walnut / Graphite Resin+

IWA-3-S-DD-18-S-GT



MSRP \$5,720
UMRP \$5,148

Graphite Wood Composite / Graphite Resin+

IWA-3-S-DD-18-S-BA



MSRP \$5,720
UMRP \$5,148

Natural Golden Bamboo / Exclusive Gray Resin+

IWA-3-S-DD-18-S-GR



MSRP \$5,545
UMRP \$4,991

Exclusive Gray Resin* / Resin+

IWA-3-S-DD-18-S-WH



MSRP \$5,545
UMRP \$4,991

Designer White Resin* / Resin+

Wash Tools included (WKT-4T)



- (1) Upper Tier Drying Rack 9 1/4" x 18" DR-09-U-xx
- (1) Lower Tier Wash Caddy 6" x 17" WC-06-L-xx
- (1) Lower Tier Wash Bowl 12" x 17" WB-12-L-xx
- (1) Upper Tier Utensil Caddy 6" x 18" UC-06-U-xx

For Optional Culinary Tools see pages 85-90

Upper Deck.

Cover set UD-3-18-3P-WA/GT/BA/GR/WH Walnut, Graphite, Bamboo, Gray or White Resin

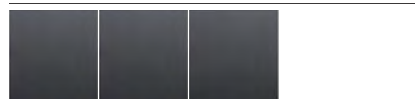

MSRP UMRP MSRP UMRP MSRP UMRP
\$975 \$878 \$675 \$608 \$450 \$405

Sections Walnut, Graphite, Bamboo, Gray or White Resin

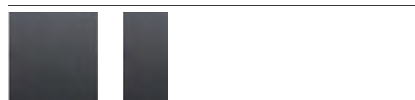

MSRP UMRP MSRP UMRP MSRP UMRP MSRP UMRP
UD-18-I \$325 \$293 UD-09-I \$275 \$248
GT/BA \$225 \$203 GR/WH \$150 \$135
UD-09-I MSRP UMRP
WA \$275 \$248
GT/BA \$175 \$158
GR/WH \$100 \$90

Specifications

Single bowl
Users: 1
Wash Tools included: Four
DryDock Tool included: One
Galley Tap recommended: One
Outside dimensions: 51 1/2" x 19 1/2" x 2 1/16"
Interior dimensions: 50" x 17" x 2"
Countertop cutout: 50 1/2" x 18"
Minimum cabinet size: 54" or 135cm
Minimum clearance required for DryDock below countertop: 2"
DryDock location: Drain side (S)

Basin (KSO-3-S-DS-18-S-SS)

16GA 316L stainless steel indoor/outdoor
SilentArmor™ sound reduction technology
Angel finish
Three tier design
Star™ groove pattern
Reversible side drain
Drain cover included
Limited Lifetime Warranty
Made in the USA
ASME A112.19.3/CSA B45.4 certified
cUPC™ certified

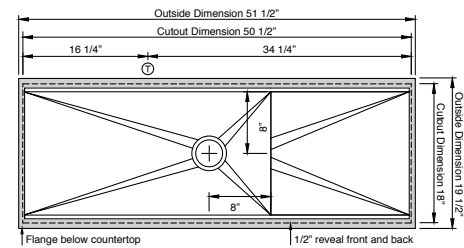

Center Galley Tap holes 2" from the back of the 18" countertop cutout

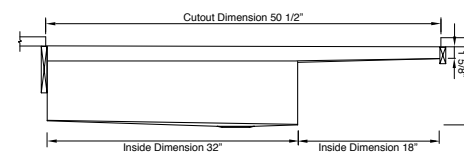

Important Installation Note: DryDock requires 2" minimum clearance below countertop

Customize Your Galley

Add 7-12" length	\$1,200	p. 80	9" depth	\$300	p. 80
Add 1-6" length	\$900	p. 80	Center drain	\$300	p. 80
Add 18" DryDock	\$1,800	p. 79	ThinTop™	\$500	p. 79
Add 12" DryDock	\$1,500	p. 79	WorkTop™	Custom	p. 79
Apron front	\$2,100	p. 79	*Color coded labels available		p. 87

DryDock Tool included (DR-18)



- (1) Dual Tier Drying Rack 18" x 17" DR-18-D-xx

For Galley Tap Suite see pages 93-112
For Freight see page 117

Recommended Basin Accessories & citrine.

Bottom Grate set BG-3-S-1-SS Stainless Steel



MSRP UMRP
\$350 \$315

Strainer M-DRN-MSS Angel Finish 304 Stainless Steel
MSRP \$110 UMRP \$99

Disposal Strainer G-DRN-MSS Angel Finish 304 Stainless Steel
MSRP \$110 UMRP \$99

Auto Strainer Angel Finish 304 Stainless Steel with Polished or Matte knob

MSRP UMRP MSRP UMRP MSRP UMRP
A-DRN-PSS \$240 \$216
A-DRN-MSS \$220 \$198

CIT-09-SS-C Stainless Steel Clean + Polish 9 oz
MSRP UMRP \$33 \$30

CIT-09-WD-C Wood Condition + Protect 9 oz
MSRP UMRP \$25 \$23

CIT-04-WD-B Wood Finishing Balm 4 oz
MSRP UMRP \$22 \$20

Ideal WashStation™ 3S + DryDock® 12

IWA-3-S-DD-12-S-WA



MSRP \$5,520
UMRP \$4,968

American Black Walnut / Graphite Resin+

IWA-3-S-DD-12-S-GT



MSRP \$5,370
UMRP \$4,833

Graphite Wood Composite / Graphite Resin+

IWA-3-S-DD-12-S-BA



MSRP \$5,370
UMRP \$4,833

Natural Golden Bamboo / Exclusive Gray Resin+

IWA-3-S-DD-12-S-GR



MSRP \$5,220
UMRP \$4,698

Exclusive Gray Resin* / Resin+

IWA-3-S-DD-12-S-WH



MSRP \$5,220
UMRP \$4,698

Designer White Resin* / Resin+

Wash Tools included (WKT-4T)



- (1) Upper Tier Drying Rack 9 1/4" x 18" DR-09-U-xx
- (1) Lower Tier Wash Caddy 6" x 17" WC-06-L-xx
- (1) Lower Tier Wash Bowl 12" x 17" WB-12-L-xx
- (1) Upper Tier Utensil Caddy 6" x 18" UC-06-U-xx

For Optional Culinary Tools see pages 85-90

Upper Deck.

Cover set UD-3-12-3P-WA/GT/BA/GR/WH Walnut, Graphite, Bamboo, Gray or White Resin

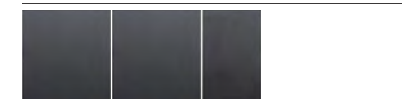

MSRP UMRP MSRP UMRP MSRP UMRP
\$950 \$855 \$650 \$585 \$425 \$383

Sections Walnut, Graphite, Bamboo, Gray or White Resin

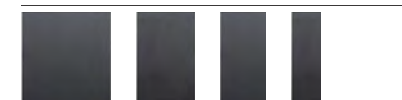

MSRP UMRP MSRP UMRP MSRP UMRP MSRP UMRP
UD-18-I \$325 \$293 UD-09-I \$275 \$248
GT/BA \$225 \$203 GR/WH \$150 \$135
UD-12-I \$300 \$270 UD-06-I \$275 \$248
GT/BA \$200 \$180 GT/BA \$175 \$158
GR/WH \$125 \$113 GR/WH \$100 \$90

Specifications

Single bowl
Users: 1
Wash Tools included: Four
DryDock Tool included: One
Galley Tap recommended: One
Outside dimensions: 45 1/2" x 19 1/2" x 2 1/16"
Interior dimensions: 44" x 17" x 2"
Countertop cutout: 44 1/2" x 18"
Minimum cabinet size: 48" or 120cm
Minimum clearance required for DryDock below countertop: 2"
DryDock location: Drain side (S)

Basin (KSO-3-S-DS-12-S-SS)

16GA 316L stainless steel indoor/outdoor
SilentArmor™ sound reduction technology
Angel finish
Three tier design
Star™ groove pattern
Reversible side drain
Drain cover included
Limited Lifetime Warranty
Made in the USA
ASME A112.19.3/CSA B45.4 certified
cUPC™ certified

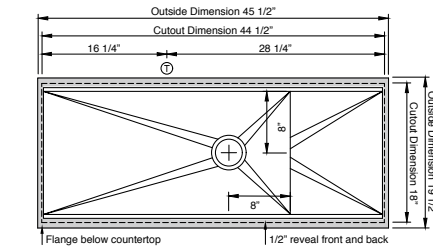

Center Galley Tap holes 2" from the back of the 18" countertop cutout

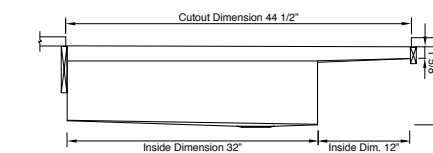

Important Installation Note: DryDock requires 2" minimum clearance below countertop

Customize Your Galley

Add 7-12" length	\$1,200	p. 80	9" depth	\$300	p. 80
Add 1-6" length	\$900	p. 80	Center drain	\$300	p. 80
Add 18" DryDock	\$1,800	p. 79	ThinTop™	\$500	p. 79
Add 12" DryDock	\$1,500	p. 79	WorkTop™	Custom	p. 79
Apron front	\$2,100	p. 79	*Color coded labels available		p. 87

DryDock Tool included (DR-12)



- (1) Lower Tier Drying Rack 12 1/4" x 17" DR-12-L-xx

For Galley Tap Suite see pages 93-112
For Freight see page 117

Recommended Basin Accessories & citrine.

Bottom Grate set BG-3-S-1-SS Stainless Steel

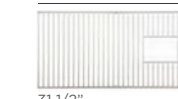

MSRP UMRP
\$350 \$315

Strainer M-DRN-MSS Angel Finish 304 Stainless Steel
MSRP \$110 UMRP \$99

Disposal Strainer G-DRN-MSS Angel Finish 304 Stainless Steel
MSRP \$110 UMRP \$99

Auto Strainer Angel Finish 304 Stainless Steel with Polished or Matte knob

MSRP UMRP MSRP UMRP MSRP UMRP MSRP UMRP
A-DRN-PSS \$240 \$216
A-DRN-MSS \$220 \$198

CIT-09-SS-C Stainless Steel Clean + Polish 9 oz
MSRP UMRP \$33 \$30

CIT-09-WD-C Wood Condition + Protect 9 oz
MSRP UMRP \$25 \$23

CIT-04-WD-B Wood Finishing Balm 4 oz
MSRP UMRP \$22 \$20

Ideal WashStation™ 30S + DryDock® 18

IWA-30-S-DD-18-S-WA



MSRP \$5,570
UMRP \$5,013

American Black Walnut / Graphite Resin+

IWA-30-S-DD-18-S-GT

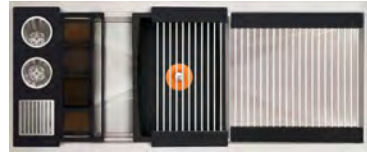

MSRP \$5,420
UMRP \$4,878

Graphite Wood Composite / Graphite Resin+

IWA-30-S-DD-18-S-BA

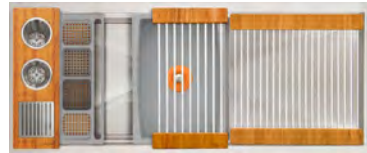

MSRP \$5,420
UMRP \$4,878

Natural Golden Bamboo / Exclusive Gray Resin+

IWA-30-S-DD-18-S-GR

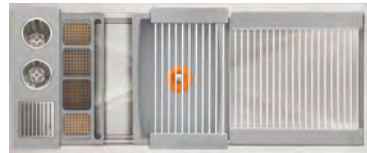

MSRP \$5,245
UMRP \$4,721

Exclusive Gray Resin+ / Resin+

IWA-30-S-DD-18-S-WH



MSRP \$5,245
UMRP \$4,721

Designer White Resin+ / Resin+

Wash Tools included (WKT-4T)



(1) Upper Tier Drying Rack
9 1/4" x 18"
DR-09-U-xx

(1) Lower Tier Wash Caddy
6" x 17"
WC-06-L-xx

(1) Lower Tier Wash Bowl
12" x 17"
WB-12-L-xx

(1) Upper Tier Utensil Caddy
6" x 18"
UC-06-U-xx

For Optional Culinary Tools see pages 85-90

Upper Deck.

Cover set UD-30-18-3P-WA/GT/BA/GR/WH Walnut, Graphite, Bamboo, Gray or White Resin

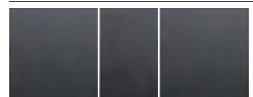

18"	12"	18"
MSRP UMRP	MSRP UMRP	MSRP UMRP
\$950 \$855	\$650 \$585	\$425 \$383

Sections Walnut, Graphite, Bamboo, Gray or White Resin



Upper Deck Sections			
UD-18-I	MSRP UMRP	UD-09-I	MSRP UMRP
WA	\$325 \$293	WA	\$275 \$248
GT/BA	\$225 \$203	GT/BA	\$175 \$158
GR/WH	\$150 \$135	GR/WH	\$100 \$90
UD-12-I	MSRP UMRP	UD-06-I	MSRP UMRP
WA	\$300 \$270	WA	\$275 \$248
GT/BA	\$200 \$180	GT/BA	\$175 \$158
GR/WH	\$125 \$113	GR/WH	\$100 \$90

Specifications

Single bowl
Users: 1
Wash Tools included: Four
DryDock Tool included: One
Galley BarTap, recommended: One
Outside dimensions: 45 1/2" x 19 1/2" x 2 1/16"
Interior dimensions: 44" x 17" x 2"
Countertop cutout: 44 1/2" x 18"
Minimum cabinet size: 48" or 120cm
Minimum clearance required for DryDock below countertop: 2"
DryDock location: Drain side (S)

Basin (KSO-30-S-DS-18-S-SS)

16GA 316L stainless steel indoor/outdoor
SilentArmor™ sound reduction technology
Angel finish
Three tier design
Star™ groove pattern
Reversible side drain
Drain cover included
Limited Lifetime Warranty
Made in the USA
ASME A112.19.3/CSA B45.4 certified
cUPC™ certified

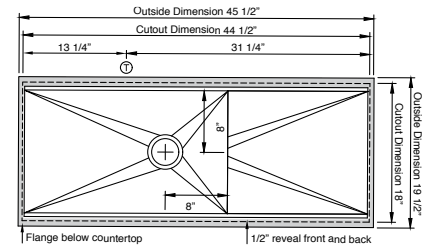

Center Galley Tap holes 2" from the back of the 18" countertop cutout

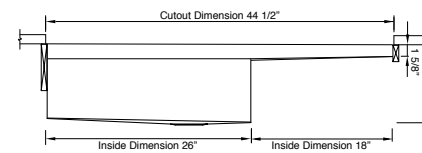

Important Installation Note: DryDock requires 2" minimum clearance below countertop

Customize Your Galley

Add 7-12" length	\$1,200	p. 80	9" depth	\$300	p. 80
Add 1-6" length	\$900	p. 80	Center drain	\$300	p. 80
Add 18" DryDock	\$1,800	p. 79	ThinTop™	\$500	p. 79
Add 12" DryDock	\$1,500	p. 79	WorkTop™	Custom	p. 79
Apron front	\$2,000	p. 79	*Color coded labels available		p. 87

DryDock Tool included (DR-18)



(1) Dual Tier Drying Rack
18" x 17"
DR-18-D-xx

For Galley Tap Suite see pages 93-112
For Freight see page 117

Recommended Basin Accessories & citrine.

Bottom Grate set BG-30-S-1-SS Stainless Steel



MSRP UMRP
\$325 \$293

Strainer M-DRN-MSS
Angel Finish 304 Stainless Steel



MSRP \$110
UMRP \$99

Disposal Strainer G-DRN-MSS
Angel Finish 304 Stainless Steel



MSRP \$110
UMRP \$99

Auto Strainer Angel Finish 304 Stainless Steel with Polished or Matte knob



A-DRN-PSS MSRP \$240 UMRP \$216
A-DRN-MSS MSRP \$220 UMRP \$198

CIT-09-SS-C
Stainless Steel
Clean + Polish 9 oz



MSRP UMRP
\$33 \$30

CIT-09-WD-C
Wood Condition + Protect 9 oz



MSRP UMRP
\$25 \$23

CIT-04-WD-B
Wood Finishing Balm 4 oz

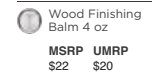

MSRP UMRP
\$22 \$20

Ideal WashStation™ 30S + DryDock® 12

IWA-30-S-DD-12-S-WA



MSRP \$5,220
UMRP \$4,698

American Black Walnut / Graphite Resin+

IWA-30-S-DD-12-S-GT



MSRP \$5,070
UMRP \$4,563

Graphite Wood Composite / Graphite Resin+

IWA-30-S-DD-12-S-BA

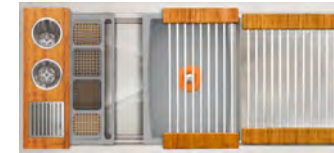

MSRP \$5,070
UMRP \$4,563

Natural Golden Bamboo / Exclusive Gray Resin+

IWA-30-S-DD-12-S-GR

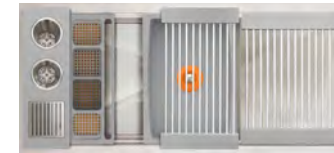

MSRP \$4,920
UMRP \$4,428

Exclusive Gray Resin+ / Resin+

IWA-30-S-DD-12-S-WH



MSRP \$4,920
UMRP \$4,428

Designer White Resin+ / Resin+

Wash Tools included (WKT-4T)



(1) Upper Tier Drying Rack
9 1/4" x 18"
DR-09-U-xx

(1) Lower Tier Wash Caddy
6" x 17"
WC-06-L-xx

(1) Lower Tier Wash Bowl
12" x 17"
WB-12-L-xx

(1) Upper Tier Utensil Caddy
6" x 18"
UC-06-U-xx

For Optional Culinary Tools see pages 85-90

Upper Deck.

Cover set UD-30-12-3P-WA/GT/BA/GR/WH Walnut, Graphite, Bamboo, Gray or White Resin

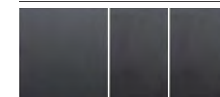

18"	12"	12"
MSRP UMRP	MSRP UMRP	MSRP UMRP
\$925 \$833	\$625 \$563	\$400 \$360

Sections Walnut, Graphite, Bamboo, Gray or White Resin



Upper Deck Sections			
UD-18-I	MSRP UMRP	UD-09-I	MSRP UMRP
WA	\$300 \$270	WA	\$275 \$248
GT/BA	\$225 \$203	GT/BA	\$175 \$158
GR/WH	\$150 \$135	GR/WH	\$100 \$90
UD-12-I	MSRP UMRP	UD-06-I	MSRP UMRP
WA	\$300 \$270	WA	\$275 \$248
GT/BA	\$200 \$180	GT/BA	\$175 \$158
GR/WH	\$125 \$113	GR/WH	\$100 \$90

Specifications

Single bowl
Users: 1
Wash Tools included: Four
DryDock Tool included: One
Galley BarTap, recommended: One
Outside dimensions: 39 1/2" x 19 1/2" x 2 1/16"
Interior dimensions: 38" x 17" x 2"
Countertop cutout: 38 1/2" x 18"
Minimum cabinet size: 42" or 107cm
Minimum clearance required for DryDock below countertop: 2"
DryDock location: Drain side (S)

Basin (KSO-30-S-DS-12-S-SS)

16GA 316L stainless steel indoor/outdoor
SilentArmor™ sound reduction technology
Angel finish
Three tier design
Star™ groove pattern
Reversible side drain
Drain cover included
Limited Lifetime Warranty
Made in the USA
ASME A112.19.3/CSA B45.4 certified
cUPC™ certified

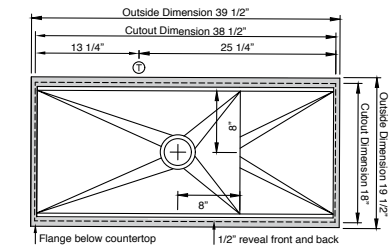

Center Galley Tap holes 2" from the back of the 18" countertop cutout

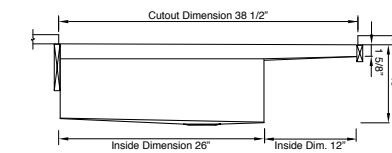

Important Installation Note: DryDock requires 2" minimum clearance below countertop

Customize Your Galley

Add 7-12" length	\$1,200	p. 80	9" depth	\$300	p. 80
Add 1-6" length	\$900	p. 80	Center drain	\$300	p. 80
Add 18" DryDock	\$1,800	p. 79	ThinTop™	\$500	p. 79
Add 12" DryDock	\$1,500	p. 79	WorkTop™	Custom	p. 79
Apron front	\$2,000	p. 79	*Color coded labels available		p. 87

DryDock Tool included (DR-12)



(1) Lower Tier Drying Rack
12 1/4" x 17"
DR-12-L-xx

For Galley Tap Suite see pages 93-112
For Freight see page 117

Recommended Basin Accessories & citrine.

Bottom Grate set BG-30-S-1-SS Stainless Steel

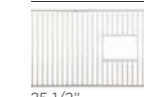

MSRP UMRP
\$325 \$293

Strainer M-DRN-MSS
Angel Finish 304 Stainless Steel



MSRP \$110
UMRP \$99

Disposal Strainer G-DRN-MSS
Angel Finish 304 Stainless Steel



MSRP \$110
UMRP \$99

Auto Strainer Angel Finish 304 Stainless Steel with Polished or Matte knob



A-DRN-PSS MSRP \$240 UMRP \$216
A-DRN-MSS MSRP \$220 UMRP \$198

CIT-09-SS-C
Stainless Steel
Clean + Polish 9 oz



MSRP UMRP
\$33 \$30

CIT-09-WD-C
Wood Condition + Protect 9 oz



MSRP UMRP
\$25 \$23

CIT-04-WD-B
Wood Finishing Balm 4 oz



MSRP UMRP
\$22 \$20



Ideal ThinTop™ Workstation 5S with American Black Walnut Culinary Kit, PVD Brushed Gold Stainless Steel Taps, Hot & Cold Tap, Soap Dispenser, and Deck Switch

Make any Workstation a ThinTop™
 For the most demanding designs



Through *thick* and *thin*

The ThinTop™ Galley Workstation is ideal for ultracompact kitchen countertop surfaces (porcelain or ceramic). By integrating the Upper Tier below the Basin flange, this Workstation eliminates the need for a thick countertop, resulting in a low-profile look that is both functional and beautiful.

Limitless design possibilities



ThinTop™

Make any Workstation a ThinTop.

TT-SS



MSRP \$500
UMRP \$450

Specifications

Outside dimensions: IWS O.D. x 19 1/2" x 11 1/16"
Interior dimensions: IWS I.D. x 18" x 10 3/4"
Countertop cutout: IWS I.D. x 18"
Basin area: IWS I.D. x 16"
Upper Tier 3/4" beneath countertop
Lower Tier 2 3/8" beneath countertop
Recommended for countertops 2cm thick or less
Compatible with all Tool materials/thicknesses

Basin (TT-SS)

16GA 316L stainless steel indoor/outdoor
SilentArmor™ sound reduction technology
Angel finish
Three tier design
Star™ groove pattern
Limited Lifetime Warranty
Made in the USA
ASME A112.19.3/CSA B45.4 certified
cUPC™ certified

EXAMPLE 1

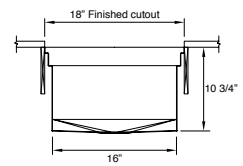

Suggested maximum inside corner radius of countertop cutout 3/8"

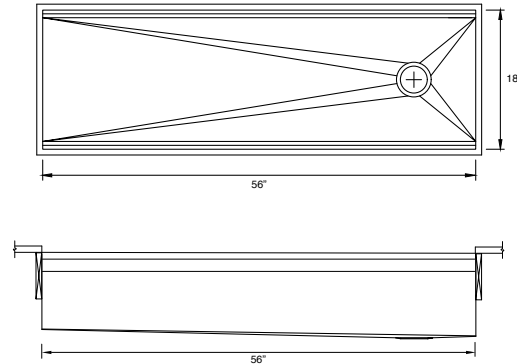

IWS-5-S-TT-xx

EXAMPLE 2

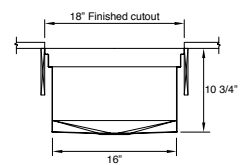

Suggested maximum inside corner radius of countertop cutout 3/8"

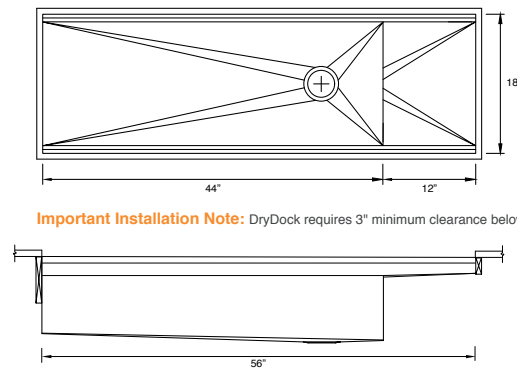

Important Installation Note: DryDock requires 3" minimum clearance below countertop

IWS-4-S-DD-12-S-TT-xx

EXAMPLE 3

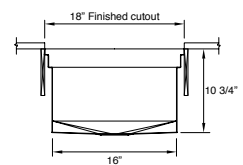

Suggested maximum inside corner radius of countertop cutout 3/8"

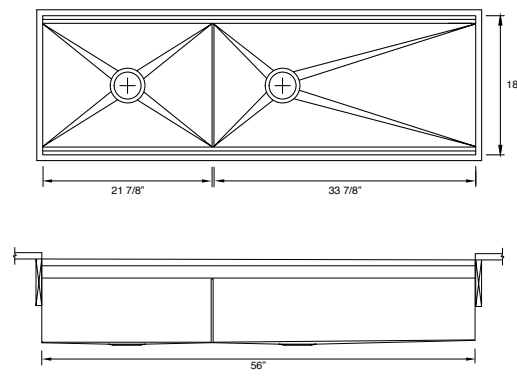

IWW-5-D-TT-xx

Ideal ThinTop™ Workstation. 5S

IWS-5-S-TT-WA



MSRP \$6,995
UMRP \$6,296

American Black Walnut

IWS-5-S-TT-GT



MSRP \$6,495
UMRP \$5,846

Graphite Wood Composite

IWS-5-S-TT-BA



MSRP \$6,495
UMRP \$5,846

Natural Golden Bamboo

IWS-5-S-TT-GR



MSRP \$6,095
UMRP \$5,486

Exclusive Gray Resin*

IWS-5-S-TT-WH



MSRP \$6,095
UMRP \$5,486

Designer White Resin*

Specifications

Single bowl
Users: 1-2
Culinary Tools included: Eight
Galley Taps recommended: Two
Outside dimensions: 57 1/2" x 19 1/2" x 11 1/16"
Interior dimensions: 56" x 18" x 10 3/4"
Countertop cutout: 56" x 18"
Basin area: 56" x 16"
Minimum cabinet size: 60" or 150cm

Basin (KSO-5-S-TT-SS)

16GA 316L stainless steel indoor/outdoor
SilentArmor™ sound reduction technology
Angel finish
Three tier design
Star™ groove pattern
Reversible side drain
Drain cover included
Limited Lifetime Warranty
Made in the USA
ASME A112.19.3/CSA B45.4 certified
cUPC™ certified

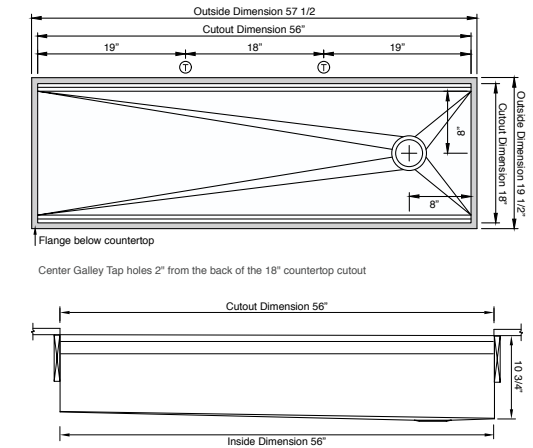

Center Galley Tap holes 2" from the back of the 18" countertop cutout

Customize Your Galley

Add 7-12" length	\$1,200	p. 80	9" depth	\$300	p. 80
Add 1-6" length	\$900	p. 80	Center drain	\$300	p. 80
Add 18" DryDock	\$1,800	p. 79	WorkTop™	Custom	p. 79
Add 12" DryDock	\$1,500	p. 79	*Color coded labels available		p. 87
Apron front	\$2,500	p. 79			

Culinary Tools included (CKT-17)

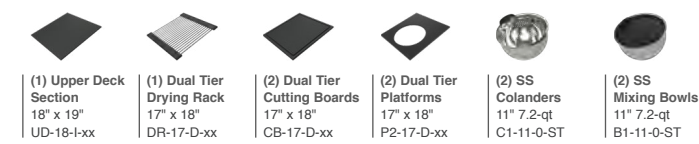

For Optional Culinary Tools see pages 85-90

Upper Deck.

Cover set UD-5-3P-WA/GT/BA/GR/WH Walnut, Graphite, Bamboo, Gray or White Resin

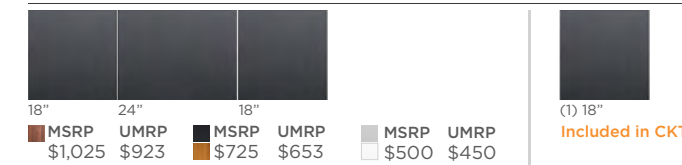

Sections Walnut, Graphite, Bamboo, Gray or White Resin

Section	MSRP	UMRP	Section	MSRP	UMRP
UD-24-I	\$325	\$293	UD-12-I	\$275	\$248
UD-18-I	\$225	\$203	UD-09-I	\$175	\$158
UD-12-I	\$225	\$203	UD-09-I	\$175	\$158
UD-09-I	\$150	\$135	UD-09-I	\$175	\$158

Online Specification Page
Order Form

Recommended Basin Accessories & citrine.

Bottom Grate set BG-5-S-2-SS Stainless Steel MSRP \$650 UMRP \$585	CIT-09-SS-C Stainless Steel Clean + Polish 9 oz MSRP \$33 UMRP \$30
Strainer M-DRN-MSS Angel Finish 304 Stainless Steel MSRP \$110 UMRP \$99	CIT-09-WD-C Wood Condition + Protect 9 oz MSRP \$25 UMRP \$23
Disposal Strainer G-DRN-MSS Angel Finish 304 Stainless Steel MSRP \$110 UMRP \$99	CIT-04-WD-B Wood Finishing Balm 4 oz MSRP \$22 UMRP \$20
Auto Strainer Angel Finish 304 Stainless Steel with Polished or Matte knob MSRP \$240 UMRP \$216	

Ideal ThinTop™ Workstation 4S

IWS-4-S-TT-WA



American Black Walnut

MSRP \$5,795
UMRP \$5,216

IWS-4-S-TT-GT



Graphite Wood Composite

MSRP \$5,395
UMRP \$4,856

IWS-4-S-TT-BA



Natural Golden Bamboo

MSRP \$5,395
UMRP \$4,856

IWS-4-S-TT-GR



Exclusive Gray Resin*

MSRP \$5,095
UMRP \$4,586

IWS-4-S-TT-WH



Designer White Resin*

MSRP \$5,095
UMRP \$4,586

Culinary Tools included (CKT-12)

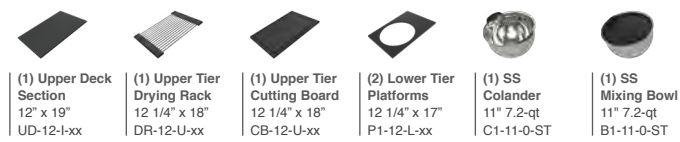

- (1) Upper Deck Section 12" x 19" UD-12-l-xx
- (1) Upper Tier Drying Rack 12 1/4" x 18" DR-12-U-xx
- (1) Upper Tier Cutting Board 12 1/4" x 18" CB-12-U-xx
- (2) Lower Tier Platforms 12 1/4" x 17" P1-12-L-xx
- (1) SS Colander 11" 7.2-qt C1-11-0-ST
- (1) SS Mixing Bowl 11" 7.2-qt B1-11-0-ST

For Optional Culinary Tools see pages 85-90

Upper Deck.

Cover set UD-4-2P-WA/GT/BA/GR/WH Walnut, Graphite, Bamboo, Gray or White Resin

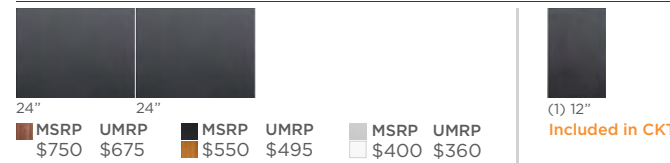

MSRP UMRP MSRP UMRP MSRP UMRP MSRP UMRP
\$750 \$675 \$550 \$495 \$400 \$360

Sections Walnut, Graphite, Bamboo, Gray or White Resin

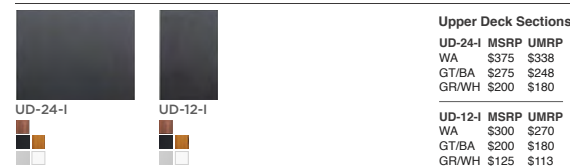

Upper Deck Sections
UD-24-1 MSRP UMRP \$300 \$270
WA \$375 \$338
GT/BA \$275 \$248
GR/WH \$200 \$180
UD-12-1 MSRP UMRP \$300 \$270
WA \$300 \$270
GT/BA \$200 \$180
GR/WH \$125 \$113

Specifications

Single bowl
Users: 1
Culinary Tools included: Five
Galley Tap recommended: One
Outside dimensions: 45 1/2" x 19 1/2" x 11 1/16"
Interior dimensions: 44" x 18" x 10 3/4"
Countertop cutout: 44" x 18"
Basin area: 44" x 16"
Minimum cabinet size: 48" or 120cm

Basin (KSO-4-S-TT-SS)

16GA 316L stainless steel indoor/outdoor
SilentArmor™ sound reduction technology
Angel finish
Three tier design
Star™ groove pattern
Reversible side drain
Drain cover included
Limited Lifetime Warranty
Made in the USA
ASME A112.19.3/CSA B45.4 certified
CUPC™ certified

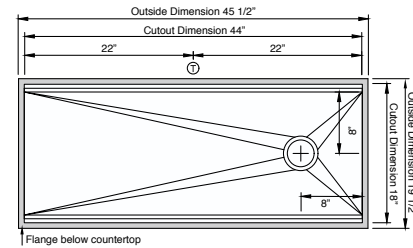

Center Galley Tap holes 2" from the back of the 18" countertop cutout

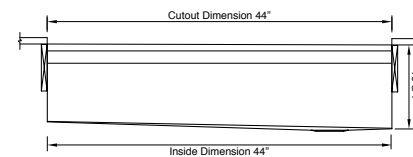

Customize Your Galley

Add 7-12" length	\$1,200	p. 80	9" depth	\$300	p. 80
Add 1-6" length	\$900	p. 80	Center drain	\$300	p. 80
Add 18" DryDock	\$1,800	p. 79	WorkTop™	Custom	p. 79
Add 12" DryDock	\$1,500	p. 79	*Color coded labels available		p. 87
Apron front	\$2,300	p. 79			

For Galley Tap Suite see pages 93-112
For Freight see page 117

Recommended Basin Accessories & citrine.

Bottom Grate set BG-4-S-2-SS Stainless Steel



MSRP UMRP
\$600 \$540

Strainer M-DRN-MSS Angel Finish 304 Stainless Steel



MSRP \$110
UMRP \$99

Disposal Strainer G-DRN-MSS Angel Finish 304 Stainless Steel



MSRP \$110
UMRP \$99

Auto Strainer Angel Finish 304 Stainless Steel with Polished or Matte knob



A-DRN-MSS shown

A-DRN-PSS MSRP \$240 UMRP \$216
A-DRN-MSS MSRP \$220 UMRP \$198

CIT-09-SS-C



Stainless Steel Clean + Polish 9 oz
MSRP UMRP
\$33 \$30

CIT-09-WD-C



Wood Condition + Protect 9 oz
MSRP UMRP
\$25 \$23

CIT-04-WD-B

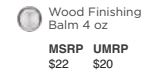

Wood Finishing Balm 4 oz
MSRP UMRP
\$22 \$20

Ideal ThinTop™ WashStation™ 4S

IWA-4-S-TT-WA



American Black Walnut / Graphite Resin+

MSRP \$5,195
UMRP \$4,676

IWA-4-S-TT-GT



Graphite Wood Composite / Graphite Resin+

MSRP \$5,095
UMRP \$4,586

IWA-4-S-TT-BA



Natural Golden Bamboo / Exclusive Gray Resin+

MSRP \$5,095
UMRP \$4,586

IWA-4-S-TT-GR



Exclusive Gray Resin+ / Resin+

MSRP \$4,995
UMRP \$4,496

IWA-4-S-TT-WH



Designer White Resin+ / Resin+

MSRP \$4,995
UMRP \$4,496

Wash Tools included (WKT-4T)



- (1) Upper Tier Drying Rack 9 1/4" x 18" DR-09-U-xx
- (1) Lower Tier Wash Caddy 6" x 17" WC-06-L-xx
- (1) Lower Tier Wash Bowl 12" x 17" WB-12-L-xx
- (1) Upper Tier Utensil Caddy 6" x 18" UC-06-U-xx

For Optional Culinary Tools see pages 85-90

Upper Deck.

Cover set UD-4-2P-WA/GT/BA/GR/WH Walnut, Graphite, Bamboo, Gray or White Resin

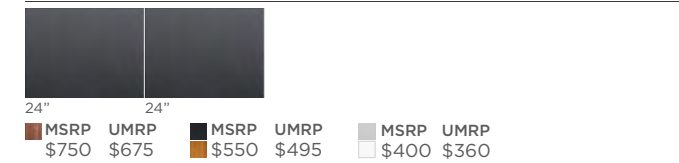

MSRP UMRP MSRP UMRP MSRP UMRP MSRP UMRP
\$750 \$675 \$550 \$495 \$400 \$360

Sections Walnut, Graphite, Bamboo, Gray or White Resin

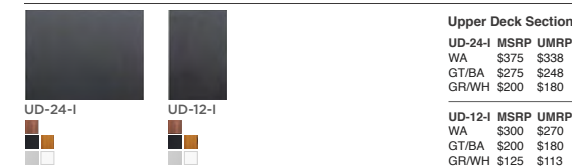

Upper Deck Sections
UD-24-1 MSRP UMRP \$300 \$270
WA \$375 \$338
GT/BA \$275 \$248
GR/WH \$200 \$180
UD-12-1 MSRP UMRP \$300 \$270
WA \$300 \$270
GT/BA \$200 \$180
GR/WH \$125 \$113

Specifications

Single bowl
Users: 1
Wash Tools included: Four
Galley Tap recommended: One
Outside dimensions: 45 1/2" x 19 1/2" x 11 1/16"
Interior dimensions: 44" x 18" x 10 3/4"
Countertop cutout: 44" x 18"
Basin area: 44" x 16"
Minimum cabinet size: 48" or 120cm

Basin (KSO-4-S-TT-SS)

16GA 316L stainless steel indoor/outdoor
SilentArmor™ sound reduction technology
Angel finish
Three tier design
Star™ groove pattern
Reversible side drain
Drain cover included
Limited Lifetime Warranty
Made in the USA
ASME A112.19.3/CSA B45.4 certified
CUPC™ certified

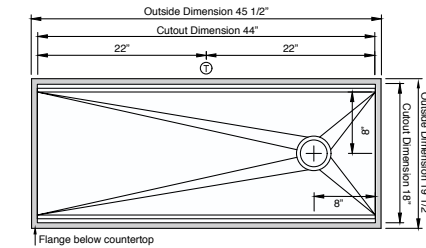

Center Galley Tap holes 2" from the back of the 18" countertop cutout

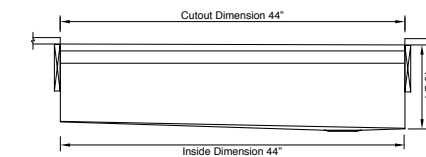

Customize Your Galley

Add 7-12" length	\$1,200	p. 80	9" depth	\$300	p. 80
Add 1-6" length	\$900	p. 80	Center drain	\$300	p. 80
Add 18" DryDock	\$1,800	p. 79	WorkTop™	Custom	p. 79
Add 12" DryDock	\$1,500	p. 79	*Color coded labels available		p. 87
Apron front	\$2,300	p. 79			

For Galley Tap Suite see pages 93-112
For Freight see page 117

Recommended Basin Accessories & citrine.

Bottom Grate set BG-4-S-2-SS Stainless Steel

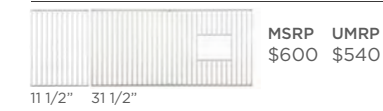

MSRP UMRP
\$600 \$540

Strainer M-DRN-MSS Angel Finish 304 Stainless Steel



MSRP \$110
UMRP \$99

Disposal Strainer G-DRN-MSS Angel Finish 304 Stainless Steel



MSRP \$110
UMRP \$99

Auto Strainer Angel Finish 304 Stainless Steel with Polished or Matte knob

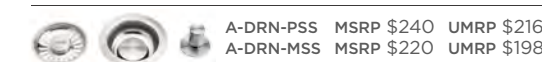

A-DRN-MSS shown

A-DRN-PSS MSRP \$240 UMRP \$216
A-DRN-MSS MSRP \$220 UMRP \$198

CIT-09-SS-C

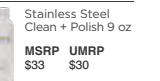

Stainless Steel Clean + Polish 9 oz
MSRP UMRP
\$33 \$30

CIT-09-WD-C



Wood Condition + Protect 9 oz
MSRP UMRP
\$25 \$23

CIT-04-WD-B



Wood Finishing Balm 4 oz
MSRP UMRP
\$22 \$20

Ideal ThinTop™ Workstation 3S

IWS-3-S-TT-WA



MSRP \$4,795
UMRP \$4,316

American Black Walnut

IWS-3-S-TT-GT



MSRP \$4,395
UMRP \$3,956

Graphite Wood Composite

IWS-3-S-TT-BA



MSRP \$4,395
UMRP \$3,956

Natural Golden Bamboo

IWS-3-S-TT-GR



MSRP \$4,095
UMRP \$3,686

Exclusive Gray Resin*

IWS-3-S-TT-WH



MSRP \$4,095
UMRP \$3,686

Designer White Resin*

Culinary Tools included (CKT-12)

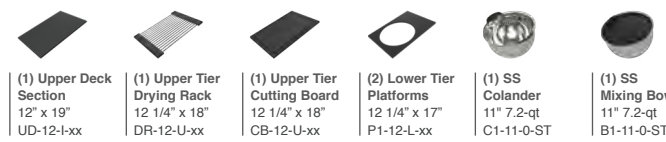

- | | | | | | |
|---|---|---|---|---|--|
| (1) Upper Deck Section
12" x 19"
UD-12-U-xx | (1) Upper Tier Drying Rack
12 1/4" x 18"
DR-12-U-xx | (1) Upper Tier Cutting Board
12 1/4" x 18"
CB-12-U-xx | (2) Lower Tier Platforms
12 1/4" x 17"
P1-12-L-xx | (1) SS Colander
11" 7.2-qt
C1-11-0-ST | (1) SS Mixing Bowl
11" 7.2-qt
B1-11-0-ST |
|---|---|---|---|---|--|

For Optional Culinary Tools see pages 85-90

Upper Deck.

Cover set UD-3-2P-WA/GT/BA/GR/WH Walnut, Graphite, Bamboo, Gray or White Resin

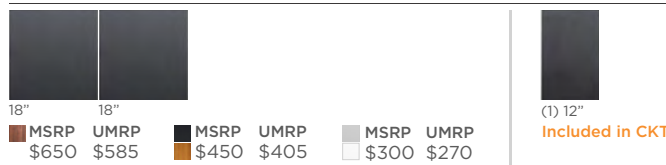

18" MSRP UMRP \$650 \$585	18" MSRP UMRP \$450 \$405	12" MSRP UMRP \$300 \$270
---------------------------	---------------------------	---------------------------

(1) 12" Included in CKT

Sections Walnut, Graphite, Bamboo, Gray or White Resin



Upper Deck Sections		Upper Deck Sections	
UD-18-I MSRP UMRP \$325 \$293	UD-09-I MSRP UMRP \$275 \$248	UD-12-I MSRP UMRP \$300 \$270	UD-06-I MSRP UMRP \$275 \$248
GT/BA \$225 \$203	GT/BA \$175 \$158	GT/BA \$200 \$180	GT/BA \$175 \$158
GR/WH \$150 \$135	GR/WH \$100 \$90	GR/WH \$125 \$113	GR/WH \$100 \$90

Ideal ThinTop™ WashStation™ 3S

IWA-3-S-TT-WA



MSRP \$4,195
UMRP \$3,776

American Black Walnut / Graphite Resin+

IWA-3-S-TT-GT



MSRP \$4,095
UMRP \$3,686

Graphite Wood Composite / Graphite Resin+

IWA-3-S-TT-BA



MSRP \$4,095
UMRP \$3,686

Natural Golden Bamboo / Exclusive Gray Resin+

IWA-3-S-TT-GR



MSRP \$3,995
UMRP \$3,596

Exclusive Gray Resin+ / Resin+

IWA-3-S-TT-WH

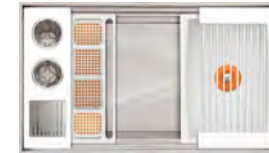

MSRP \$3,995
UMRP \$3,596

Designer White Resin+ / Resin+

Wash Tools included (WKT-4T)



- | | | | |
|--|---|---|--|
| (1) Upper Tier Drying Rack
9 1/4" x 18"
DR-09-U-xx | (1) Lower Tier Wash Caddy
6" x 17"
WC-06-L-xx | (1) Lower Tier Wash Bowl
12" x 17"
WB-12-L-xx | (1) Upper Tier Utensil Caddy
6" x 18"
UC-06-U-xx |
|--|---|---|--|

For Optional Culinary Tools see pages 85-90

Upper Deck.

Cover set UD-3-2P-WA/GT/BA/GR/WH Walnut, Graphite, Bamboo, Gray or White Resin

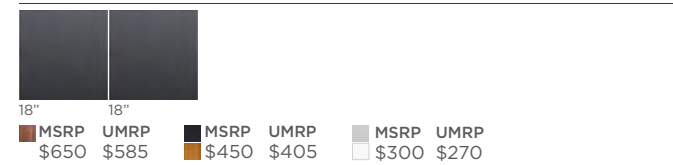

18" MSRP UMRP \$650 \$585	18" MSRP UMRP \$450 \$405	12" MSRP UMRP \$300 \$270
---------------------------	---------------------------	---------------------------

Sections Walnut, Graphite, Bamboo, Gray or White Resin

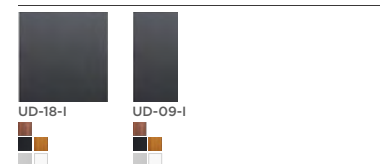

Upper Deck Sections		Upper Deck Sections	
UD-18-I MSRP UMRP \$325 \$293	UD-09-I MSRP UMRP \$275 \$248	UD-12-I MSRP UMRP \$300 \$270	UD-06-I MSRP UMRP \$275 \$248
GT/BA \$225 \$203	GT/BA \$175 \$158	GT/BA \$200 \$180	GT/BA \$175 \$158
GR/WH \$150 \$135	GR/WH \$100 \$90	GR/WH \$125 \$113	GR/WH \$100 \$90

Specifications

Single bowl
Users: 1
Culinary Tools included: Five
Galley Tap recommended: One
Outside dimensions: 33 1/2" x 19 1/2" x 11 1/16"
Interior dimensions: 32" x 18" x 10 3/4"
Countertop cutout: 32" x 18"
Basin area: 32" x 16"
Minimum cabinet size: 36" or 90cm

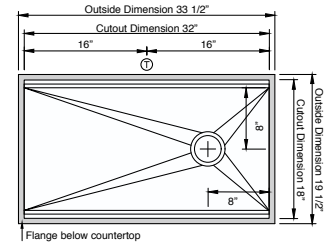

Center Galley Tap holes 2" from the back of the 18" countertop cutout

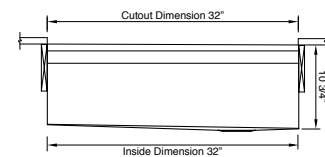

Basin (KSO-3-S-TT-SS)

16GA 316L stainless steel indoor/outdoor
SilentArmor™ sound reduction technology
Angel finish
Three tier design
Star™ groove pattern
Reversible side drain
Drain cover included
Limited Lifetime Warranty
Made in the USA
ASME A112.19.3/CSA B45.4 certified
cUPC™ certified

Customize Your Galley

Add 7-12" length \$1,200 p. 80	Add 1-6" length \$900 p. 80	Add 18" DryDock \$1,800 p. 79	Add 12" DryDock \$1,500 p. 79	Apron front \$2,100 p. 79	9" depth \$300 p. 80	Center drain \$300 p. 80	WorkTop™ Custom p. 79	*Color coded labels available p. 87
--------------------------------	-----------------------------	-------------------------------	-------------------------------	---------------------------	----------------------	--------------------------	-----------------------	-------------------------------------

For Galley Tap Suite see pages 93-112
For Freight see page 117

Recommended Basin Accessories & citrine.

Bottom Grate set BG-3-S-1-SS Stainless Steel

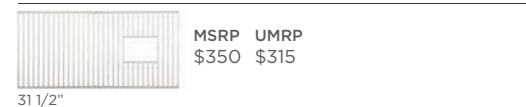

MSRP UMRP \$350 \$315

Strainer M-DRN-MSS Angel Finish 304 Stainless Steel



MSRP \$110 UMRP \$99

Disposal Strainer G-DRN-MSS Angel Finish 304 Stainless Steel



MSRP \$110 UMRP \$99

Auto Strainer Angel Finish 304 Stainless Steel with Polished or Matte knob



A-DRN-PSS MSRP \$240 UMRP \$216
A-DRN-MSS MSRP \$220 UMRP \$198

CIT-09-SS-C Stainless Steel Clean + Polish 9 oz



MSRP UMRP \$33 \$30

CIT-09-WD-C Wood Condition + Protect 9 oz



MSRP UMRP \$25 \$23

CIT-04-WD-B Wood Finishing Balm 4 oz

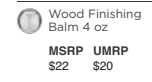

MSRP UMRP \$22 \$20

Specifications

Single bowl
Users: 1
Wash Tools included: Four
Galley Tap recommended: One
Outside dimensions: 33 1/2" x 19 1/2" x 11 1/16"
Interior dimensions: 32" x 18" x 10 3/4"
Countertop cutout: 32" x 18"
Basin area: 32" x 16"
Minimum cabinet size: 36" or 90cm

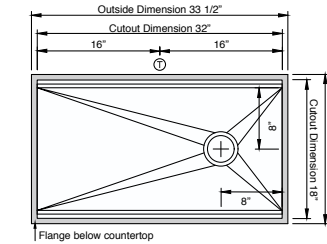

Center Galley Tap holes 2" from the back of the 18" countertop cutout

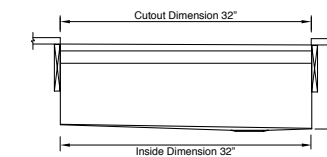

Basin (KSO-3-S-TT-SS)

16GA 316L stainless steel indoor/outdoor
SilentArmor™ sound reduction technology
Angel finish
Three tier design
Star™ groove pattern
Reversible side drain
Drain cover included
Limited Lifetime Warranty
Made in the USA
ASME A112.19.3/CSA B45.4 certified
cUPC™ certified

Customize Your Galley

Add 7-12" length \$1,200 p. 80	Add 1-6" length \$900 p. 80	Add 18" DryDock \$1,800 p. 79	Add 12" DryDock \$1,500 p. 79	Apron front \$2,100 p. 79	9" depth \$300 p. 80	Center drain \$300 p. 80	WorkTop™ Custom p. 79	*Color coded labels available p. 87
--------------------------------	-----------------------------	-------------------------------	-------------------------------	---------------------------	----------------------	--------------------------	-----------------------	-------------------------------------

For Galley Tap Suite see pages 93-112
For Freight see page 117

Recommended Basin Accessories & citrine.

Bottom Grate set BG-3-S-1-SS Stainless Steel

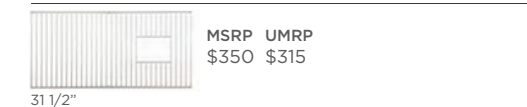

MSRP UMRP \$350 \$315

Strainer M-DRN-MSS Angel Finish 304 Stainless Steel



MSRP \$110 UMRP \$99

Disposal Strainer G-DRN-MSS Angel Finish 304 Stainless Steel



MSRP \$110 UMRP \$99

Auto Strainer Angel Finish 304 Stainless Steel with Polished or Matte knob



A-DRN-PSS MSRP \$240 UMRP \$216
A-DRN-MSS MSRP \$220 UMRP \$198

CIT-09-SS-C Stainless Steel Clean + Polish 9 oz



MSRP UMRP \$33 \$30

CIT-09-WD-C Wood Condition + Protect 9 oz

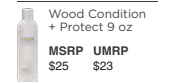

MSRP UMRP \$25 \$23

CIT-04-WD-B Wood Finishing Balm 4 oz

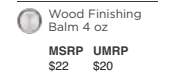

MSRP UMRP \$22 \$20

Ideal ThinTop™ Workstation 3S + DryDock 12

IWS-3-S-DD-12-S-TT-WA



MSRP \$6,620
UMRP \$5,958

American Black Walnut

IWS-3-S-DD-12-S-TT-GT



MSRP \$5,870
UMRP \$5,283

Graphite Wood Composite

IWS-3-S-DD-12-S-TT-BA



MSRP \$5,870
UMRP \$5,283

Natural Golden Bamboo

IWS-3-S-DD-12-S-TT-GR



MSRP \$5,720
UMRP \$5,148

Exclusive Gray Resin*

IWS-3-S-DD-12-S-TT-WH



MSRP \$5,720
UMRP \$5,148

Designer White Resin*

Culinary Tools included (CKT-12)

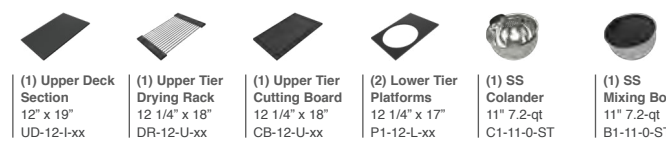

(1) Upper Deck Section 12" x 19" UD-12-l-xx	(1) Upper Tier Drying Rack 12 1/4" x 18" DR-12-U-xx	(1) Upper Tier Cutting Board 12 1/4" x 18" CB-12-U-xx	(2) Lower Tier Platforms 12 1/4" x 17" P1-12-L-xx	(1) SS Colander 11" 7.2-qt C1-11-0-ST	(1) SS Mixing Bowl 11" 7.2-qt B1-11-0-ST
---	---	---	---	---	--

For Optional Culinary Tools see pages 85-90

Upper Deck.

Cover set UD-3-12-3P-WA/GT/BA/GR/WH Walnut, Graphite, Bamboo, Gray or White Resin

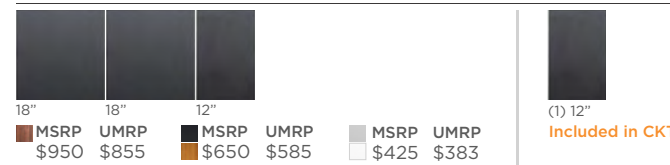

18" MSRP UMRP \$950 \$855	12" MSRP UMRP \$650 \$585	12" MSRP UMRP \$425 \$383
---------------------------	---------------------------	---------------------------

(1) 12" Included in CKT

Sections Walnut, Graphite, Bamboo, Gray or White Resin



Upper Deck Sections		UD-09-I MSRP UMRP	
UD-18-I	MSRP UMRP \$325 \$293	WA	\$275 \$248
GT/BA	\$225 \$203	GT/BA	\$175 \$158
GR/WH	\$150 \$135	GR/WH	\$100 \$90

UD-12-I MSRP UMRP		UD-06-I MSRP UMRP	
WA	\$300 \$270	WA	\$275 \$248
GT/BA	\$200 \$180	GT/BA	\$175 \$158
GR/WH	\$125 \$113	GR/WH	\$100 \$90

Specifications

Single bowl
Users: 1
Culinary Tools included: Five
DryDock Tool included: One
Galley Tap recommended: One
Outside dimensions: 45 1/2" x 19 1/2" x 2 7/8"
Interior dimensions: 44" x 18" x 2 3/4"
Countertop cutout: 44" x 18"
Minimum cabinet size: 48" or 120cm
Minimum clearance required for DryDock below countertop: 3"
DryDock location: Drain side (S)

Basin (KSO-3-S-DS-12-S-TT-SS)

16GA 316L stainless steel indoor/outdoor
SilentArmor™ sound reduction technology
Angel finish
Three tier design
Star™ groove pattern
Reversible side drain
Drain cover included
Limited Lifetime Warranty
Made in the USA
ASME A112.19.3/CSA B45.4 certified
cUPC™ certified

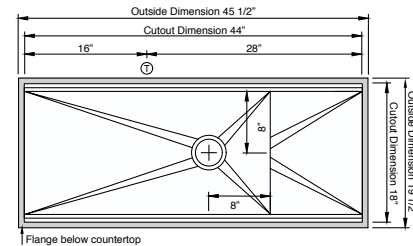

Flange below countertop

Center Galley Tap holes 2" from the back of the 18" countertop cutout

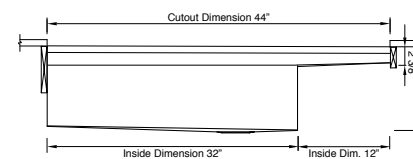

Important Installation Note: DryDock requires 3" minimum clearance below countertop

Customize Your Galley

Add 7-12" length	\$1,200	p. 80	9" depth	\$300	p. 80
Add 1-6" length	\$900	p. 80	Center drain	\$300	p. 80
Add 18" DryDock	\$1,800	p. 79	WorkTop™	Custom	p. 79
Add 12" DryDock	\$1,500	p. 79	*Color coded labels available		p. 87
Apron front	\$2,100	p. 79			

DryDock Tool included (DR-12)



(1) Lower Tier Drying Rack
12 1/4" x 17"
DR-12-L-xx

For Galley Tap Suite see pages 93-112
For Freight see page 117

Recommended Basin Accessories & citrine.

Bottom Grate set BG-3-S-1-SS Stainless Steel

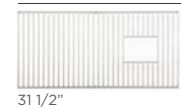

MSRP UMRP \$350 \$315

Strainer M-DRN-MSS Angel Finish 304 Stainless Steel



Disposal Strainer G-DRN-MSS Angel Finish 304 Stainless Steel



Auto Strainer Angel Finish 304 Stainless Steel with Polished or Matte knob



A-DRN-PSS MSRP \$240 UMRP \$216
A-DRN-MSS MSRP \$220 UMRP \$198

CIT-09-SS-C



Stainless Steel Clean + Polish 9 oz
MSRP UMRP \$33 \$30

CIT-09-WD-C



Wood Condition + Protect 9 oz
MSRP UMRP \$25 \$23

CIT-04-WD-B

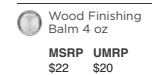

Wood Finishing Balm 4 oz
MSRP UMRP \$22 \$20

Ideal ThinTop™ WashStation 3S + DryDock 12

IWA-3-S-DD-12-S-TT-WA



MSRP \$6,020
UMRP \$5,418

American Black Walnut / Graphite Resin+

IWA-3-S-DD-12-S-TT-GT



MSRP \$5,870
UMRP \$5,283

Graphite Wood Composite / Graphite Resin+

IWA-3-S-DD-12-S-TT-BA

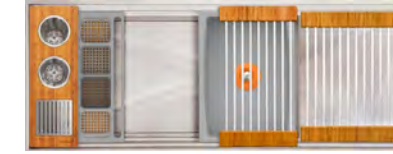

MSRP \$5,870
UMRP \$5,283

Natural Golden Bamboo / Exclusive Gray Resin+

IWA-3-S-DD-12-S-TT-GR



MSRP \$5,720
UMRP \$5,148

Exclusive Gray Resin* / Resin+

IWA-3-S-DD-12-S-TT-WH



MSRP \$5,720
UMRP \$5,148

Designer White Resin* / Resin+

Wash Tools included (WKT-4T)



(1) Upper Tier Drying Rack 9 1/4" x 18" DR-09-U-xx	(1) Lower Tier Wash Caddy 6" x 17" WC-06-L-xx	(1) Lower Tier Wash Bowl 12" x 17" WB-12-L-xx	(1) Upper Tier Utensil Caddy 6" x 18" UC-06-U-xx
--	---	---	--

For Optional Culinary Tools see pages 85-90

Upper Deck.

Cover set UD-3-12-3P-WA/GT/BA/GR/WH Walnut, Graphite, Bamboo, Gray or White Resin

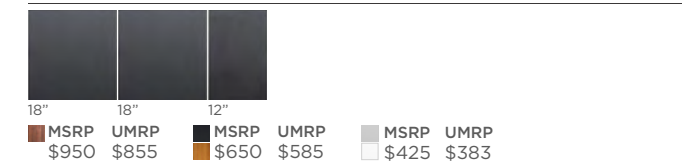

18" MSRP UMRP \$950 \$855	12" MSRP UMRP \$650 \$585	12" MSRP UMRP \$425 \$383
---------------------------	---------------------------	---------------------------

Sections Walnut, Graphite, Bamboo, Gray or White Resin



Upper Deck Sections		UD-09-I MSRP UMRP	
UD-18-I	MSRP UMRP \$325 \$293	WA	\$275 \$248
GT/BA	\$225 \$203	GT/BA	\$175 \$158
GR/WH	\$150 \$135	GR/WH	\$100 \$90

UD-12-I MSRP UMRP		UD-06-I MSRP UMRP	
WA	\$300 \$270	WA	\$275 \$248
GT/BA	\$200 \$180	GT/BA	\$175 \$158
GR/WH	\$125 \$113	GR/WH	\$100 \$90

Specifications

Single bowl
Users: 1
Wash Tools included: Four
DryDock Tool included: One
Galley Tap recommended: One
Outside dimensions: 45 1/2" x 19 1/2" x 2 7/8"
Interior dimensions: 44" x 18" x 2 3/4"
Countertop cutout: 44" x 18"
Minimum cabinet size: 48" or 120cm
Minimum clearance required for DryDock below countertop: 3"
DryDock location: Drain side (S)

Basin (KSO-3-S-DS-12-S-TT-SS)

16GA 316L stainless steel indoor/outdoor
SilentArmor™ sound reduction technology
Angel finish
Three tier design
Star™ groove pattern
Reversible side drain
Drain cover included
Limited Lifetime Warranty
Made in the USA
ASME A112.19.3/CSA B45.4 certified
cUPC™ certified

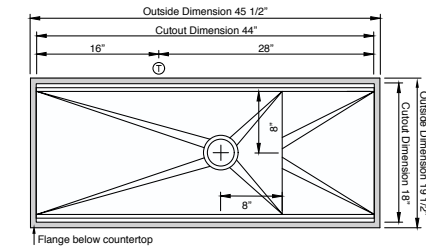

Flange below countertop

Center Galley Tap holes 2" from the back of the 18" countertop cutout

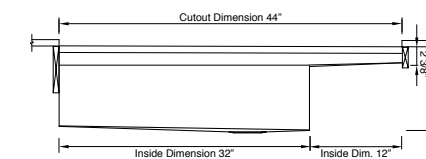

Important Installation Note: DryDock requires 3" minimum clearance below countertop

Customize Your Galley

Add 7-12" length	\$1,200	p. 80	9" depth	\$300	p. 80
Add 1-6" length	\$900	p. 80	Center drain	\$300	p. 80
Add 18" DryDock	\$1,800	p. 79	WorkTop™	Custom	p. 79
Add 12" DryDock	\$1,500	p. 79	*Color coded labels available		p. 87
Apron front	\$2,100	p. 79			

DryDock Tool included (DR-12)



(1) Lower Tier Drying Rack
12 1/4" x 17"
DR-12-L-xx

For Galley Tap Suite see pages 93-112
For Freight see page 117

Recommended Basin Accessories & citrine.

Bottom Grate set BG-3-S-1-SS Stainless Steel



MSRP UMRP \$350 \$315

Strainer M-DRN-MSS Angel Finish 304 Stainless Steel



Disposal Strainer G-DRN-MSS Angel Finish 304 Stainless Steel



Auto Strainer Angel Finish 304 Stainless Steel with Polished or Matte knob



A-DRN-PSS MSRP \$240 UMRP \$216
A-DRN-MSS MSRP \$220 UMRP \$198

CIT-09-SS-C



Stainless Steel Clean + Polish 9 oz
MSRP UMRP \$33 \$30

CIT-09-WD-C



Wood Condition + Protect 9 oz
MSRP UMRP \$25 \$23

CIT-04-WD-B

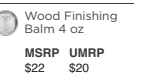

Wood Finishing Balm 4 oz
MSRP UMRP \$22 \$20



Ideal Workstation 3S with Exclusive Gray Resin Culinary Kit, Apron Front, Polished Stainless Steel Tap

Tailor Made

The Galley offers you the ability to create your very own Workstation or WashStation™. Apron Front, custom lengths, integrated Galleys with stainless steel WorkTops, ADA, you name it and we can probably do it. Our highly trained factory craftsmen love a good challenge!

Dare to be different

INTEGRATE

WorkTop™
DryDock.



MODERNIZE

ThinTop™
Apron Front

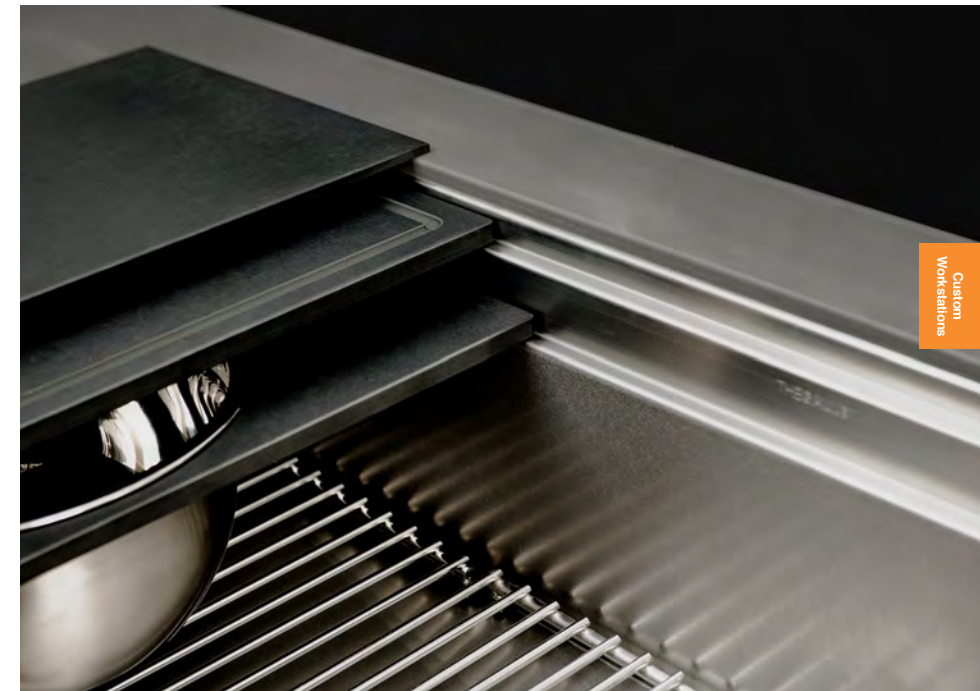

ACCESS

ADA Compliant
Length



Custom Built Workstation Basins

Lead time 5-6 weeks



WorkTop™

Integrate any Workstation into a stainless steel countertop of various thicknesses and shapes with or without a backsplash. It is beautiful, sleek, and highly resistant to scratches, stains, and heat.

To request a custom quote, contact us at dealersupport@thegalley.com.

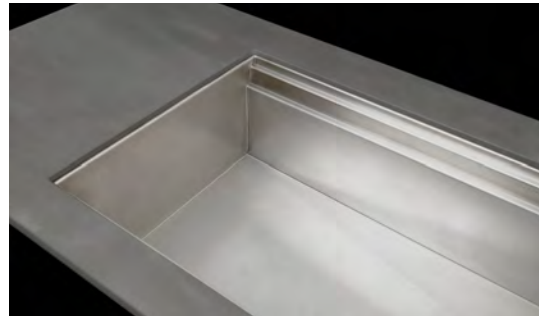

ThinTop™

Designed to accommodate thinner countertops and ultracompact surfaces, our ThinTop Workstations have the Upper Tier integrated into the Basin to allow our Culinary Tools to function perfectly, no matter the countertop thickness or material.

Description	Product Code	Add MSRP	Add UMRP
ThinTop™	TT	\$500	\$450



Add DryDock.

Expand the functionality of the Galley without sacrificing under-counter storage or appliances, by adding an 18 or 12-inch Built-in DryDock to either or both sides of any Workstation.

Description	Product Code	Add MSRP	Add UMRP
DryDock 18"	DS-18-X	\$1,800	\$1,620
DryDock 12"	DS-12-X	\$1,500	\$1,350

Location: Drain side (S) and/or non-drain side (N) and/or center drain (C)
Note: DryDock only (not including DryDock Tool)



Apron Front

Personalize your design with our customizable stainless steel Apron Front, allowing you to tailor its thickness and height to perfectly complement your countertop.

Description	Product Code	Add MSRP	Add UMRP
For IWS 7	AF	\$2,900	\$2,610
For IWS 6	AF	\$2,700	\$2,430
For IWS 5	AF	\$2,500	\$2,250
For IWS 4	AF	\$2,300	\$2,070
For IWS 3	AF	\$2,100	\$1,890
For IWS 30	AF	\$2,000	\$1,800
For IWS 2	AF	\$1,900	\$1,710
For IBS 18	AF	\$1,800	\$1,620

Note: Please specify Apron height, thickness and drain location

Custom order example: **IWS-4-S-AF-AL4-GT**
 (Ideal Workstation 4S, Apron Front, Add 4" Length, Graphite Culinary Kit)

Note: Once the purchase order and approved drawings are received each custom order is noncancelable

Custom Built Workstation Basins

Lead time 5-6 weeks



Top Mount / Flush Mount

Ideal for spaces where modifying existing countertops is not feasible and for those who enjoy an above-counter flange aesthetic.

Description	Product Code	Add MSRP	Add UMRP
Top/Flush Mount	TF	\$500	\$450

Note: Please specify back flange depth, desired Tap products, and hole placements



Custom Length or Center Drain

Customize the length and/or drain location of your Workstation to perfectly fit your kitchen.

Description	Product Code	Add MSRP	Add UMRP
Add 7-12"	AL#	\$1,200	\$1,080
Add 1-6"	AL#	\$900	\$810
Center Drain	C	\$300	\$270

Note: Added length 1-6" includes Culinary Kit IWS from next size below
 Added length 7-12" includes Culinary Kit IWS from next size above
 The maximum overall length recommended is 2 1/2" smaller than the outside cabinet dimension



Add Bowl

Add another bowl to the Basin to create a versatile double or triple bowl Workstation for any kitchen that demands maximum efficiency.

Description	Product Code	Add MSRP	Add UMRP
Add Bowl	AB	\$2,500	\$2,250

Note: Please specify width of each bowl/section

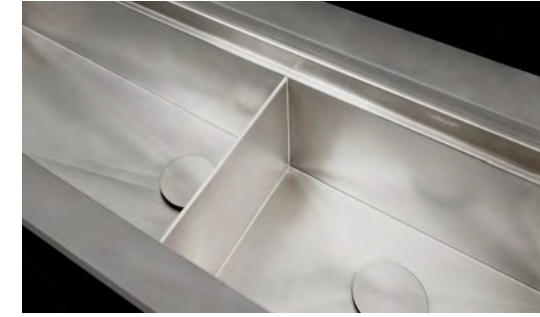

Move or Lower Double Bowl Divider

Customize the placement and height of your Work&WashStations™ permanent divider within the Basin to fit your specific needs.

Description	Product Code	Add MSRP	Add UMRP
Move Divider	MD	\$1,000	\$900
Lower Divider	LD	\$500	\$450

Note: Custom Bottom Grates may be required



ADA or 9" Bowl Depth

Designed to provide a more accessible and user-friendly experience, ADA Workstations have a Basin depth of 5 7/8" along with customized Tools.

Description	Product Code	Add MSRP	Add UMRP
ADA Compliant	ADA	\$300	\$270
9" Bowl Depth	BD9	\$300	\$270

ADA Kits: CKT-17-ADA*, CKT-12-ADA*

*Includes 4" high Mixing Bowls and Colanders



Ideal Workstation 4S with Graphite Wood Composite Culinary Kit, PVD Satin Black Stainless Steel BarTap, Soap Dispenser, and Deck Switch

Taking it to the next level

The Upper Deck® is a modular third tier workspace and cover system available in all four finishes. The sections slide apart for easy removal and each one can be used individually on the countertop tier. Use as a complete set to cover the Workstation or individually as work surfaces.

Elevate your Workstation

The Upper Deck

Let's take it outside

Experience the power of the Galley Workstation and Tap in your outdoor kitchen. Stay outdoors and enjoy spending quality time with your family and friends as you prepare, cook, serve, entertain, and clean right next to your grill. Made of marine grade 316L Stainless Steel, the Tap and Workstation with Graphite Wood Composite, Designer White or Exclusive Gray Resin Culinary Tools are ideal for both indoor and outdoor use.

Revolutionize outdoor living









Ideal Workstation 4S with Graphite Wood Composite Upper Deck Set, PVD Satin Black Stainless Steel BarTap, Soap Dispenser, and Deck Switch

The Upper Deck

Upper Deck.

Sections

UD-24-I-WA/GT/BA/GR/WH  24"	MSRP UMRP \$375 \$338 \$275 \$248 \$200 \$180	UD-12-I-WA/GT/BA/GR/WH  12"	MSRP UMRP \$300 \$270 \$200 \$180 \$125 \$113
UD-20-C-I-WA/GT/BA/GR/WH <i>Note: Corner Workstation Only</i>  20"	MSRP UMRP \$400 \$360 \$300 \$270 \$275 \$248	UD-09-I-WA/GT/BA/GR/WH  9"	MSRP UMRP \$275 \$248 \$175 \$158 \$100 \$90
UD-18-I-WA/GT/BA/GR/WH  18"	MSRP UMRP \$325 \$293 \$225 \$203 \$150 \$135	UD-06-I-WA/GT/BA/GR/WH  6"	MSRP UMRP \$275 \$248 \$175 \$158 \$100 \$90







Specifications

Available in sections or complete sets
 24", 20" (Corner only), 18", 12", 9", 6" sections 19" deep
 Cover system and third tier work surface
 Sits in 18" deep and 5/16" above countertop cutout
Requires 1/4" clearance below countertop surface

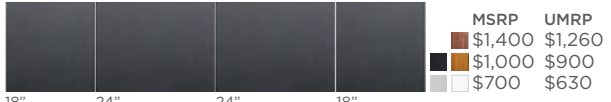
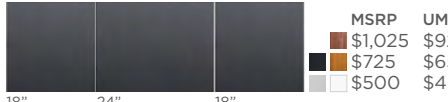
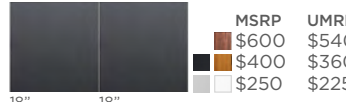
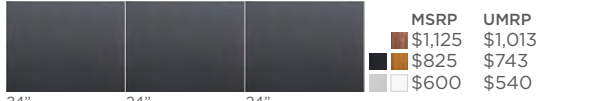
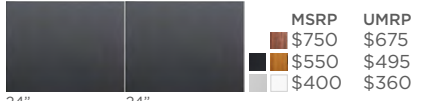
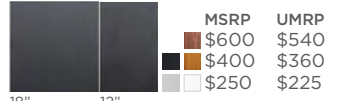
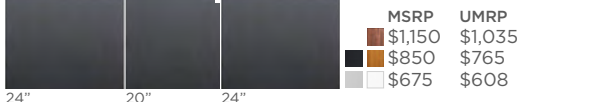
Upper Deck Materials

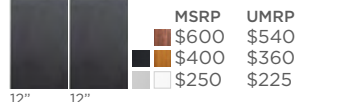

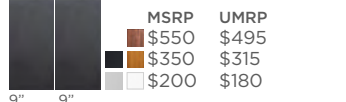
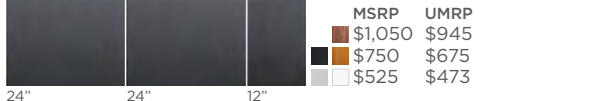
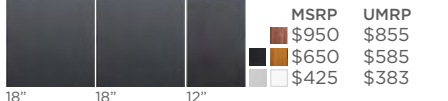

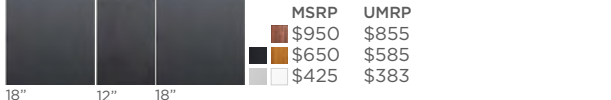
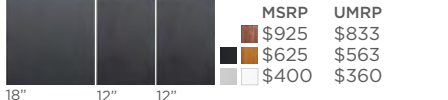

Prestige	Premium	Standard
American Black Walnut (WA)	Graphite Wood Composite (GT)	Natural Golden Bamboo (BA)
Exclusive Gray Resin (GR)	Designer White Resin (WH)	

Complete Sets

UD-7-4P-WA/GT/BA/GR/WH For IWS-7-S & IWW-7-D  18" 24" 24" 18"	MSRP UMRP \$1,400 \$1,260 \$1,000 \$900 \$700 \$630	UD-5-3P-WA/GT/BA/GR/WH For IWS-5-S & IWW-5-D  18" 24" 18"	MSRP UMRP \$1,025 \$923 \$725 \$653 \$500 \$450	UD-3-2P-WA/GT/BA/GR/WH For IWS/IWA-3-S  18" 18"	MSRP UMRP \$600 \$540 \$400 \$360 \$250 \$225
UD-6-3P-WA/GT/BA/GR/WH For IWS-6-S & IWW-6-D  24" 24" 24"	MSRP UMRP \$1,125 \$1,013 \$825 \$743 \$600 \$540	UD-4-2P-WA/GT/BA/GR/WH For IWS/IWA-4-S & IWA/IWW-4-D  24" 24"	MSRP UMRP \$750 \$675 \$550 \$495 \$400 \$360	UD-30-2P-WA/GT/BA/GR/WH For IWS/IWA-30-S  18" 12"	MSRP UMRP \$600 \$540 \$400 \$360 \$250 \$225
UD-4X4-3P-WA/GT/BA/GR/WH For IWS/IWA-4X4-C  24" 20" 24"	MSRP UMRP \$1,150 \$1,035 \$850 \$765 \$675 \$608	UD-4X3-3P-WA/GT/BA/GR/WH For IWS/IWA-3X4-C & 4X3-C  12" 20" 24"	MSRP UMRP \$1,075 \$968 \$775 \$698 \$600 \$540	UD-2-2P-WA/GT/BA/GR/WH For IWS/IWA/IBS-2-C  12" 12"	MSRP UMRP \$600 \$540 \$400 \$360 \$250 \$225
UD-4-18-3P-WA/GT/BA/GR/WH For IWS/IWA-4-S-DD-18-S  24" 24" 18"	MSRP UMRP \$1,075 \$968 \$775 \$698 \$550 \$495	UD-3-18-3P-WA/GT/BA/GR/WH For IWS/IWA-3-S-DD-18-S  18" 18" 18"	MSRP UMRP \$975 \$878 \$675 \$608 \$450 \$405	UD-18-2P-WA/GT/BA/GR/WH For IBS-18-C  9" 9"	MSRP UMRP \$550 \$495 \$350 \$315 \$200 \$180
UD-4-12-3P-WA/GT/BA/GR/WH For IWS/IWA-4-S-DD-12-S  24" 24" 12"	MSRP UMRP \$1,050 \$945 \$750 \$675 \$525 \$473	UD-3-12-3P-WA/GT/BA/GR/WH For IWS/IWA-3-S-DD-12-S  18" 18" 12"	MSRP UMRP \$950 \$855 \$650 \$585 \$425 \$383	UD-1-1P-WA/GT/BA/GR/WH For IHS-1-V  10"	MSRP UMRP \$250 \$225 \$150 \$135 \$75 \$68
UD-30-18-3P-WA/GT/BA/GR/WH For IWS/IWA-30-S-DD-18-S  18" 12" 18"	MSRP UMRP \$950 \$855 \$650 \$585 \$425 \$383	UD-30-12-3P-WA/GT/BA/GR/WH For IWS/IWA-30-S-DD-12-S  18" 12" 12"	MSRP UMRP \$925 \$833 \$625 \$563 \$400 \$360		

Basin Accessories

Bottom Grate Sections

BG-31-S-SS  31 1/2" MSRP \$350 UMRP \$315	BG-29-S-SS  29" MSRP \$350 UMRP \$315	BG-25-N-SS  25 1/2" MSRP \$325 UMRP \$293	BG-25-S-SS  25 1/2" MSRP \$325 UMRP \$293	BG-23-N-SS  23 1/2" MSRP \$300 UMRP \$270	BG-20-C-SS  20" MSRP \$300 UMRP \$270	BG-13-C-SS  13 1/2" MSRP \$250 UMRP \$225	BG-11-N-SS 11 1/2" MSRP \$250 UMRP \$225	BG-05-N-SS 5 1/2" MSRP \$200 UMRP \$180
---	---	---	---	---	---	---	---	--

Bottom Grate Sets



Workstations and WashStations™ in Stainless Steel

BG-7-S-3-SS For IWS-7-S  23 1/2" 23 1/2" 31 1/2" MSRP \$950 UMRP \$855
--

BG-6-S-3-SS For IWS-6-S  11 1/2" 23 1/2" 31 1/2" MSRP \$900 UMRP \$810
--

BG-5-S-2-SS For IWS-5-S  23 1/2" 31 1/2" MSRP \$650 UMRP \$585

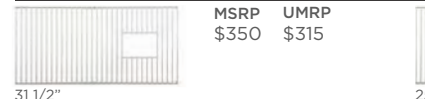
BG-4-S-2-SS For IWS-4-S & IWA-4-S  11 1/2" 31 1/2" MSRP \$600 UMRP \$540
--

BG-3-S-1-SS For IWS-3-S & IWA-3-S  31 1/2" MSRP \$350 UMRP \$315	BG-30-S-1-SS For IWS-30-S & IWA-30-S  25 1/2" MSRP \$325 UMRP \$293
--	---

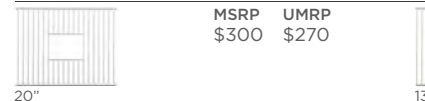
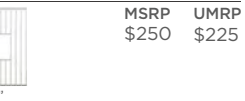
BG-2-C-1-SS For IWS-2-C, IWA-2-C & IBS-2-C  20" MSRP \$300 UMRP \$270	BG-18-C-1-SS For IBS-18-C  13 1/2" MSRP \$250 UMRP \$225
---	--

Bottom Grate Sets

Corner Workstations and WashStations in Stainless Steel

BG-4X4-C-3-SS For IWS-4X4-C & IWA-4X4-C  11 1/2" 25 1/2" 29" MSRP \$925 UMRP \$833
--

BG-4X3-C-2-SS For IWS-3X4-C, 4X3-C & IWA-3X4-C, 4X3-C  25 1/2" 29" MSRP \$675 UMRP \$608
--

Bottom Grate Sets

Work&WashStations™ in Stainless Steel

BG-7-D-3-SS For IWW-7-D  20" 31 1/2" 23 1/2" MSRP \$950 UMRP \$855
--

BG-6-D-3-SS For IWW-6-D  20" 31 1/2" 11 1/2" MSRP \$900 UMRP \$810
--

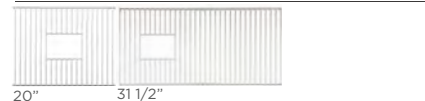
BG-5-D-2-SS For IWW-5-D  20" 31 1/2" MSRP \$650 UMRP \$585

BG-4-D-2-SS For IWW-4-D  20" 20" MSRP \$600 UMRP \$540
--

Specifications

Available partial or complete sets
 15 1/2" deep
 Indoor / outdoor
 1/4" thick solid electroplated stainless steel rod
 Protective feet included

Strainer Baskets

Manual Strainer Basket M-DRN-MSS Angel Finish  MSRP \$110 UMRP \$99	Disposal Flange Strainer Basket/Stopper G-DRN-MSS Angel Finish  MSRP \$110 UMRP \$99
Auto Strainer Basket A-DRN-PSS Angel Finish with Polished knob  MSRP \$240 UMRP \$216	Auto Strainer Basket A-DRN-MSS Angel Finish with Matte knob  MSRP \$220 UMRP \$198

Specifications

Fits standard 3 1/2" US drain openings
 Standard 1 1/2" male connection to drain plumbing (M-DRN, A-DRN)
 27 1/2" cable (A-DRN)
 Substantial knob design
 304 Stainless Steel finished parts

OPTIONAL CULINARY TOOLS

Our versatile Workstation Culinary Tools are only limited by your imagination

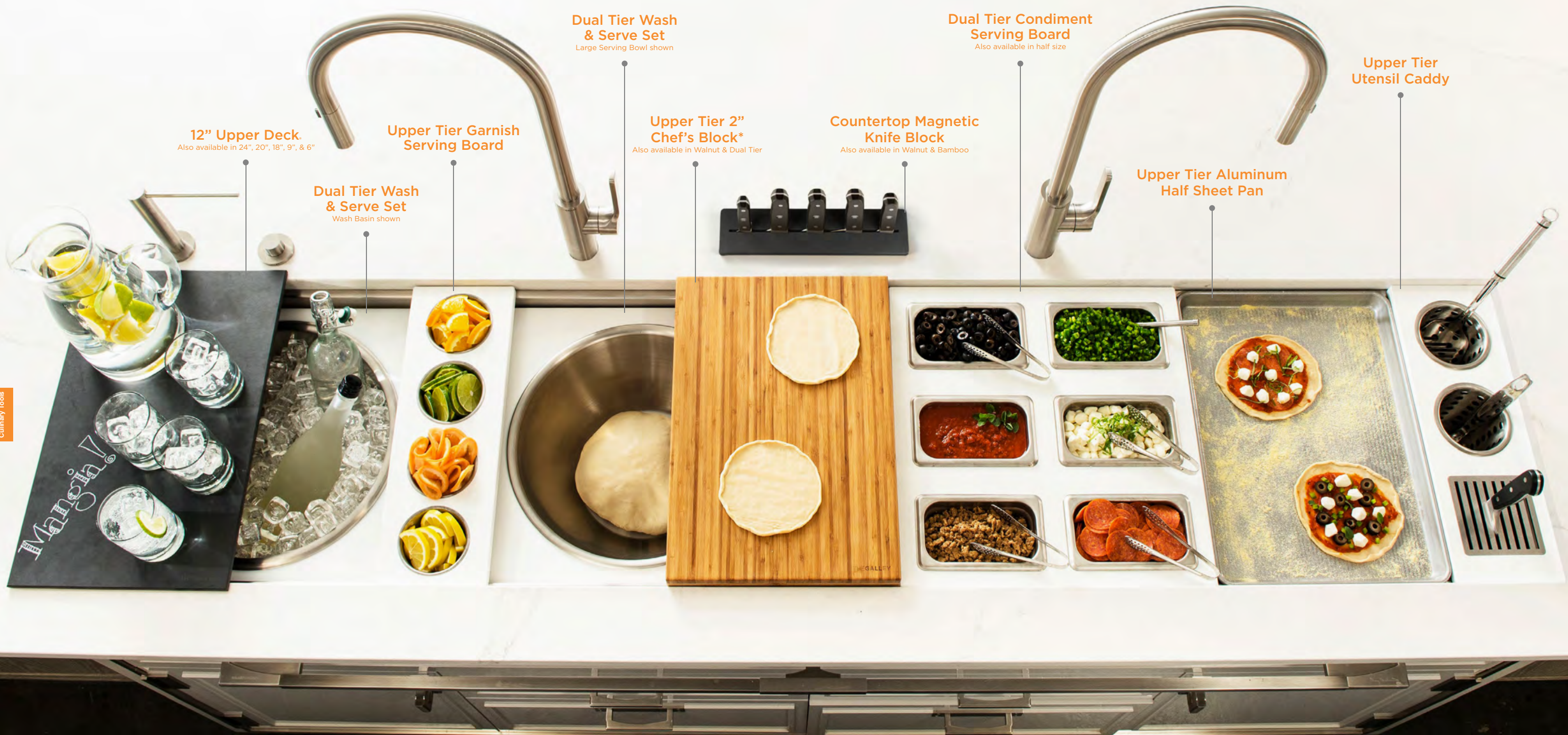

12" Upper Deck.
Also available in 24", 20", 18", 9", & 6"

Upper Tier Garnish Serving Board

Dual Tier Wash & Serve Set
Wash Basin shown

Dual Tier Wash & Serve Set
Large Serving Bowl shown

Upper Tier 2" Chef's Block*
Also available in Walnut & Dual Tier

Countertop Magnetic Knife Block
Also available in Walnut & Bamboo

Dual Tier Condiment Serving Board
Also available in half size

Upper Tier Aluminum Half Sheet Pan

Upper Tier Utensil Caddy

*2" Chef's Blocks include Juice Groove on one side
Upper Deck shown in Graphite Wood Composite and Optional Culinary Tools shown in Designer White Resin are available in all materials

Optional Culinary Tools

Dual Tier

2" Chef's Block

CH-17-D-WA

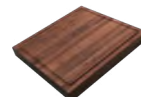

American Black Walnut
MSRP UMRP
\$600 \$540

CH-17-D-BA



Natural Golden Bamboo
MSRP UMRP
\$450 \$405

Specifications

2" thick
Sits proud of countertop less than 2" thick
Juice groove on one side
Height adjustable
17" x 18"

Wash & Serve Set

WM-17-D-WA



3/4" American Black Walnut
MSRP UMRP
\$575 \$518

WM-17-D-GT



1/2" Graphite Wood Composite
MSRP UMRP
\$500 \$450

WM-17-D-BA



3/4" Natural Golden Bamboo
MSRP UMRP
\$425 \$383

WM-17-D-GR



5/8" Exclusive Gray Resin*
MSRP UMRP
\$425 \$383

WM-17-D-WH



5/8" Designer White Resin*
MSRP UMRP
\$425 \$383

Specifications

Brushed stainless steel wash basin with drain & stopper 15 1/2" x 6 5/8"
Satin/mirrored stainless steel large serving bowl 14 7/8" x 5 1/2" 10.5 qt.
Height adjustable
Platform 17" x 18"

Condiment Serving Board

SB-17-D-WA

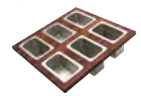

3/4" American Black Walnut
MSRP UMRP
\$425 \$383

SB-17-D-GT

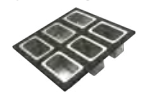

1/2" Graphite Wood Composite
MSRP UMRP
\$350 \$315

SB-17-D-BA

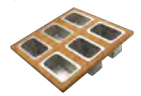

3/4" Natural Golden Bamboo
MSRP UMRP
\$275 \$248

SB-17-D-GR



5/8" Exclusive Gray Resin
MSRP UMRP
\$275 \$248

SB-17-D-WH

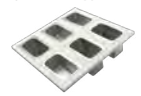

5/8" Designer White Resin*
MSRP UMRP
\$275 \$248

Specifications

6 stainless steel containers, 3 deep, 3 shallow, 6 lids
Height adjustable
Platform 17" x 18"

Lower Tier & Countertop

Mini Drying Rack

DR-06-L-WA



3/4" American Black Walnut
MSRP UMRP
\$275 \$248

DR-06-L-GT

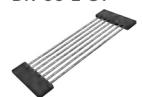

1/2" Graphite Wood Composite
MSRP UMRP
\$225 \$203

DR-06-L-BA



3/4" Natural Golden Bamboo
MSRP UMRP
\$175 \$158

DR-06-L-GR



5/8" Exclusive Gray Resin*
MSRP UMRP
\$175 \$158

DR-06-L-WH



5/8" Designer White Resin*
MSRP UMRP
\$175 \$158

Specifications

Stainless Steel rods**
6" x 17"

Recessed Knife Block

KB-03-C-WA



3/4" American Black Walnut
MSRP UMRP
\$250 \$225

KB-03-C-GT



1/2" Graphite Wood Composite
MSRP UMRP
\$175 \$158

KB-03-C-BA



3/4" Natural Golden Bamboo
MSRP UMRP
\$175 \$158

Specifications

Linear opening with a magnet to hold knives in place
Semi recessed (2 7/16" x 10 9/16" C.O.) or flush mounted (2 15/16" x 11 1/16" C.O. 3/16" radius)
2 7/8" x 11"

Upper Tier

2" Chef's Block

CH-12-U-WA



American Black Walnut
MSRP UMRP
\$525 \$473

CH-12-U-BA



Natural Golden Bamboo
MSRP UMRP
\$375 \$338

Specifications

2" thick
Sits proud of countertop less than 2" thick
Juice groove on one side
12 1/4" x 18"

Garnish Board

SB-06-U-WA



3/4" American Black Walnut
MSRP UMRP
\$350 \$315

SB-06-U-GT



1/2" Graphite Wood Composite
MSRP UMRP
\$300 \$270

SB-06-U-BA



3/4" Natural Golden Bamboo
MSRP UMRP
\$300 \$270

SB-06-U-GR



5/8" Exclusive Gray Resin*
MSRP UMRP
\$225 \$203

SB-06-U-WH



5/8" Designer White Resin*
MSRP UMRP
\$225 \$203

Specifications

4 small stainless steel bowls 4"
Platform 6" x 18"

Condiment Serving Board

SB-09-U-WA



3/4" American Black Walnut
MSRP UMRP
\$300 \$270

SB-09-U-GT

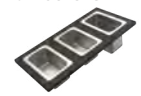

1/2" Graphite Wood Composite
MSRP UMRP
\$250 \$225

SB-09-U-BA

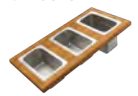

3/4" Natural Golden Bamboo
MSRP UMRP
\$200 \$180

SB-09-U-GR

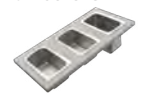

5/8" Exclusive Gray Resin
MSRP UMRP
\$200 \$180

SB-09-U-WH

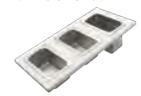

5/8" Designer White Resin*
MSRP UMRP
\$200 \$180

Specifications

3 stainless steel containers, 1 deep, 2 shallow, 3 lids
Platform 8 3/4" x 18"

Utensil Caddy

UC-06-U-WA



3/4" American Black Walnut
MSRP UMRP
\$275 \$248

UC-06-U-GT



1/2" Graphite Wood Composite
MSRP UMRP
\$225 \$203

UC-06-U-BA



3/4" Natural Golden Bamboo
MSRP UMRP
\$175 \$158

UC-06-U-GR



5/8" Exclusive Gray Resin*
MSRP UMRP
\$175 \$158

UC-06-U-WH



5/8" Designer White Resin*
MSRP UMRP
\$175 \$158

Specifications

2 stainless steel perforated cylinders
1 stainless steel grate
Platform 6" x 18"

Half Sheet Pan

HS-13-U-AL

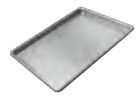

Aluminized Steel
MSRP UMRP
\$27 \$24

Specifications

Oven safe to 450°F
Non-stick coating
Fluted design that facilitates air circulation and resists warping
Made in the USA
13" x 18"

Color Coded Labels

-G, -B, -R



Green, Blue or Red
MSRP UMRP
\$50 \$45

Specifications

Add to one side of any Resin Cutting Board or Platform. Add -G or -B or -R at the end of product code. Ex: CB-17-D-WH-B
Note: Label on Cutting Board will be located on side without Juice Groove

*See Color Coded Labels

**Stainless Steel rod diameter: WA & BA: 3/8", GT: 1/4", GR & WH: 5/16"

***Upper Deck section sits above countertop: WA & BA: 1/2", GT: 1/4", GR & WH: 3/8"

Optional Culinary Tools

Specialty Kits

Entertain Kit Dual Tier Wash & Serve Set, Dual Tier Condiment Board, Upper Tier Garnish Board

EKT-4T-WA

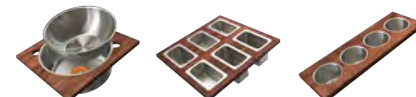

American Black Walnut
MSRP UMRP
\$1,250 \$1,125

EKT-4T-GT

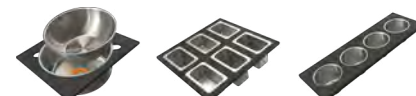

Graphite Wood Composite
MSRP UMRP
\$1,050 \$945

EKT-4T-BA

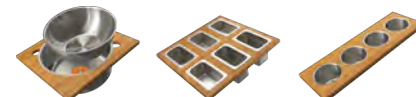

Natural Golden Bamboo
MSRP UMRP
\$1,050 \$945

EKT-4T-GR



Exclusive Gray Resin*
MSRP UMRP
\$850 \$765

EKT-4T-WH



Designer White Resin*
MSRP UMRP
\$850 \$765

Outdoor Kit Dual Tier Wash & Serve Set, Upper Tier Condiment Serving Board, Utensil Caddy, Half Sheet Pan

OKT-5T-GT

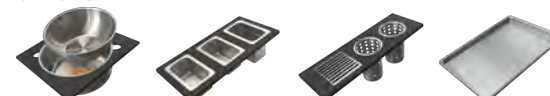

Graphite Wood Composite
MSRP UMRP
\$1,000 \$900

OKT-5T-GR



Exclusive Gray Resin*
MSRP UMRP
\$800 \$720

OKT-5T-WH



Designer White Resin*
MSRP UMRP
\$800 \$720

*See page 87 for Color Coded Labels

**Stainless Steel rod diameter: WA & BA: 3/8", GT: 1/4", GR & WH: 5/16"

***Upper Deck section sits above countertop: WA & BA: 1/2", GT: 1/4", GR & WH: 3/8"

Corner Upper & Lower Tier

2" Upper Tier Corner Chef's Block

CH-18-C-WA



American Black Walnut
MSRP UMRP
\$675 \$608

CH-18-C-BA



Natural Golden Bamboo
MSRP UMRP
\$525 \$473

Specifications

2" thick
Sits proud of countertop less than 2" thick
Juice groove on one side
18 1/4" x 18 1/4"

Upper Tier Corner Cutting Board

CB-18-C-WA



3/4" American Black Walnut
MSRP UMRP
\$400 \$360

CB-18-C-GT



1/2" Graphite Wood Composite
MSRP UMRP
\$300 \$270

CB-18-C-BA



3/4" Natural Golden Bamboo
MSRP UMRP
\$300 \$270

CB-18-C-GR



5/8" Exclusive Gray Resin*
MSRP UMRP
\$225 \$203

CB-18-C-WH



5/8" Designer White Resin*
MSRP UMRP
\$225 \$203

Specifications

Juice groove on one side
18 1/4" x 18 1/4"

Lower Tier Corner Wash & Serve Set

WM-17-C-WA



3/4" American Black Walnut
MSRP UMRP
\$600 \$540

WM-17-C-GT



1/2" Graphite Wood Composite
MSRP UMRP
\$525 \$473

WM-17-C-BA



3/4" Natural Golden Bamboo
MSRP UMRP
\$450 \$405

WM-17-C-GR



5/8" Exclusive Gray Resin*
MSRP UMRP
\$450 \$405

WM-17-C-WH



5/8" Designer White Resin*
MSRP UMRP
\$450 \$405

Specifications

Brushed stainless steel wash basin with drain & stopper 15 1/2" x 6 5/8"
Satin/mirrored stainless steel large serving bowl 14 7/8" x 5

Optional Culinary Tools

Included with Large Culinary Kits

18" Upper Deck

UD-18-I-WA	UD-18-I-GT	UD-18-I-BA	UD-18-I-GR	UD-18-I-WH
				
MSRP UMRP	MSRP UMRP	MSRP UMRP	MSRP UMRP	MSRP UMRP
\$325 \$293	\$225 \$203		\$150 \$135	

Specifications

18" Upper Deck section
19" deep
Cover system and third tier work surface
Sits in 18" deep***
Requires 1/4" clearance below countertop surface

Dual Tier Drying Rack

DR-17-D-WA	DR-17-D-GT	DR-17-D-BA	DR-17-D-GR	DR-17-D-WH
				
MSRP UMRP	MSRP UMRP	MSRP UMRP	MSRP UMRP	MSRP UMRP
\$375 \$338	\$325 \$293		\$250 \$225	

Specifications

Stainless Steel rods**
Height adjustable
17" x 18"

Dual Tier Colander & Mixing Bowl

BC-17-D-WA	BC-17-D-GT	BC-17-D-BA	BC-17-D-GR	BC-17-D-WH
				
MSRP UMRP	MSRP UMRP	MSRP UMRP	MSRP UMRP	MSRP UMRP
\$375 \$338	\$300 \$270		\$250 \$225	

Specifications

Satin/mirrored stainless steel
Colander & Mixing Bowl w/ lid 11" x 6 5/16"
7.2 qt.
Height adjustable
17" x 18"

Dual Tier Cutting Board

CB-17-D-WA	CB-17-D-GT	CB-17-D-BA	CB-17-D-GR	CB-17-D-WH
				
MSRP UMRP	MSRP UMRP	MSRP UMRP	MSRP UMRP	MSRP UMRP
\$375 \$338	\$275 \$248		\$200 \$180	

Specifications

Juice groove on one side
Height adjustable
17" x 18"

Included with Small Culinary Kits

12" Upper Deck

UD-12-I-WA	UD-12-I-GT	UD-12-I-BA	UD-12-I-GR	UD-12-I-WH
				
MSRP UMRP	MSRP UMRP	MSRP UMRP	MSRP UMRP	MSRP UMRP
\$300 \$270	\$200 \$180		\$125 \$113	

Specifications

12" Upper Deck section
19" deep
Cover system and third tier work surface
Sits in 18" deep***
Requires 1/4" clearance below countertop surface

Upper Tier Drying Rack

DR-12-U-WA	DR-12-U-GT	DR-12-U-BA	DR-12-U-GR	DR-12-U-WH
				
MSRP UMRP	MSRP UMRP	MSRP UMRP	MSRP UMRP	MSRP UMRP
\$325 \$293	\$275 \$248		\$225 \$203	

Specifications

Stainless Steel rods**
12 1/4" x 18"

Lower Tier Colander & Mixing Bowl

BC-12-L-WA	BC-12-L-GT	BC-12-L-BA	BC-12-L-GR	BC-12-L-WH
				
MSRP UMRP	MSRP UMRP	MSRP UMRP	MSRP UMRP	MSRP UMRP
\$350 \$315	\$275 \$248		\$225 \$203	

Specifications

Satin/mirrored stainless steel
Colander & Mixing Bowl w/ lid 11" x 6 5/16"
7.2 qt.
12 1/4" x 17"

Upper Tier Cutting Board

CB-12-U-WA	CB-12-U-GT	CB-12-U-BA	CB-12-U-GR	CB-12-U-WH
				
MSRP UMRP	MSRP UMRP	MSRP UMRP	MSRP UMRP	MSRP UMRP
\$350 \$315	\$250 \$225		\$175 \$158	

Specifications

Juice groove on one side
12 1/4" x 18"

Optional Culinary Tools

Included with Wash Kits

Upper Tier Drying Rack

DR-09-U-WA	DR-09-U-GT	DR-09-U-BA	DR-09-U-GR	DR-09-U-WH
				
MSRP UMRP	MSRP UMRP	MSRP UMRP	MSRP UMRP	MSRP UMRP
\$325 \$293	\$275 \$248		\$225 \$203	

Specifications

Stainless Steel rods**
9 1/4" x 18"

Upper Tier Utensil Caddy

UC-06-U-WA	UC-06-U-GT	UC-06-U-BA	UC-06-U-GR	UC-06-U-WH
				
MSRP UMRP	MSRP UMRP	MSRP UMRP	MSRP UMRP	MSRP UMRP
\$275 \$248	\$225 \$203		\$175 \$158	

Specifications

2 stainless steel perforated cylinders
1 stainless steel grate
Platform 6" x 18"

Lower Tier Wash Caddy

WC-06-L-GT	WC-06-L-GR	WC-06-L-WH
		
MSRP UMRP	MSRP UMRP	MSRP UMRP
\$185 \$167		

Specifications

Removable drip tray
Polypropylene
6" x 17"

Lower Tier Wash Bowl

WB-12-L-GT	WB-12-L-GR	WB-12-L-WH
		
MSRP UMRP	MSRP UMRP	MSRP UMRP
\$215 \$194		

Specifications

Removable pop-up drain
Polypropylene
12" x 17"

Included with Bar Kits

6" Upper Deck

UD-06-I-WA	UD-06-I-GT	UD-06-I-BA	UD-06-I-GR	UD-06-I-WH
				
MSRP UMRP	MSRP UMRP	MSRP UMRP	MSRP UMRP	MSRP UMRP
\$275 \$248	\$175 \$158		\$100 \$90	

Specifications

6" Upper Deck section
19" deep
Cover system and third tier work surface
Sits in 18" deep***
Requires 1/4" clearance below countertop surface

Upper Tier Garnish Board

SB-06-U-WA	SB-06-U-GT	SB-06-U-BA	SB-06-U-GR	SB-06-U-WH
				
MSRP UMRP	MSRP UMRP	MSRP UMRP	MSRP UMRP	MSRP UMRP
\$350 \$315	\$300 \$270		\$225 \$203	

Specifications

4 small stainless steel bowls 4"
Platform 6" x 18"

Lower Tier Mini Drying Rack

DR-06-L-WA	DR-06-L-GT	DR-06-L-BA	DR-06-L-GR	DR-06-L-WH
				
MSRP UMRP	MSRP UMRP	MSRP UMRP	MSRP UMRP	MSRP UMRP
\$275 \$248	\$225 \$203		\$175 \$158	

Specifications

Stainless Steel rods**
6" x 17"

*See page 87 for Color Coded Labels

**Stainless Steel rod diameter: WA & BA: 3/8", GT: 1/4", GR & WH: 5/16"

***Upper Deck section sits above countertop: WA & BA: 1/2", GT: 1/4", GR & WH: 3/8"

[Order Form](#)

*See page 87 for Color Coded Labels

**Stainless Steel rod diameter: WA & BA: 3/8", GT: 1/4", GR & WH: 5/16"

***Upper Deck section sits above countertop: WA & BA: 1/2", GT: 1/4", GR & WH: 3/8"

[Order Form](#)

Individual

Stainless Steel Clean + Polish

CIT-09-SS-C



9 fl oz Stainless Steel Clean + Polish
Individual bottle

MSRP	UMRP
\$33	\$30

Ingredients

<5% Anionic Surfactants, <5% Non-Ionic Surfactants, <5% Phosphates.
Contains Preservation Agents. Other Ingredients: Auxiliary Agents, Perfumes

Wood Condition + Protect

CIT-09-WD-C



9 fl oz Wood Condition + Protect
Individual bottle

MSRP	UMRP
\$25	\$23

Ingredients

Mineral Oil, Vitamin E, Beeswax

Wood Finishing Balm

CIT-04-WD-B



4 oz Wood Finishing Balm
Individual Tin

MSRP	UMRP
\$22	\$20

Ingredients

Mineral Oil, Vitamin E, Beeswax

Cases

Stainless Steel Clean + Polish

CIT-09-SS-C-CS



9 fl oz Stainless Steel Clean + Polish
Case of 12 bottles

MSRP	UMRP
\$375	\$338

Ingredients

<5% Anionic Surfactants, <5% Non-Ionic Surfactants, <5% Phosphates.
Contains Preservation Agents. Other Ingredients: Auxiliary Agents, Perfumes

Wood Condition + Protect

CIT-09-WD-C-CS



9 fl oz Wood Condition + Protect
Case of 12 bottles

MSRP	UMRP
\$300	\$270

Ingredients

Mineral Oil, Vitamin E, Beeswax

Wood Finishing Balm

CIT-04-WD-B-CS



4 oz Wood Finishing Balm
Case of 12 Tins

MSRP	UMRP
\$250	\$225

Ingredients

Mineral Oil, Vitamin E, Beeswax

citrine Stainless Steel Clean + Polish

Use on Workstation Basin

Gentle, food-safe

Restores shine and luster

Removes debris and tarnish

Protects cleaned surface

citrine Wood Condition + Protect

Use first on Walnut or Bamboo Tools

Gentle, food-safe

Natural earth friendly

Moisturizes with organic ingredients

Preserves natural beauty of wood

citrine Wood Finishing Balm

Use second on Walnut or Bamboo Tools

Gentle, food-safe

Natural earth friendly

Moisturizes with organic ingredients

Preserves natural beauty of wood



THE GALLEY TAP[®]

The perfect pair

The Galley Tap is the first and only kitchen faucet thoughtfully designed, engineered, and manufactured to function perfectly with a specific line of kitchen sinks, or in our case, kitchen workstations. Simply put, it completes The Galley Workstation.

"Its striking beauty comes from its perfect geometry. That's the magic!"

David Kotowsky
Designer | Galley Tap

The Galley Tap

The Galley Tap

Ideal Workstation 7S with Graphite Wood Composite Culinary Kit, Polished Stainless Steel Taps, Hot & Cold Tap, Soap Dispenser, and Deck Switch

THE IDEAL KITCHEN FAUCET

This stunning kitchen faucet has been ergonomically designed and engineered with dimensions that are specifically suited for the Galley Workstation. The Galley Ideal Tap, along with the BarTap, Hot & Cold Tap, and Pot Filler Tap, is perfectly proportioned, functional and beautiful. The Soap Dispenser and Deck Switch are the perfect companions to the Tap and Workstation.

Limited Lifetime Mechanical and Finish Warranty



IDEAL FLOW.
LAMINAR

IDEAL FLOW.
SPRAY

ERGONOMIC SLIDE SWITCH TO SELECT
IDEAL FLOW, LAMINAR OR SPRAY

HAND SPRAY EXTENDS UP TO 26" FROM SPOUT

11" POT FILL HEIGHT FROM
COUNTERTOP TO SPOUT OUTLET

Q-DOCK™ DOCKING SYSTEM
HOLDS HAND SPRAY IN PLACE

3" LONG HAND SPRAY FITS
COMFORTABLY IN YOUR HAND

CONCEALED EASY CLEAN SPRAY FACE

5 1/2" HEIGHT FROM
DECK TO SPOUT OUTLET

11" CENTERSTATION™
SPOUT PROJECTION

5 1/2" SPOUT
PROJECTION

EASY REFILL
FROM TOP

ABOVE DECK
DESIGN

SPOUT ROTATES 360°

FORWARD-ROTATING
COMFORTFEEL™ LEVER HANDLE

SOLID 316L MACHINED STAINLESS STEEL
CONSTRUCTION INDOOR/OUTDOOR

OPTIONAL BASE RING INCLUDED



WATER FILTRATION
SYSTEM

The Galley Tap

The Galley Tap

WORLD CLASS QUALITY

State-of-the-art quality and manufacturing precision is evident throughout every millimeter of the Galley Tap® line. Machined out of solid AISI 316L Stainless Steel, this dynamic faucet is ideal for both indoor and outdoor use.

The Galley Tap and accompanying BarTap®, Hot & Cold Tap, Pot Filler Tap, Soap Dispenser and Deck Switch are available in six flawless Stainless Steel finishes: Matte, Polished, PVD Gun Metal Gray™, PVD Satin Black, PVD Brushed Gold*, and PVD Polished Rose Gold*.



GALLEY PVD A suit of armor

The Physical Vapor Deposition (PVD) process vaporizes a solid metal to a plasma of atoms or molecules; the vapor is then deposited in a vacuum chamber as a high-performance coating. Used in the aerospace and biomedical fields, PVD is the hardest and most corrosion-resistant coating to strengthen and protect your Tap for a lifetime. It is more environmentally friendly than traditional coating processes such as electroplating and powder coating.

Polished Stainless Steel

Matte Stainless Steel

PVD Gun Metal Gray™ Stainless Steel

PVD Satin Black Stainless Steel

PVD Brushed Gold* Stainless Steel

PVD Polished Rose Gold* Stainless Steel

Classic Finishes

Premium Finishes

Prestige Finishes

*Limited Edition

Ideal Tap with Filtration

High Flow (HF) or Eco Flow (EF)



Specifications

- Ideal Tap**
 Single-lever control ceramic disk cartridge
 Forward rotating COMFORTFEEL™ lever handle
 11" CENTERSTATION™ spout projection
 11" Pot fill height from deck to spout outlet
 Hand spray extends up to 26" from spout
 Q-Dock™ docking system holds hand spray in place
 Ergonomic slide switch to select Ideal Flow. Laminar or Spray Flow
 Automatic return to laminar flow
 Concealed easy clean spray face
 Spout rotates 360°
 Quiet, smooth gliding hose
 Counterweight
 Dual check valves
 24" stainless steel flexible hoses 3/8" compression
 Maximum counter thickness 2"
 Minimum install hole diameter 1 3/8"
 Optional base ring included
 Total height 21 1/4"
 High Flow 2.2 GPM maximum flow rate
 Eco Flow 1.8 GPM maximum flow rate
 For use with Water Filtration System* (included)
 *Note: May reduce water flow

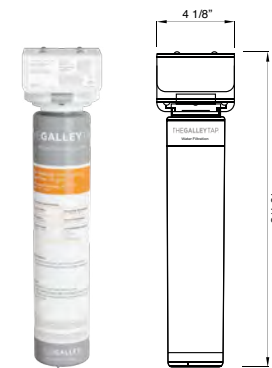

Water Filtration System (Included)

- Water Filtration System**
 Service flow rate 2.0 gpm
 Rated capacity 7,900 gallons
 Operating pressure 10 - 125 psi
 Operating temperature 35 - 100°F
 Overall dimensions 16 7/8" x 4 1/8"
 Reduces lead, chlorine, cysts and other contaminants
 Quick twist-lock cartridge replacement
 Replacement filter cartridge dimensions 14 1/2" x 3"
 Internal parts never exposed to human handling
 Filtration protects capital equipment from early breakdown
 Installs vertically (allow 2 1/2" clearance)
 Parts Included: Mounting bracket and screws, plastic tubing, push-fit Tee

Construction

- Ideal Tap**
 Solid 316L machined stainless steel construction
 Available in Polished, Matte, PVD Gun Metal Gray™, PVD Satin Black, PVD Brushed Gold, PVD Polished Rose Gold
 Indoor & outdoor
 Limited Lifetime Warranty
 Made in Italy

- Water Filtration System**
 Five Year Warranty
 Made in the USA

Codes/Standards

- Ideal Tap**
 ASME 112.18.1
 CSA B125.1
 NSF 61, 372
 CALGreen
 cUPC
 ADA

- Water Filtration System**
 IAPMO Certified
 NSF/ANSI 42, 53, 372

For Tap Accessories see pages 109-110

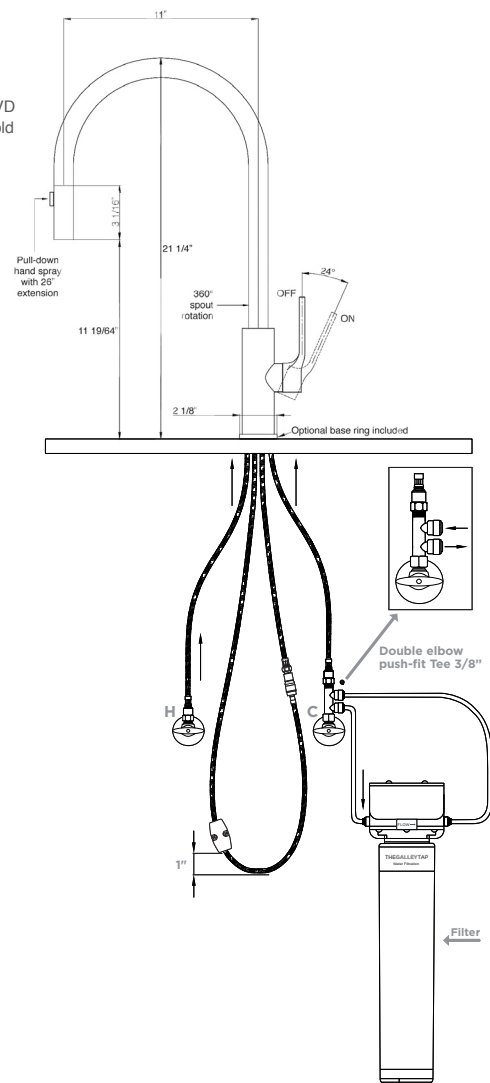

Ideal Tap

High Flow (HF) or Eco Flow (EF)



Specifications

- Single-lever control ceramic disk cartridge
 Forward rotating COMFORTFEEL™ lever handle
 11" CENTERSTATION™ spout projection
 11" Pot fill height from deck to spout outlet
 Hand spray extends up to 26" from spout
 Q-Dock™ docking system holds hand spray in place
 Ergonomic slide switch to select Ideal Flow. Laminar or Spray Flow
 Automatic return to laminar flow
 Concealed easy clean spray face
 Spout rotates 360°
 Quiet, smooth gliding hose
 Counterweight
 Dual check valves
 24" stainless steel flexible hoses 3/8" compression
 Maximum counter thickness 2"
 Minimum install hole diameter 1 3/8"
 Optional base ring included
 Total height 21 1/4"
 High Flow 2.2 GPM maximum flow rate
 Eco Flow 1.8 GPM maximum flow rate
 For use with Water Filtration System* (not included)
 *Note: May reduce water flow

Construction

- Solid 316L machined stainless steel construction
 Available in Polished, Matte, PVD Gun Metal Gray™, PVD Satin Black, PVD Brushed Gold, PVD Polished Rose Gold
 Indoor & outdoor
 Limited Lifetime Warranty
 Made in Italy

Codes/Standards

- ASME 112.18.1
 CSA B125.1
 NSF 61, 372
 CALGreen
 cUPC
 ADA

For Tap Accessories see pages 109-110

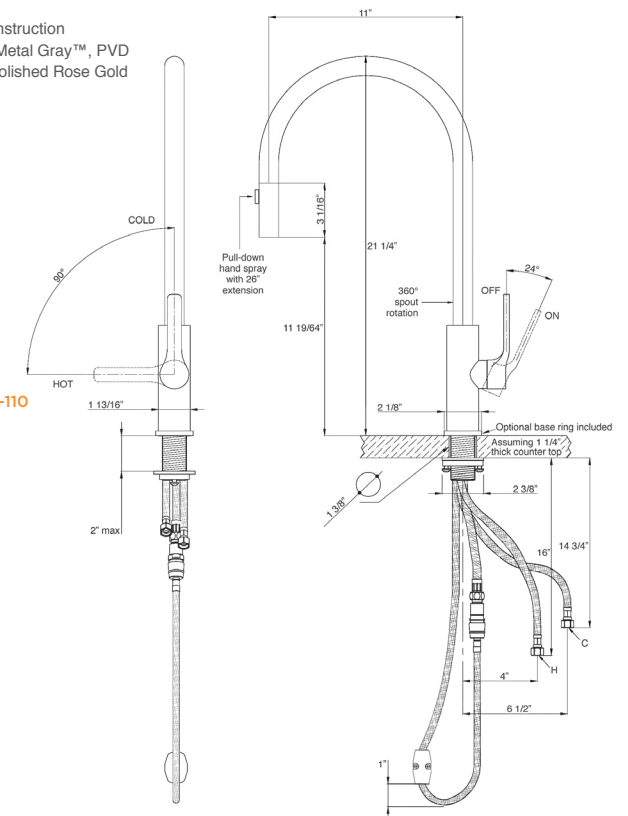

Ideal BarTap® with Filtration

High Flow (HF) or Eco Flow (EF)



Specifications

Ideal BarTap
 Single-lever control
 Ceramic disk cartridge
 Forward rotating COMFORTFEEL™ lever handle
 Q-Dock™ docking system holds hand spray in place
 Ergonomic slide switch to select Ideal Flow. Laminar or Spray Flow
 Automatic return to laminar flow
 Concealed easy clean spray face
 Spout rotates 360°
 Counterweight
 Dual check valves
 24" stainless steel flexible hoses 3/8" compression
 Maximum counter thickness 2"
 Minimum install hole diameter 1 3/8"
 Optional base ring included
 Total height 15 13/16"
 High Flow 2.2 GPM maximum flow rate
 Eco Flow 1.8 GPM maximum flow rate
 For use with Water Filtration System* (included)
 *Note: May reduce water flow

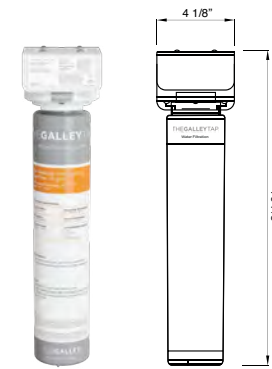

Water Filtration System (included)

Water Filtration System
 Service flow rate 2.0 gpm
 Rated capacity 7,900 gallons
 Operating pressure 10 - 125 psi
 Operating temperature 35 - 100°F
 Overall dimensions 16 7/8" x 4 1/8"
 Reduces lead, chlorine, cysts and other contaminants
 Quick twist-lock cartridge replacement
 Replacement filter cartridge dimensions 14 1/2" x 3"
 Internal parts never exposed to human handling
 Filtration protects capital equipment from early breakdown
 Installs vertically (allow 2 1/2" clearance)
 Parts Included: Mounting bracket and screws, plastic tubing, push-fit Tee

Construction

Ideal BarTap
 Solid 316L machined stainless steel construction
 Available in Polished, Matte, PVD Gun Metal Gray™, PVD Satin Black, PVD Brushed Gold, PVD Polished Rose Gold
 Indoor & outdoor
 Limited Lifetime Warranty
 Made in Italy

Water Filtration System
 Five Year Warranty
 Made in the USA

Codes/Standards

Ideal BarTap
 ASME 112.18.1
 CSA B125.1
 NSF 61, 372
 CALGreen
 cUPC
 ADA

Water Filtration System
 IAPMO Certified
 NSF/ANSI 42, 53, 372

For Tap Accessories see pages 109-110

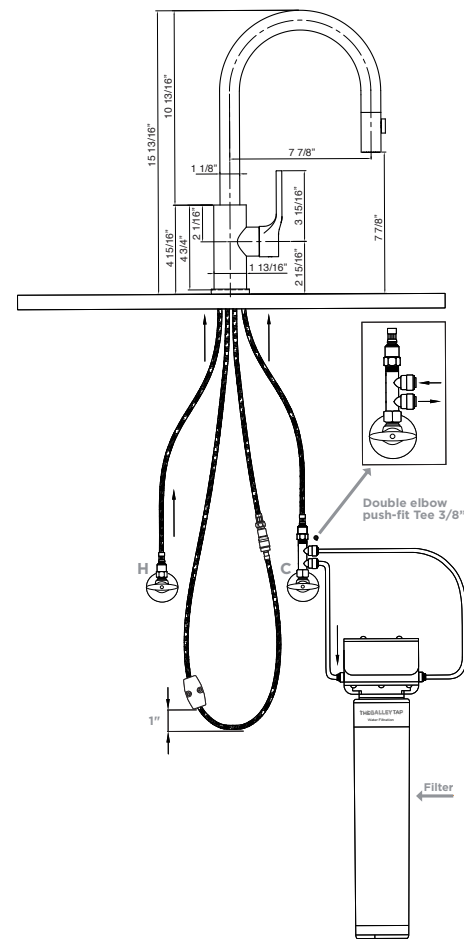

Ideal BarTap®

High Flow (HF) or Eco Flow (EF)



Specifications

Single-lever control
 Ceramic disk cartridge
 Forward rotating COMFORTFEEL™ lever handle
 Q-Dock™ docking system holds hand spray in place
 Ergonomic slide switch to select Ideal Flow. Laminar or Spray Flow
 Automatic return to laminar flow
 Concealed easy clean spray face
 Spout rotates 360°
 Counterweight
 Dual check valves
 24" stainless steel flexible hoses 3/8" compression
 Maximum counter thickness 2"
 Minimum install hole diameter 1 3/8"
 Optional base ring included
 Total height 15 13/16"
 High Flow 2.2 GPM maximum flow rate
 Eco Flow 1.8 GPM maximum flow rate
 For use with Water Filtration System* (not included)
 *Note: May reduce water flow

Construction

Solid 316L machined stainless steel construction
 Available in Polished, Matte, PVD Gun Metal Gray™, PVD Satin Black, PVD Brushed Gold, PVD Polished Rose Gold
 Indoor & outdoor
 Limited Lifetime Warranty
 Made in Italy

Codes/Standards

ASME 112.18.1
 CSA B125.1
 NSF 61, 372
 CALGreen
 cUPC
 ADA

For Tap Accessories see pages 109-110

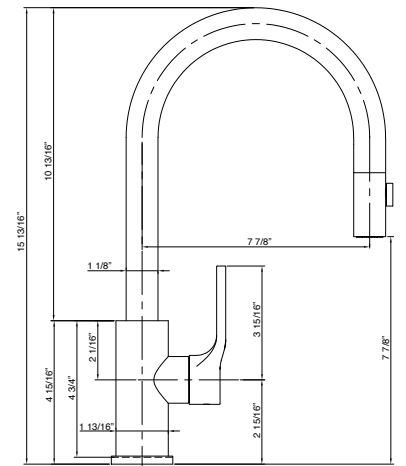

THE IDEAL HOT & COLD TAP

Filtered Instant Hot + Cold Water System

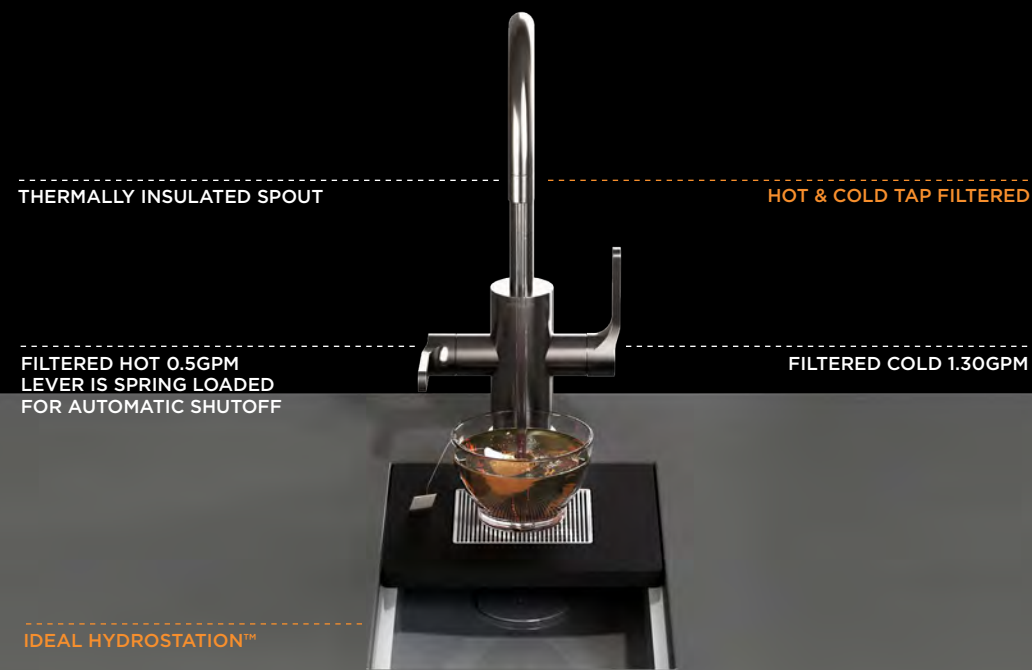

THERMALLY INSULATED SPOUT

HOT & COLD TAP FILTERED

FILTERED HOT 0.5GPM
LEVER IS SPRING LOADED
FOR AUTOMATIC SHUTOFF

FILTERED COLD 1.30GPM

IDEAL HYDROSTATION™



DIGITAL HOT WATER TANK
CAPACITY: 60 CUPS/HOUR
ADJUST TEMP: 167°-208°F

<0.5 MICRON COMMERCIAL
GRADE FILTRATION SYSTEM
2.0GPM | 7,900 GALLONS

DRINK

- Filtered Water
- Instant Coffee
- Hot Tea
- Fruit Infused Water



COOK

- Poach Eggs
- Blanch Vegetables
- Pasta & Rice
- Instant Oatmeal

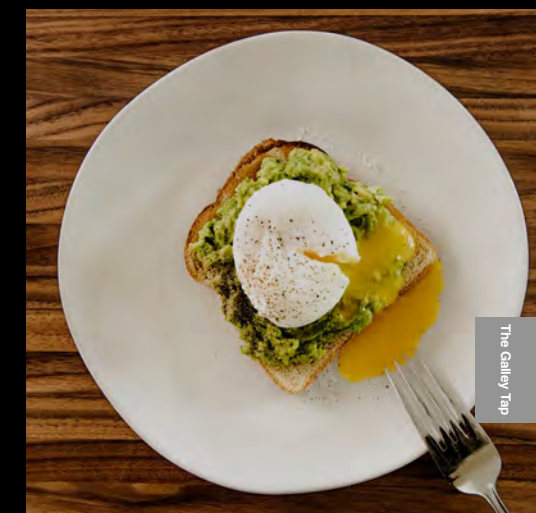

CLEAN

- Greasy Pans
- Cutting Boards
- Wash Dishes
- Sterilize Baby Bottles



Ideal Hot & Cold Tap with Filtration



Specifications

Ideal Hot & Cold Tap
 Solid 316L Machined Stainless Steel Construction
 Forward rotating COMFORTFEEL™ lever handles
 Hot side lever is spring loaded for automatic shutoff 1/4 turn
 Ceramic disk cartridges
 Spout rotates 360°
 Laminar Ideal Flow.
 Thermally insulated spout
 Provides filtered (included), hot water, 208°F max temperature
 Provides filtered (included), cold water (not chilled)
 Optional base ring included
 8 7/8" fill height from deck to spout outlet
 Total height 13 1/4"
 .50 GPM maximum flow rate for hot water
 1.30 GPM maximum flow rate for cold (not chilled) water
 Maximum counter thickness 2 1/4"
 Minimum install hole diameter 1 3/8"
 Compatible with reverse osmosis filtration systems
 Limited Lifetime Mechanical and Finish Warranty
 For use with Water Filtration System* (included)
 For use with Ideal Hot Water Tank™ (included)
 *Note: May reduce water flow

Construction

Ideal Hot & Cold Tap
 Solid 316L machined stainless steel construction
 Available in Polished, Matte, PVD Gun Metal Gray™, PVD Satin Black, PVD Brushed Gold, PVD Polished Rose Gold
 Indoor & outdoor
 Limited Lifetime Warranty
 Made in Italy

Ideal Hot Water Tank
 304 stainless steel tank 0.6 USG (2.4 litres)
 Five Year Warranty

Water Filtration System
 Five Year Warranty
 Made in the USA

Codes/Standards

Ideal Hot & Cold Tap
 ASME 112.18.1
 NSF/ANSI/CAN 61
 CSA B125.1
 cUPC
 ADA

Ideal Hot Water Tank
 UL Certified

Water Filtration System
 IAPMO Certified
 NSF/ANSI 42, 53, 372

For Tap Accessories see pages 109-110



Water Filtration System
 Service flow rate 2.0 gpm
 Rated capacity 7,900 gallons
 Operating pressure 10 - 125 psi
 Operating temperature 35 - 100°F
 Overall dimensions 16 7/8" x 4 1/8"
 Reduces lead, chlorine, cysts and other contaminants
 Quick twist-lock cartridge replacement
 Replacement filter cartridge dimensions 14 1/2" x 3"
 Internal parts never exposed to human handling
 Filtration protects capital equipment from early breakdown
 Installs vertically (allow 2 1/2" clearance)
 Parts Included: Mounting bracket and screws, plastic tubing, push-fit Tee

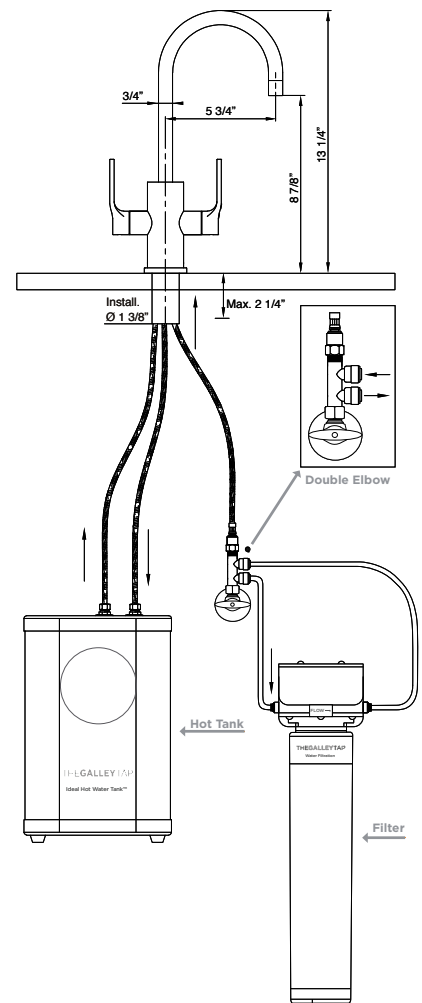

[Online Specification Page](#)
[Order Form](#)

Ideal Hot & Cold Tap



Specifications

Ideal Hot & Cold Tap
 Solid 316L Machined Stainless Steel Construction
 Forward rotating COMFORTFEEL™ lever handles
 Hot side lever is spring loaded for automatic shutoff 1/4 turn
 Ceramic disk cartridges
 Spout rotates 360°
 Laminar Ideal Flow.
 Thermally insulated spout
 Provides filtered (not included), hot water, 208°F max temperature
 Provides filtered (not included), cold water (not chilled)
 Optional base ring included
 8 7/8" fill height from deck to spout outlet
 Total height 13 1/4"
 .50 GPM maximum flow rate for hot water
 1.30 GPM maximum flow rate for cold (not chilled) water
 Maximum counter thickness 2 1/4"
 Minimum install hole diameter 1 3/8"
 Compatible with reverse osmosis filtration systems
 Limited Lifetime Mechanical and Finish Warranty
 For use with Water Filtration System* (not included)
 For use with Ideal Hot Water Tank™ (included)
 *Note: May reduce water flow

Construction

Ideal Hot & Cold Tap
 Solid 316L machined stainless steel construction
 Available in Polished, Matte, PVD Gun Metal Gray™, PVD Satin Black, PVD Brushed Gold, PVD Polished Rose Gold
 Indoor & outdoor
 Limited Lifetime Warranty
 Made in Italy

Ideal Hot Water Tank
 304 stainless steel tank 0.6 USG (2.4 litres)
 Five Year Warranty

Codes/Standards

Ideal Hot & Cold Tap
 ASME 112.18.1
 NSF/ANSI/CAN 61
 CSA B125.1
 cUPC
 ADA

Ideal Hot Water Tank
 UL Certified

For Tap Accessories see pages 109-110

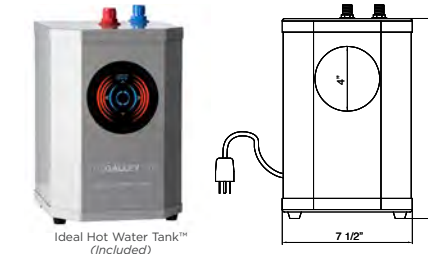

Ideal Hot Water Tank
 Digital control touch panel
 Adjustable temperature settings = 3° increments
 Seven preset temperatures = 167°-208°F
 Digital temperature control within 1-2°
 On/off button with vacation mode feature
 1500 watt/120-volt ceramic encased rapid-recovery element
 60 cups per hour capacity
 Standby reheat feature with low energy consumption 1W
 Standby reheat at 6° temperature-drop
 Built-in dry Burn and overheat sensors
 Built-in 60 psi RV with patented Baffle Fill System
 Encased element prevents limescale build-up
 Double venturi reduces faucet "dripping/spitting"
 Compatible with reverse osmosis filtration systems
 Space-saving 7 1/2" W x 7 1/2" D x 10 3/4" H
 Cabinet-side or floor-mount install options
 Parts Included: Silicone Washers, Adapters

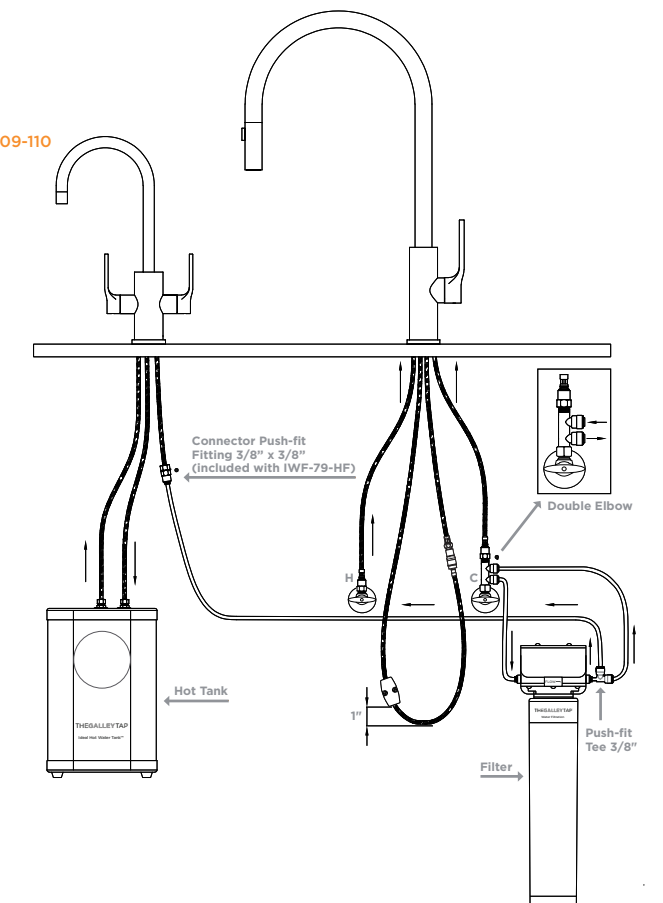
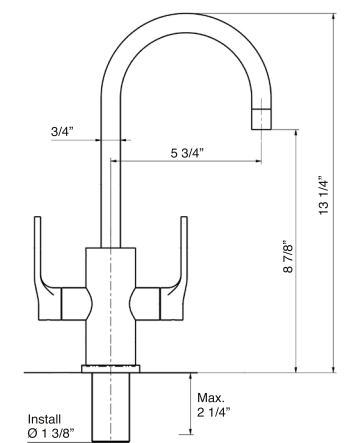

[Online Specification Page](#)
[Order Form](#)

Ideal Pot Filler Tap with Filtration

IPTF-D-PSS		IPTF-D-MSS		IPTF-D-GSS		IPTF-D-BSS		IPTF-D-YSS		IPTF-D-RSS	
Polished Stainless Steel	Matte Stainless Steel	PVD Gun Metal Gray™ Stainless Steel	PVD Satin Black Stainless Steel	PVD Brushed Gold Stainless Steel Limited Edition	PVD Polished Rose Gold Stainless Steel Limited Edition						
MSRP	UMRP	MSRP	UMRP	MSRP	UMRP	MSRP	UMRP	MSRP	UMRP	MSRP	UMRP
\$1,995	\$1,596	\$2,595	\$2,076	\$2,895	\$2,316						

Specifications

Ideal Pot Filler Tap
 Single-lever control
 1/4 turn ceramic disc valve cartridge
 COMFORTFEEL™ lever handle
 Cold water valve, one inlet
 Rough-in part required (sold separately)
 Laminar Ideal Flow.
 Dual swivel spout
 24" projection
 4.2 GPM
 For use with Water Filtration System* (included)
 *Note: May reduce water flow

Construction

Ideal Pot Filler Tap
 Solid 316L machined stainless steel construction
 Available in Polished, Matte, PVD Gun Metal Gray™, PVD Satin Black, PVD Brushed Gold, PVD Polished Rose Gold
 Indoor & outdoor
 Limited Lifetime Warranty
 Made in Italy

Water Filtration System
 Five Year Warranty
 Made in the USA

Rough-in

PFT-RO-SS
 Required Rough-in Part
 MSRP UMRP
 \$300 \$240

Codes/Standards

Ideal Pot Filler Tap
 NSF
 cUPC

Water Filtration System
 IAPMO Certified
 NSF/ANSI 42, 53, 372

For Tap Accessories see pages 109-110

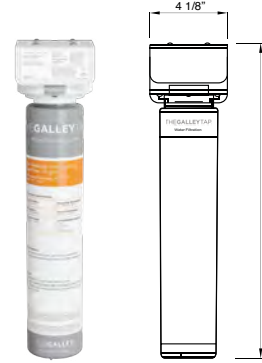

Water Filtration System (included)

Water Filtration System
 Service flow rate 2.0 gpm
 Rated capacity 7,900 gallons
 Operating pressure 10 - 125 psi
 Operating temperature 35 - 100°F
 Overall dimensions 16 7/8" x 4 1/8"
 Reduces lead, chlorine, cysts and other contaminants
 Quick twist-lock cartridge replacement
 Replacement filter cartridge dimensions 14 1/2" x 3"
 Internal parts never exposed to human handling
 Filtration protects capital equipment from early breakdown
 Installs vertically (allow 2 1/2" clearance)
 Parts Included: Mounting bracket and screws, plastic tubing, push-fit Tee

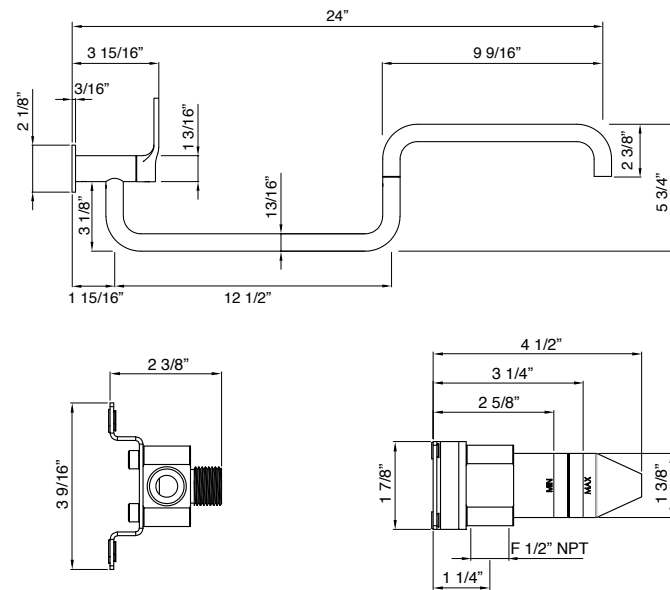

Ideal Pot Filler Tap

IPT-D-PSS		IPT-D-MSS		IPT-D-GSS		IPT-D-BSS		IPT-D-YSS		IPT-D-RSS	
Polished Stainless Steel	Matte Stainless Steel	PVD Gun Metal Gray™ Stainless Steel	PVD Satin Black Stainless Steel	PVD Brushed Gold Stainless Steel Limited Edition	PVD Polished Rose Gold Stainless Steel Limited Edition						
MSRP	UMRP	MSRP	UMRP	MSRP	UMRP	MSRP	UMRP	MSRP	UMRP	MSRP	UMRP
\$1,775	\$1,420	\$2,375	\$1,900	\$2,675	\$2,140						

Specifications

Single-lever control
 1/4 turn ceramic disc valve cartridge
 COMFORTFEEL™ lever handle
 Cold water valve, one inlet
 Rough-in part required (sold separately)
 Laminar Ideal Flow.
 Dual swivel spout
 24" projection
 4.2 GPM
 For use with Water Filtration System* (not included)
 *Note: May reduce water flow

Construction

Solid 316L machined stainless steel construction
 Available in Polished, Matte, PVD Gun Metal Gray™, PVD Satin Black, PVD Brushed Gold, PVD Polished Rose Gold
 Indoor & outdoor
 Limited Lifetime Warranty
 Made in Italy

Codes/Standards

NSF
 cUPC

For Tap Accessories see pages 109-110

Rough-in

PFT-RO-SS
 Required Rough-in Part
 MSRP UMRP
 \$300 \$240

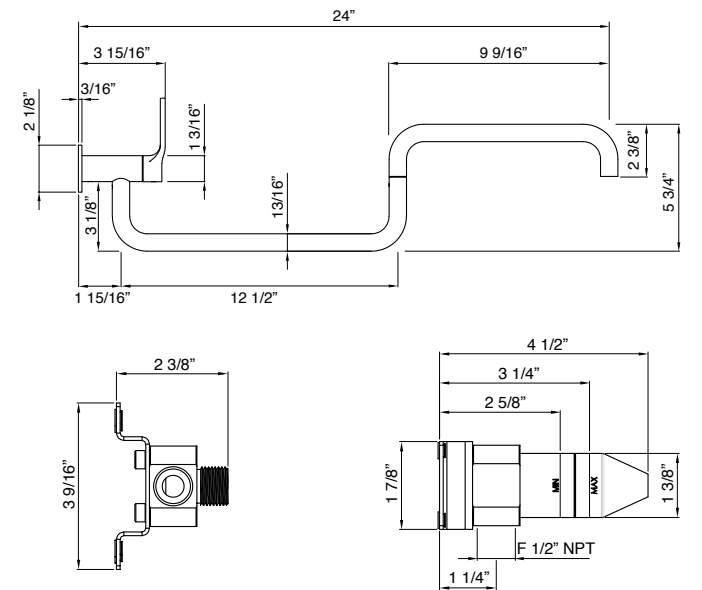

Tap Accessories

Ideal Soap Dispenser

ISD-1-PSS	ISD-1-MSS	ISD-1-GSS	ISD-1-BSS	ISD-1-YSS	ISD-1-RSS
Polished Stainless Steel	Matte Stainless Steel	PVD Gun Metal Gray™ Stainless Steel	PVD Satin Black Stainless Steel	PVD Brushed Gold Stainless Steel Limited Edition	PVD Polished Rose Gold Stainless Steel Limited Edition
MSRP \$695	UMRP \$556	MSRP \$895	UMRP \$716	MSRP \$995	UMRP \$796

Specifications

Heavy-duty pump for added reliability
5 1/2" reach
5 1/2" clearance
Easy refill from the top
12 fluid ounce capacity
Maximum counter thickness 1 9/16"
Install hole diameter 1" min to 1 3/8" max

Construction

Solid 316L machined stainless steel construction
Available in Polished, Matte, PVD Gun Metal Gray™, PVD Satin Black, PVD Brushed Gold, PVD Polished Rose Gold
Indoor & outdoor
Limited Lifetime Warranty
Made in Italy

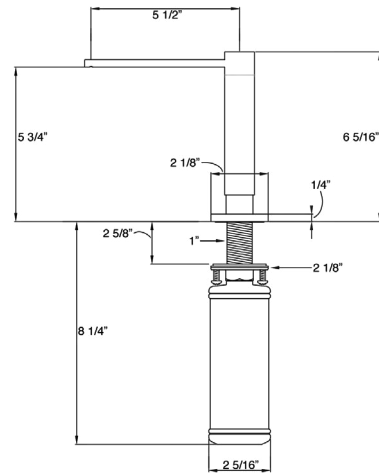

[Online Specification Page](#)

Ideal Deck Switch

IDS-1-PSS	IDS-1-MSS	IDS-1-GSS	IDS-1-BSS	IDS-1-YSS	IDS-1-RSS
Polished Stainless Steel	Matte Stainless Steel	PVD Gun Metal Gray™ Stainless Steel	PVD Satin Black Stainless Steel	PVD Brushed Gold Stainless Steel Limited Edition	PVD Polished Rose Gold Stainless Steel Limited Edition
MSRP \$495	UMRP \$396	MSRP \$595	UMRP \$476	MSRP \$650	UMRP \$520

Specifications

Air-activated button
Above the deck design for easy operation
Convenient alternative to a wall switch
Isolated from the electrical connections
Includes tubing and two outlet control box for disposal and a hot tank 120v 15amp 1hp
Maximum counter thickness 2 11/16"
Minimum install hole diameter 1 3/8"

Construction

Solid 316L machined stainless steel construction
Available in Polished, Matte, PVD Gun Metal Gray™, PVD Satin Black, PVD Brushed Gold, PVD Polished Rose Gold
Indoor & outdoor
Limited Lifetime Warranty
Made in Italy

Codes/Standards

UL
CSA Enclosure Type 2
ADA Compliant

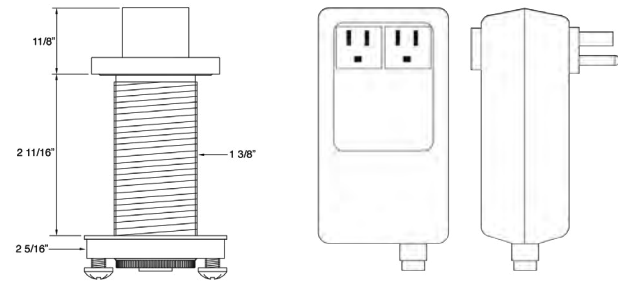

Appliance Control Box
4 3/8" H x 3" W x 1 3/4" D
120v 15amp 1Hp

[Online Specification Page](#)
[Order Form](#)

Tap Accessories

Ideal Tap Hole Cover

IHC-1-PSS	IHC-1-MSS	IHC-1-GSS	IHC-1-BSS	IHC-1-YSS	IHC-1-RSS
Polished Stainless Steel	Matte Stainless Steel	PVD Gun Metal Gray™ Stainless Steel	PVD Satin Black Stainless Steel	PVD Brushed Gold Stainless Steel Limited Edition	PVD Polished Rose Gold Stainless Steel Limited Edition
MSRP \$180	UMRP \$144	MSRP \$230	UMRP \$184	MSRP \$260	UMRP \$208

Specifications

Cover unused hole in sink or countertop
2 1/8" diameter covers standard size sink holes
Mounting hardware included for easy installation
Maximum counter thickness 2 1/4"

Construction

Solid 316L machined stainless steel construction
Available in Polished, Matte, PVD Gun Metal Gray™, PVD Satin Black, PVD Brushed Gold, PVD Polished Rose Gold
Indoor & outdoor
Limited Lifetime Warranty
Made in Italy

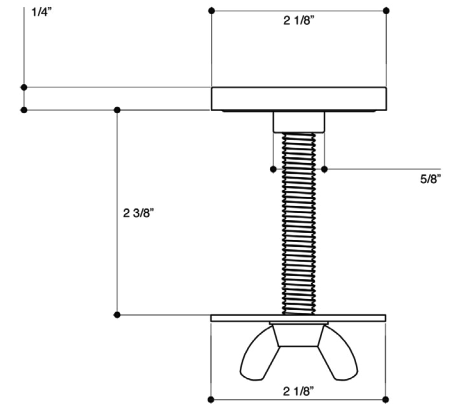

Specifications

Single port dishwasher air gap
Prevents dishwasher back-flow and dirt buildup
Included air gap rough
Maximum counter thickness 1 1/4"
Minimum install hole diameter 1 3/8"

Construction

Solid 316L machined stainless steel construction
Available in Polished, Matte, PVD Gun Metal Gray™, PVD Satin Black, PVD Brushed Gold, PVD Polished Rose Gold
Indoor & outdoor
Limited Lifetime Warranty
Made in Italy

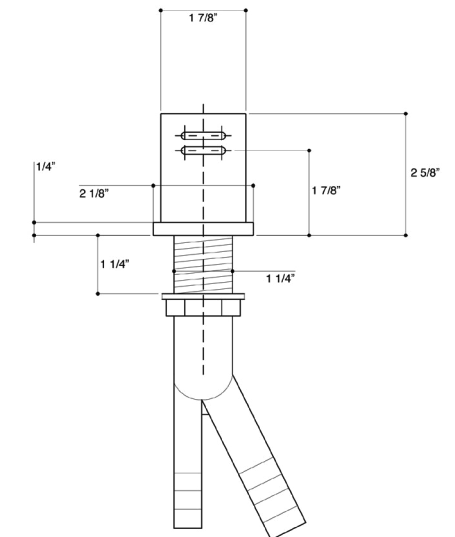

[Online Specification Page](#)
[Order Form](#)

Water Filtration System

IWF-79-HF

RFC-79-HF



Water Filtration System

MSRP	UMRP
\$320	\$256

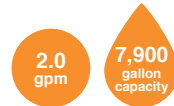

Features & Benefits

- High flow, high capacity, commercial quality water filtration system manufactured with a proprietary fibercarbon block
- Increases clarity of your drinking water
- Improves taste and reduces odors
- Certified for reduction of lead, chlorine, cysts, particulate class I and other contaminants
- Hybrid material with powder activated and fiber carbons
- Limited polymer binder used creating more active pores for higher absorption capacity
- Filtration removes particles from 0.5 micron in size
- Helps to protect Taps
- Retains vital minerals

Specifications

- Service flow rate 2.0 gpm
- Rated capacity 7,900 gallons
- Operating pressure 10 - 125 psi
- Operating temperature 35 - 100°F
- Overall dimensions 16 7/8" L x 4 1/8" D
- Quick twist-lock cartridge replacement
- Internal parts never exposed to human handling
- Filtration protects capital equipment from early breakdown
- Installs vertically (allow 2 1/2" clearance)
- Install in cold water supply only
- Use with Ideal Tap, BarTap- and Hot & Cold Tap

Substance	Average % Reduction
NSF/Ansi 42 - Aesthetic Effects	
Chlorine	>94.8%
Particulate, Class 1 particles 0.5 to < 1 m	>99.2%
NSF/Ansi 53 - Health Effects	
Cyst	>99.99%
Lead pH 6.5	>99.7%
Lead pH 8.5	>99.2%

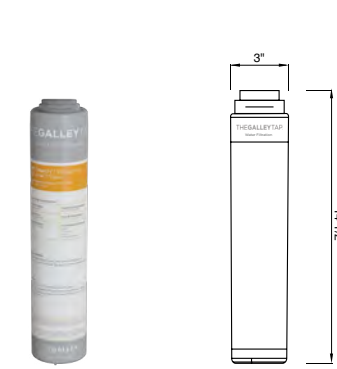

Replacement Cartridge

MSRP	UMRP
\$195	\$156

Included Contents

- 1 - Mounting Bracket
- 2 - System Head
- 3 - RFC-79-HF Filter
- 4 - 3/8" Double Elbow Tee
- 5 - John Guest Stem Push-fit Tee
- 6 - Mounting Screws
- 7 - 10' (120") x 3/8" Plastic Tubing
- 8 - Connector Push-fit Fitting 3/8" x 3/8"

Construction

Lasts up to 12 months dependent upon water quality and amount of water filtered

Codes/Standards

IWF-79-HF tested and certified by IAPMO R&T and IAPMO R&T Lab against CSA B483.1; against NSF/ANSI 42 for the reduction of chlorine, taste and odor and particulate class I; against NSF/ANSI 53 for the reduction of cyst and lead; against NSF/ANSI 372 for low lead compliance; as verified and substantiated by test data California compliant

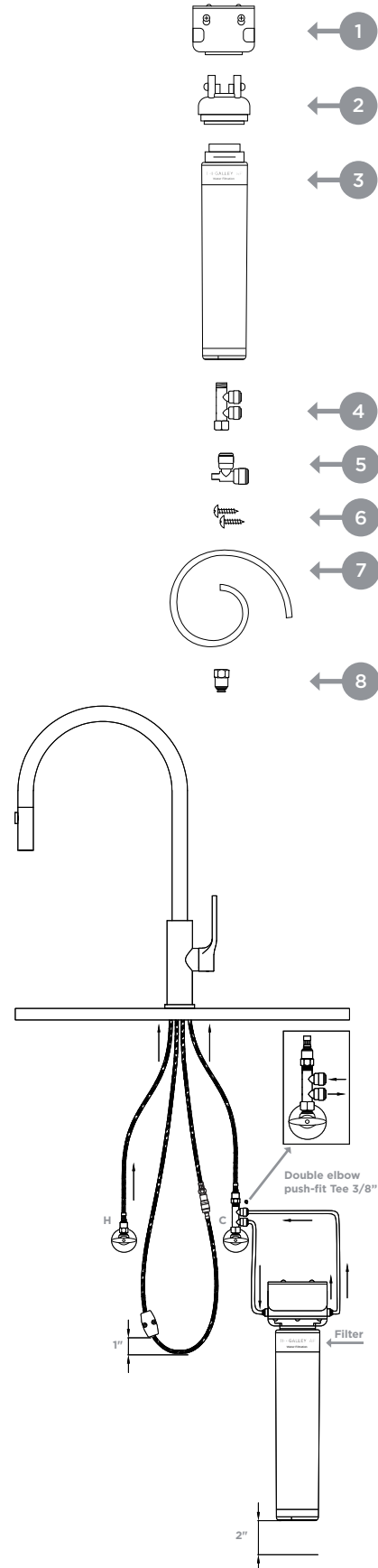

Ideal HydroStation™ with Graphite Wood Composite HydroPlate, Polished Stainless Steel Hot & Cold Tap

Use & Care

Stainless Steel Basin:

For everyday cleaning, we recommend cleaning the Galley basin with citrine® Stainless Steel Clean + Polish. This will restore the luster and keep the tiers sleek to allow the Tools to glide freely. On behalf of the cabinet(s) beneath the Galley Workstation, we highly recommend that you do not put ice directly in the Basin for an extended period of time. Doing so may result in condensation on the exterior of the Basin, therefore causing potential damage to the interior of the cabinets.

Graphite Wood Composite Tools:

The Graphite Tools can be cleaned in the dishwasher. For surface marks and light scratches use a Maroon Scotch-Brite® pad to lightly buff the surface. Using a microfiber towel, apply citrine® Wood Condition + Protect to the whole surface of the Tool. The area affected will be lighter in appearance with the original patina returning over time. Graphite Wood Composite is heat-resistant up to 350°F degrees. This product should only be used for preparing and serving food and never placed on or in any stove top, oven or grill.

Resin Tools:

Resin Tools can be cleaned in the dishwasher. Designer White Resin only: Spray bleach directly onto the boards to remove heavy stains. Let sit for 15-20 minutes or until stains dissolve. Wash thoroughly with soap and water. Resin Tools are heat-resistant to 180°F degrees.

Bamboo and Walnut Tools:

Once a month use the enclosed citrine® Wood Condition + Protect to condition the wood followed by citrine® Conditioning Balm to keep your Culinary Tools fresh and vibrant. This will help prevent splitting, and give the Bamboo and Walnut a nice, burnished look while maintaining the cleanliness of the cutting surface. For cleaning after use, hand wash with soap and water. Be sure to let wood dry completely. From time to time, as with any cutting board, you may notice vegetable stains settling into the board. This is normal and is not a health concern but can diminish the beauty of the wood. For stains, scrub coarse salt over the surface of the board with a sponge, then rinse and dry. On rare occasions, odors can also ingrain themselves in the wood. You can resolve this by rubbing a simple paste of baking soda and water over the board occasionally before rinsing and drying. If water is left pooled on the wood, it can cause discoloration. It is important to keep all areas dry after use. Proper care and cleaning of your Bamboo and Walnut Tools will ensure they last for years to come.

Wash Tools:

Copolyester Wash Bowl and Wash Caddy: Hand wash thoroughly with soap and water.

Salt Water Environments:

316L stainless is suitable for outdoor applications. The best way to protect stainless steel is to clean it frequently. If salt has time to establish itself on the surface, the effects of the chemical reaction will soon become visible. In salt air environments, we recommend cleaning the stainless steel surface at least every two weeks to keep your basin and Tap(s) in prime condition.

How To Restore the Original Luster of Your Galley:

For any questions please contact The Galley Headquarters at 800.375.4255 or customer@thegalley.com.

Use & Care

Chef's Block:

Your new Chef's Block has already been oiled with our citrine® Wood Condition + Protect, (food-safe, of course!), so you can start enjoying it right out of the box.

For the best long-term life: We recommend for the first couple of weeks that you oil your Chef's Block 2 or 3 more times. This will help build up its resistance to moisture and strengthen the wood for a long, healthy life. After that, a quick application every couple of months should suffice.

For simple cleaning: Hand wash using warm water with dish soap and a damp sponge or cloth. Allow your Chef's Block to dry thoroughly before the next use. The wood should never be fully submerged in water or placed in the dishwasher. If your Chef's Block ever smells less than fresh, you can simply rub a paste of baking soda and water over the board before rinsing and drying.

citrine®



CIT-09-SS-C

stainless steel clean + polish

Clean and restore the shine and luster of your Galley Workstation or any stainless steel surface with citrine stainless steel clean + polish. A gentle and food-safe liquid cleaner and polisher that removes debris and tarnish as well as protects the cleaned surface.

Ingredients

<5% Anionic Surfactants, <5% Non-Ionic Surfactants, <5% Phosphates. Contains Preservation Agents. Other Ingredients: Auxiliary Agents, Perfumes.

Codes/Standards

NSF



CIT-09-WD-C

wood condition + protect

Condition and protect your Galley Natural Golden Bamboo or American Black Walnut Culinary Tools or any wooden surface with citrine wood condition + protect. A unique blend of mineral oil, vitamin e, and beeswax moisturizes and preserves the natural beauty of the wood.

Ingredients

Mineral Oil, Vitamin E, Beeswax

Codes/Standards

NSF
Natural earth friendly



CIT-04-WD-B

wood finishing balm

Take the extra step to protect your wood products, use our citrine wood finishing balm after citrine wood condition + protect is applied. This natural, food-safe balm provides long-lasting protection and helps maximize sanitization.

Change the way your kitchen works



Ideal Workstation 5S, Ideal WashStation™ 3S with 12" DryDock., and Ideal BarStation, 2 with American Black Walnut Kits, PVD Brushed Gold Stainless Steel Taps, BarTap®, Hot & Cold Tap, Pot Filler Tap, Soap Dispensers, and Deck Switches

■ Prepare zone

Workstation, refrigeration drawers and waste bins centrally located in island

■ Entertain zone

Serve and entertain in the Galley Workstation and BarStation.

■ Cook zone

Cooktop located next to Workstation and Taps with ovens nearby

■ Clean zone

Cleaning station with dishwashers behind the primary WashStation™

Kitchen layout types

One wall

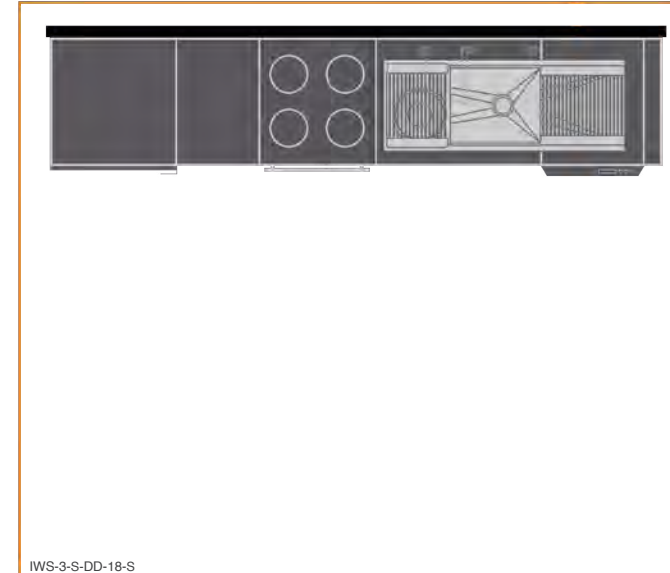

Galley

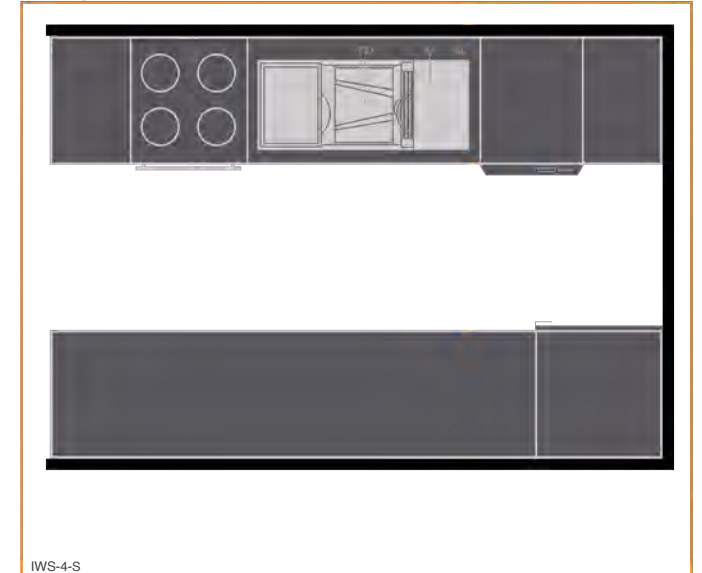

U-shape



L-shape

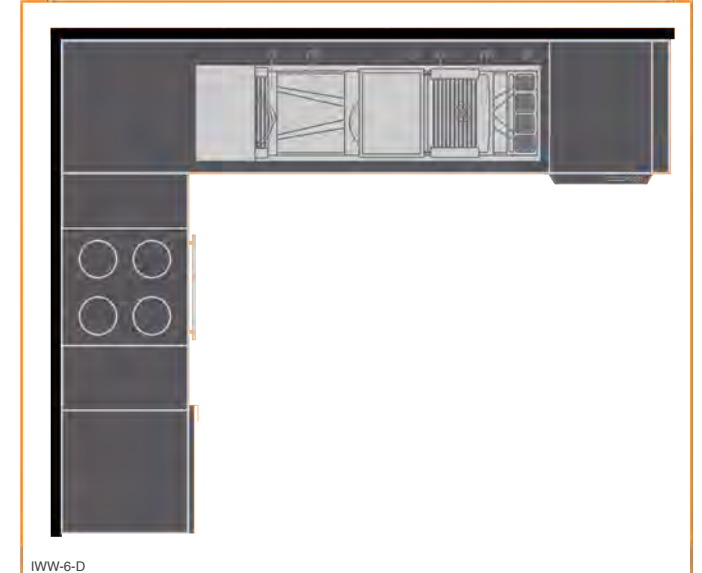

Island

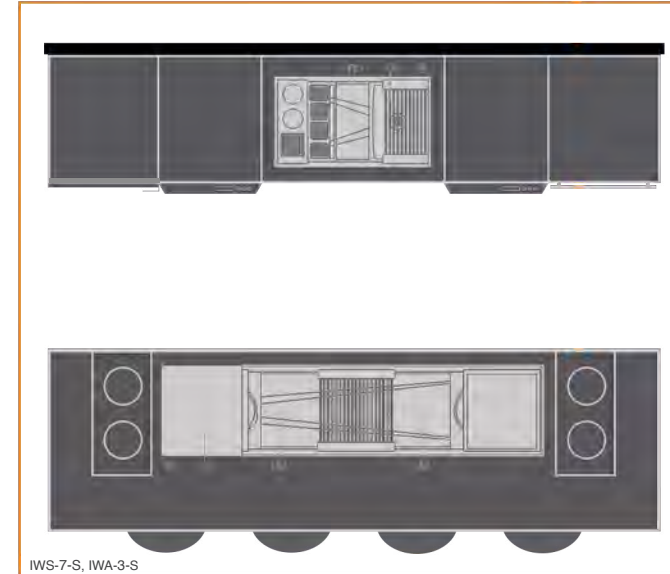

Peninsula



Kitchen Layout Types

Kitchen Layout Types

General Sales Terms & Conditions

Prices: Prices and terms are subject to change without notice.

MSRP: Manufacturer Suggested Retail Price.

UMRP: Unilateral Minimum Resale Price.

Delivery and Shipping Policy: Our products are shipped via LTL Freight or Ground directly from Tulsa, OK to the Designer, Dealer or Distributor showroom or warehouse. The lead time of our products is divided into two categories:

- **Standard Workstations:** Typically shipped 2-3 business days from the receipt of the purchase order.
- **Custom Workstations:** Typically shipped 5-6 weeks from the receipt of the client's approval of the custom specifications drawing.

Free Freight Allowance: Minimum order required is (5) Workstations or (5) Taps

Information on the Flat Rate Freight Program:

Product Category	Freight Fee
Workstations over 6' (includes Culinary Kit)	\$449*
Workstations over 3' and up to 6', and Corner Workstations (includes Culinary Kit)	\$249*
Workstations 3' and under (includes Culinary Kit)	\$99
HydroStation™ (includes HydroPlate)	\$55
Culinary and Speciality Kits (if ordered separately)	\$45
Upper Deck® sets, Bottom Grate sets	\$35
Taps (includes Filtration if ordered with Tap), Individual Culinary Tools, Individual Bottom Grates, Water Filtration (if ordered separately)	\$25
Tap Accessories, Strainer Baskets	\$15

***For Residential Delivery and for locations without a Loading Dock, add \$150, (lift gate is included).**

- **Freight Fees for each product included on the order will apply as they add weight, volume, and cost to the shipment.** For the freight fee on any item not shown here, please refer to the Product Index in the Price List.
- DryDock® — Add 1' to the size for each 12" DryDock or 1.5' for each 18" DryDock.
- Shipments that have already been sent but are requested by the Designer, Dealer, or Distributor to be rerouted while in transit will be subject to a rerouting charge.
- Expedited deliveries must be requested in advance. For these shipments, the Designer, Dealer or Distributor will be informed of the additional costs which will be included in their invoice. Drop-ship deliveries outside of Dealer or Distributors' immediate area require prior approval from a Galley representative.
- For shipments to Alaska and Hawaii, call for a freight quote.

General Sales Terms & Conditions

Freight Example (With Loading Dock):

Product	Quantity	Freight Fee
IWS-5-S	1	\$249
IWT-D-MSS	2	\$50
ISD-1-MSS	1	\$15
IDS-1-MSS	1	\$15
BG-5-S-2-SS	1	\$35
G-DRN-MSS	1	\$15
Freight Total	7	\$379

Payment Terms: Net 30

Make checks payable to:
The Galley, LLC
12626 South Memorial Drive
Bixby, OK 74008

Payments may be made by Credit Card and are subject to a 3.5% processing fee.

Return Policy: Non-damaged merchandise may be returned within 90 days of receipt *after* prior written authorization from The Galley.

All returns require a Returns Goods Authorization (RGA). A product in non-resalable condition will not be accepted. It is the Dealer/ Designer's responsibility to return the goods to The Galley, freight prepaid and with all relative paperwork included, (RGA, copy of the invoice and packing list). RGA number must be clearly noted on the outside of the parcel. Upon receipt and final inspection, The Galley will post a credit memo to the Dealer's account minus a 10% restocking fee. Please note that The Galley does not issue reimbursement checks for approved returns. Special or custom orders are not returnable.

Damage or Loss Policy: We make every effort to prevent damage during shipping. If your package is delivered with any visible damage, simply refuse the shipment. If, after the shipping company's driver has left, you realize that your package is damaged, immediately contact Galley Customer Service at (800) 375-4255. Please note that due to the time constraints to file a claim for shipping damage or loss, all shortages, missing or damaged items must be reported within 48 hours of receipt of the product.

Custom Orders: The Galley frequently receives custom/special orders. Many of the Custom Galley Workstation options are already listed in the Price Book under the "Custom Workstations" tab. If a customer would like to have an item produced other than what is shown, please contact us directly with a detailed description of what is desired and we will provide a price quote. If the customer would then like to proceed, we will send a drawing with exact dimensions for their approval. Once approval is received by us, a 50% deposit is required to begin the manufacturing process, which is approximately 5-6 weeks. Custom orders are non-returnable and non-cancellable. Custom Workstations may be subject to an additional freight charge based on the individual custom and special packaging and shipping that may be required. Any additional charge would be provided at the time the custom is initially quoted.

Sales Tax: Oklahoma and Illinois dealers are required to provide their resale permit and provide updated permits as they are renewed. If you are an Oklahoma or Illinois Dealer without a Resale Permit, we will bill, collect and remit the appropriate sales taxes on your order.

Dealers outside of Oklahoma and Illinois are responsible for collecting and remitting sales and use taxes to their municipalities.

General: If you have any questions regarding Galley policies, please contact us at (800) 375-4255.

The Galley Workstation Limited Lifetime Warranty

1. Galley Workstation Limited Lifetime Warranty – Seller provides a Limited Lifetime Warranty. Seller warrants its stainless steel sink, installed in a residential application, to be free from manufacturing defects in materials and workmanship under normal residential usage. This Limited Lifetime Warranty is subject to the warranty conditions and limitations as set forth below.

2. Warranty Conditions and Limitations – Seller's warranty is non-transferable and is strictly limited to products correctly installed using our installation instructions and used in a residential environment. This warranty is limited to defects or damages resulting from normal residential use and does not cover surface corrosion, (chemical or natural, including exposure to salt air, sea spray, acid rain, or environmental chemicals), scuffs or scratches, misuse, abnormal or abusive use, dents, deformations caused by the impact of any object, improper installation, care and/or maintenance, commercial use, environmental factors causing damage, shipping or freight damage, or common signs of normal wear and tear, (scratching, staining and alkaline etching of the finish over time due to use, cleaning practices or water or atmospheric conditions, are not manufacturing defects but are indicative of normal wear and tear however, these symptoms are easy to remedy). This limited warranty is null and void if the Product has been repaired, altered, or modified other than by Seller or under Seller's supervision. The Seller is not responsible for labor charges, installation or other incidental or consequential costs. In no event shall the liability of Seller exceed the purchase price of the product. If the product is installed outside of North America, Seller warrants product to be free from defects in material and workmanship for one (1) year from the date the product is installed, with all other terms of this warranty applying except duration. If the product has not been purchased from Seller or from an Authorized Dealer or Distributor of the Seller, this warranty is null and void.

3. Culinary Tools – The Culinary Tools are not covered under warranty. If a defect is found in normal residential use, Seller will, at its election, repair, replace or make appropriate adjustment. All items made of Natural Golden Bamboo or American Black Walnut should not have prolonged exposure to direct sunlight or be stored outdoors.

4. Care and Maintenance – For care and maintenance instructions of all Galley products, please refer to the Use and Care section on thegalley.com.

5. Warranty Claims – These warranties are in effect for Seller's Products purchased on January 1st, 2015 and thereafter. For warranty claims, please contact your Authorized Galley Dealer, or you may write to:

The Galley, LLC.
Attn: Warranty Claims
12626 South Memorial Drive
Bixby, OK 74008

Please include the original receipt with a description of the problem, model number, store, date of purchase, your name, address, and telephone number.

The Galley Tap Limited Lifetime Warranty

1. Galley Tap Limited Lifetime Mechanical Warranty – Seller provides a Limited Lifetime Mechanical Warranty. Seller warrants its products, installed in a residential application, to be free from manufacturing defects in materials and workmanship under normal usage for the useful life of the product. This Limited Lifetime Mechanical Warranty is subject to the warranty conditions and limitations as set forth below.

2. Galley Tap Limited Lifetime Finish Warranty – Seller provides a Limited Lifetime Finish Warranty. For the following Finishes: Polished Stainless Steel, Matte Stainless Steel, PVD Satin Black Stainless Steel, PVD Gun Metal Gray™ Stainless Steel, PVD Polished Rose Gold Stainless Steel and PVD Brushed Gold Stainless Steel, seller warrants its finishes, installed in a residential application, to be free from manufacturing defects in materials or workmanship for the useful life of the product. Please refer to the Seller's Care Instructions for the proper maintenance of Seller's finishes. This Limited Lifetime Finish Warranty is subject to the warranty conditions and limitations as set forth below.

3. Warranty Conditions and Limitations – Seller's Mechanical and Finish warranties are non-transferable and are strictly limited to products correctly installed using our installation instructions and used in a residential environment. Mechanical or finish problems which result from abuse, misuse, improper installation, improper maintenance, (including not properly winterizing the Tap in outdoor installations), improper cleaning, proximity to bodies of saltwater, or accidental damage such as scuffs and scratches are not covered by this warranty. Seller does not assume liability for labor charges, removal and re-installation expenses, freight or postage charges, or injuries resulting from a defective product. This warranty does not allow recovery of incidental or consequential damages such as loss of use, property damage, or any other consequential damage and Seller accepts no liability for such damage. Seller does not assume any responsibility other than to repair or replace the defective part(s) after Seller, upon its examination, has determined the product to be defective and the defective part(s) are covered by the Limited Lifetime Warranty expressed in this warranty. Whether to repair or replace the product shall be at the sole election of the Seller. In no event shall the liability of The Galley exceed the purchase price of the Tap. The use of Plumber's Putty will void this warranty. A non-corrosive epoxy silicone sealing compound may be used. Seller hereby disclaims all other warranties, expressed or implied, other than those set forth in this warranty. Some states do not allow the exclusion or limitation of incidental or consequential damages, so the above limitation or exclusion may not apply to you. This warranty gives you specific legal rights and you may also have other rights which vary from state to state.

4. Care and Maintenance – For care and maintenance instructions of all Galley products, please refer to the Use and Care section on thegalley.com.

5. Warranty Claims – These warranties are in effect for Seller's Products purchased on January 1st, 2017 and thereafter. For warranty claims, please contact your Authorized Galley Dealer, or you may write to:

The Galley, LLC.
Attn: Warranty Claims
12626 South Memorial Drive
Bixby, OK 74008

Please include the original receipt with a description of the problem, model number, store, date of purchase, your name, address and telephone number.

The Galley Hot & Cold Tap Limited Lifetime Warranty

1. Galley Tap Limited Lifetime Mechanical Warranty – Seller provides a Limited Lifetime Mechanical Warranty. Seller warrants its products, installed in a residential application, to be free from manufacturing defects in materials and workmanship under normal usage for the useful life of the product. This Limited Lifetime Mechanical Warranty is subject to the warranty conditions and limitations as set forth below.

2. Galley Tap Limited Lifetime Finish Warranty – Seller provides a Limited Lifetime Finish Warranty. For the following Finishes: Polished Stainless Steel, Matte Stainless Steel, PVD Satin Black Stainless Steel, PVD Gun Metal Gray™ Stainless Steel, PVD Polished Rose Gold Stainless Steel and PVD Brushed Gold Stainless Steel, seller warrants its finishes, installed in a residential application, to be free from manufacturing defects in materials or workmanship for the useful life of the product. Please refer to the Seller's Care Instructions for the proper maintenance of Seller's finishes. This Limited Lifetime Finish Warranty is subject to the warranty conditions and limitations as set forth below.

3. Galley Ideal Hot Water Tank Five (5) Year Limited Mechanical Warranty – Seller provides a Limited Mechanical Warranty. Seller warrants its Ideal Hot Water Tank, installed in a residential application using our installation instructions to be free from manufacturing defects in materials and workmanship under normal usage for a period of five (5) years from the date of purchase. Seller strongly recommends that a certified high flow water filtration unit be installed with the Hot Water Tank as unfiltered water with impurities can clog the dispenser and void the warranty. This Limited Mechanical Warranty is subject to the warranty conditions and limitations as set forth below.

4. Warranty Conditions and Limitations – Seller's Mechanical and Finish warranties are non-transferable and are strictly limited to products correctly installed using our installation instructions and used in a residential environment. Using a different Hot Tank with The Galley Hot and Cold Tap other than the Galley Ideal Hot Water Tank will void this warranty. Mechanical or finish problems which result from abuse, misuse, improper installation, improper maintenance, (including not properly winterizing the Tap in outdoor installations), improper cleaning, proximity to bodies of saltwater, or accidental damage such as scuffs and scratches are not covered by this warranty. Seller does not assume liability for labor charges, removal and reinstallation expenses, freight or postage charges, or injuries resulting from a defective product. This warranty does not allow recovery of incidental or consequential damages such as loss of use, property damage, or any other consequential damage and Seller accepts no liability for such damage. Seller does not assume any responsibility other than to repair or replace the defective part(s) after Seller, upon its examination, has determined the product to be defective and the defective part(s) are covered by the Limited Lifetime Warranty and Limited Warranty expressed in this warranty. Whether to repair or replace the product shall be at the sole election of the Seller. In no event shall the liability of The Galley exceed the purchase price of the Tap or Hot Water Tank. The use of Plumber's Putty will void this warranty. A non-corrosive epoxy silicone sealing compound may be used. Seller hereby disclaims all other warranties, expressed or implied, other than those set forth in this warranty. Some states do not allow the exclusion or limitation of incidental or consequential damages, so the above limitation or exclusion may not apply to you. This warranty gives you specific legal rights and you may also have other rights which vary from state to state.

5. Warranty Claims – These warranties are in effect for Seller's Products purchased on January 1st, 2019 and thereafter. For warranty claims, please contact your Authorized Galley Dealer, or you may write to:

The Galley, LLC.
Attn: Warranty Claims
12626 South Memorial Drive
Bixby, OK 74008

Please include the original receipt with a description of the problem, model number, store, date of purchase, your name, address and telephone number.

The Galley Water Filtration System Limited Lifetime Warranty

1. Galley Water Filtration One (1) Year Limited Mechanical Warranty – Seller provides a Limited Mechanical Warranty for the complete Filtration System (including the cartridge). Seller warrants its Filtration System, installed in a residential application using our installation instructions, to be free from manufacturing defects in materials and workmanship under normal usage for a period of one (1) year from the date of purchase. Defects must be reported to Seller within the warranty period. Seller strongly recommends that a new cartridge be installed every six (6) months for maximum results. Cartridge must be replaced every 12 months maximum. This Limited Mechanical Warranty is subject to the warranty conditions and limitations as set forth below.

2. Warranty Conditions and Limitations – Seller's Mechanical warranties are non-transferable and are strictly limited to products correctly installed using our installation instructions and used in a residential environment. Mechanical problems which result from abuse, misuse, improper installation, improper maintenance, (including not properly winterizing the Tap and Filtration System in outdoor installations), improper cleaning, proximity to bodies of saltwater, accidental damage such as scuffs and scratches, or noncompliance with applicable codes and ordinances are not covered by this warranty. Seller does not assume liability for labor charges, removal and reinstallation expenses, freight or postage charges, or injuries resulting from a defective product. This warranty does not allow recovery of incidental or consequential damages caused by accident, fire, flood, excessive head or cold, Acts of God, misuse, or misapplication that result in loss of use, property damage, or any other consequential damage and Seller accepts no liability for such damage. Seller does not assume any responsibility other than to repair or replace the defective part(s) after Seller, upon its examination, has determined the product to be defective and the defective part(s) are covered by the Limited Lifetime Warranty and Limited Warranty expressed in this warranty. The cost of installation and labor to install warranted parts, including trip charges, are not covered by this warranty unless Seller has approved in writing. Whether to repair or replace the product shall be at the sole election of the Seller. In no event shall the liability of The Galley exceed the purchase price of the Tap or Filtration System. Seller hereby disclaims all other warranties, expressed or implied, other than those set forth in this warranty. Some states do not allow the exclusion or limitation of incidental or consequential damages, so the above limitation or exclusion may not apply to you. This warranty gives you specific legal rights and you may also have other rights which vary from state to state.

3. Warranty Claims – For claims covered by the Limited Warranty of The Water Filtration System, the defective part or the product must be returned to us immediately after discovery of the material defect and not to exceed the warranty period set forth above. The part or product must be returned to the original point of shipment, freight prepaid, along with the Returns Good Authorization form. Seller is not responsible for any cost of shipping or transportation incurred in connection with the return of the part or product. Returning the part or product in a way that does not ensure integrity of the part or product during shipment may result in a voided warranty.

These warranties are in effect for Seller's Products purchased on January 1st, 2019 and thereafter. For warranty claims, please contact your Authorized Galley Dealer, or you may write to:

The Galley, LLC.
Attn: Warranty Claims
12626 South Memorial Drive
Bixby, OK 74008

Please include the original receipt with a description of the problem, model number, store, date of purchase, your name, address and telephone number.

Product Index

Sorted by product category

Single Bowl Workstations

Product code	Description	MSRP	UMRP	Freight
CKT-12-BA	Culinary Kit including Five Tools for IWS 2C, 30S, 3S, 4S in Natural Golden Bamboo	\$1,200	\$1,080	\$45
CKT-12-GR	Culinary Kit including Five Tools for IWS 2C, 30S, 3S, 4S in Exclusive Gray Resin	\$900	\$810	\$45
CKT-12-GT	Culinary Kit including Five Tools for IWS 2C, 30S, 3S, 4S in Graphite Wood Composite	\$1,200	\$1,080	\$45
CKT-12-WA	Culinary Kit including Five Tools for IWS 2C, 30S, 3S, 4S in American Black Walnut	\$1,600	\$1,440	\$45
CKT-12-WH	Culinary Kit including Five Tools for IWS 2C, 30S, 3S, 4S in Designer White Resin	\$900	\$810	\$45
CKT-17-BA	Culinary Kit including Eight Tools for IWS 5S, 6S, 7S in Natural Golden Bamboo	\$1,700	\$1,530	\$45
CKT-17-GR	Culinary Kit including Eight Tools for IWS 5S, 6S, 7S in Exclusive Gray Resin	\$1,300	\$1,170	\$45
CKT-17-GT	Culinary Kit including Eight Tools for IWS 5S, 6S, 7S in Graphite Wood Composite	\$1,700	\$1,530	\$45
CKT-17-WA	Culinary Kit including Eight Tools for IWS 5S, 6S, 7S in American Black Walnut	\$2,200	\$1,980	\$45
CKT-17-WH	Culinary Kit including Eight Tools for IWS 5S, 6S, 7S in Designer White Resin	\$1,300	\$1,170	\$45
IWS-2-C-BA	Ideal Workstation 2C with Five Tool Culinary Kit in Natural Golden Bamboo	\$3,295	\$2,966	\$99
IWS-2-C-GR	Ideal Workstation 2C with Five Tool Culinary Kit in Exclusive Gray Resin	\$2,995	\$2,696	\$99
IWS-2-C-GT	Ideal Workstation 2C with Five Tool Culinary Kit in Graphite Wood Composite	\$3,295	\$2,966	\$99
IWS-2-C-WA	Ideal Workstation 2C with Five Tool Culinary Kit in American Black Walnut	\$3,695	\$3,326	\$99
IWS-2-C-WH	Ideal Workstation 2C with Five Tool Culinary Kit in Designer White Resin	\$2,995	\$2,696	\$99
IWS-30-S-BA	Ideal Workstation 30S with Five Tool Culinary Kit in Natural Golden Bamboo	\$3,595	\$3,236	\$99
IWS-30-S-GR	Ideal Workstation 30S with Five Tool Culinary Kit in Exclusive Gray Resin	\$3,295	\$2,966	\$99
IWS-30-S-GT	Ideal Workstation 30S with Five Tool Culinary Kit in Graphite Wood Composite	\$3,595	\$3,236	\$99
IWS-30-S-WA	Ideal Workstation 30S with Five Tool Culinary Kit in American Black Walnut	\$3,995	\$3,596	\$99
IWS-30-S-WH	Ideal Workstation 30S with Five Tool Culinary Kit in Designer White Resin	\$3,295	\$2,966	\$99
IWS-3-S-BA	Ideal Workstation 3S with Five Tool Culinary Kit in Natural Golden Bamboo	\$3,895	\$3,506	\$99
IWS-3-S-GR	Ideal Workstation 3S with Five Tool Culinary Kit in Exclusive Gray Resin	\$3,595	\$3,236	\$99
IWS-3-S-GT	Ideal Workstation 3S with Five Tool Culinary Kit in Graphite Wood Composite	\$3,895	\$3,506	\$99
IWS-3-S-WA	Ideal Workstation 3S with Five Tool Culinary Kit in American Black Walnut	\$4,295	\$3,866	\$99
IWS-3-S-WH	Ideal Workstation 3S with Five Tool Culinary Kit in Designer White Resin	\$3,595	\$3,236	\$99
IWS-4-S-BA	Ideal Workstation 4S with Five Tool Culinary Kit in Natural Golden Bamboo	\$4,895	\$4,406	\$249*
IWS-4-S-GR	Ideal Workstation 4S with Five Tool Culinary Kit in Exclusive Gray Resin	\$4,595	\$4,136	\$249*
IWS-4-S-GT	Ideal Workstation 4S with Five Tool Culinary Kit in Graphite Wood Composite	\$4,895	\$4,406	\$249*
IWS-4-S-WA	Ideal Workstation 4S with Five Tool Culinary Kit in American Black Walnut	\$5,295	\$4,766	\$249*
IWS-4-S-WH	Ideal Workstation 4S with Five Tool Culinary Kit in Designer White Resin	\$4,595	\$4,136	\$249*
IWS-5-S-BA	Ideal Workstation 5S with Eight Tool Culinary Kit in Natural Golden Bamboo	\$5,995	\$5,396	\$249*
IWS-5-S-GR	Ideal Workstation 5S with Eight Tool Culinary Kit in Exclusive Gray Resin	\$5,595	\$5,036	\$249*
IWS-5-S-GT	Ideal Workstation 5S with Eight Tool Culinary Kit in Graphite Wood Composite	\$5,995	\$5,396	\$249*
IWS-5-S-WA	Ideal Workstation 5S with Eight Tool Culinary Kit in American Black Walnut	\$6,495	\$5,846	\$249*
IWS-5-S-WH	Ideal Workstation 5S with Eight Tool Culinary Kit in Designer White Resin	\$5,595	\$5,036	\$249*
IWS-6-S-BA	Ideal Workstation 6S with Eight Tool Culinary Kit in Natural Golden Bamboo	\$6,595	\$5,936	\$249*
IWS-6-S-GR	Ideal Workstation 6S with Eight Tool Culinary Kit in Exclusive Gray Resin	\$6,195	\$5,576	\$249*
IWS-6-S-GT	Ideal Workstation 6S with Eight Tool Culinary Kit in Graphite Wood Composite	\$6,595	\$5,936	\$249*
IWS-6-S-WA	Ideal Workstation 6S with Eight Tool Culinary Kit in American Black Walnut	\$7,095	\$6,386	\$249*
IWS-6-S-WH	Ideal Workstation 6S with Eight Tool Culinary Kit in Designer White Resin	\$6,195	\$5,576	\$249*
IWS-7-S-BA	Ideal Workstation 7S with Eight Tool Culinary Kit in Natural Golden Bamboo	\$7,195	\$6,476	\$449*
IWS-7-S-GR	Ideal Workstation 7S with Eight Tool Culinary Kit in Exclusive Gray Resin	\$6,795	\$6,116	\$449*
IWS-7-S-GT	Ideal Workstation 7S with Eight Tool Culinary Kit in Graphite Wood Composite	\$7,195	\$6,476	\$449*
IWS-7-S-WA	Ideal Workstation 7S with Eight Tool Culinary Kit in American Black Walnut	\$7,695	\$6,926	\$449*
IWS-7-S-WH	Ideal Workstation 7S with Eight Tool Culinary Kit in Designer White Resin	\$6,795	\$6,116	\$449*
KSO-2-C-SS	Basin Portion of IWS 2C in Angel Finish 316L Stainless Steel	\$2,095	\$1,886	\$54
KSO-30-S-SS	Basin Portion of IWS 30S in Angel Finish 316L Stainless Steel	\$2,395	\$2,156	\$54
KSO-3-S-SS	Basin Portion of IWS 3S in Angel Finish 316L Stainless Steel	\$2,695	\$2,426	\$54
KSO-4-S-SS	Basin Portion of IWS 4S in Angel Finish 316L Stainless Steel	\$3,695	\$3,326	\$204*
KSO-5-S-SS	Basin Portion of IWS 5S in Angel Finish 316L Stainless Steel	\$4,295	\$3,866	\$204*
KSO-6-S-SS	Basin Portion of IWS 6S in Angel Finish 316L Stainless Steel	\$4,895	\$4,406	\$204*
KSO-7-S-SS	Basin Portion of IWS 7S in Angel Finish 316L Stainless Steel	\$5,495	\$4,946	\$404*

Corner Workstations

Product code	Description	MSRP	UMRP	Freight
CKT-12-BA	Culinary Kit including Five Tools for IWS 3X4C, 4X3C, 4X4C in Natural Golden Bamboo	\$1,200	\$1,080	\$45
CKT-12-GR	Culinary Kit including Five Tools for IWS 3X4C, 4X3C, 4X4C in Exclusive Gray Resin	\$900	\$810	\$45
CKT-12-GT	Culinary Kit including Five Tools for IWS 3X4C, 4X3C, 4X4C in Graphite Wood Composite	\$1,200	\$1,080	\$45
CKT-12-WA	Culinary Kit including Five Tools for IWS 3X4C, 4X3C, 4X4C in American Black Walnut	\$1,600	\$1,440	\$45
CKT-12-WH	Culinary Kit including Five Tools for IWS 3X4C, 4X3C, 4X4C in Designer White Resin	\$900	\$810	\$45
IWS-3X4-C-BA	Ideal Corner Workstation 3X4C with Five Tool Culinary Kit in Natural Golden Bamboo	\$7,295	\$6,566	\$249*
IWS-3X4-C-GR	Ideal Corner Workstation 3X4C with Five Tool Culinary Kit in Exclusive Gray Resin	\$6,995	\$6,296	\$249*
IWS-3X4-C-GT	Ideal Corner Workstation 3X4C with Five Tool Culinary Kit in Graphite Wood Composite	\$7,295	\$6,566	\$249*
IWS-3X4-C-WA	Ideal Corner Workstation 3X4C with Five Tool Culinary Kit in American Black Walnut	\$7,695	\$6,926	\$249*
IWS-3X4-C-WH	Ideal Corner Workstation 3X4C with Five Tool Culinary Kit in Designer White Resin	\$6,995	\$6,296	\$249*
IWS-4X3-C-BA	Ideal Corner Workstation 4X3C with Five Tool Culinary Kit in Natural Golden Bamboo	\$7,295	\$6,566	\$249*
IWS-4X3-C-GR	Ideal Corner Workstation 4X3C with Five Tool Culinary Kit in Exclusive Gray Resin	\$6,995	\$6,296	\$249*
IWS-4X3-C-GT	Ideal Corner Workstation 4X3C with Five Tool Culinary Kit in Graphite Wood Composite	\$7,295	\$6,566	\$249*
IWS-4X3-C-WA	Ideal Corner Workstation 4X3C with Five Tool Culinary Kit in American Black Walnut	\$7,695	\$6,926	\$249*
IWS-4X3-C-WH	Ideal Corner Workstation 4X3C with Five Tool Culinary Kit in Designer White Resin	\$6,995	\$6,296	\$249*
IWS-4X4-C-BA	Ideal Corner Workstation 4X4C with Five Tool Culinary Kit in Natural Golden Bamboo	\$8,295	\$7,466	\$249*
IWS-4X4-C-GR	Ideal Corner Workstation 4X4C with Five Tool Culinary Kit in Exclusive Gray Resin	\$7,995	\$7,196	\$249*
IWS-4X4-C-GT	Ideal Corner Workstation 4X4C with Five Tool Culinary Kit in Graphite Wood Composite	\$8,295	\$7,466	\$249*
IWS-4X4-C-WA	Ideal Corner Workstation 4X4C with Five Tool Culinary Kit in American Black Walnut	\$8,695	\$7,826	\$249*
IWS-4X4-C-WH	Ideal Corner Workstation 4X4C with Five Tool Culinary Kit in Designer White Resin	\$7,995	\$7,196	\$249*

Product Index

Sorted by product category

Corner Workstations

Product code	Description	MSRP	UMRP	Freight
KSO-3X4-C-SS	Basin Portion of IWS 3X4C in Angel Finish 316L Stainless Steel	\$6,095	\$5,486	\$204*
KSO-4X3-C-SS	Basin Portion of IWS 4X3C in Angel Finish 316L Stainless Steel	\$6,095	\$5,486	\$204*
KSO-4X4-C-SS	Basin Portion of IWS 4X4C in Angel Finish 316L Stainless Steel	\$7,095	\$6,386	\$204*

WashStations™

Product code	Description	MSRP	UMRP	Freight
IWA-2-C-BA	Ideal WashStation™ 2C with Four Tool Wash Kit in Natural Golden Bamboo / Exclusive Gray Resin+	\$2,995	\$2,696	\$99
IWA-2-C-GR	Ideal WashStation™ 2C with Four Tool Wash Kit in Exclusive Gray Resin / Resin+	\$2,895	\$2,606	\$99
IWA-2-C-GT	Ideal WashStation™ 2C with Four Tool Wash Kit in Graphite Wood Composite / Graphite Resin+	\$2,995	\$2,696	\$99
IWA-2-C-WA	Ideal WashStation™ 2C with Four Tool Wash Kit in American Black Walnut / Graphite Resin+	\$3,095	\$2,786	\$99
IWA-2-C-WH	Ideal WashStation™ 2C with Four Tool Wash Kit in Designer White Resin / Resin+	\$2,895	\$2,606	\$99
IWA-30-S-BA	Ideal WashStation™ 30S with Four Tool Wash Kit in Natural Golden Bamboo / Exclusive Gray Resin+	\$3,295	\$2,966	\$99
IWA-30-S-GR	Ideal WashStation™ 30S with Four Tool Wash Kit in Exclusive Gray Resin / Resin+	\$3,195	\$2,876	\$99
IWA-30-S-GT	Ideal WashStation™ 30S with Four Tool Wash Kit in Graphite Wood Composite / Graphite Resin+	\$3,295	\$2,966	\$99
IWA-30-S-WA	Ideal WashStation™ 30S with Four Tool Wash Kit in American Black Walnut / Graphite Resin+	\$3,395	\$3,056	\$99
IWA-30-S-WH	Ideal WashStation™ 30S with Four Tool Wash Kit in Designer White Resin / Resin+	\$3,195	\$2,876	\$99
IWA-3-S-BA	Ideal WashStation™ 3S with Four Tool Wash Kit in Natural Golden Bamboo / Exclusive Gray Resin+	\$3,595	\$3,236	\$99
IWA-3-S-GR	Ideal WashStation™ 3S with Four Tool Wash Kit in Exclusive Gray Resin / Resin+	\$3,495	\$3,146	\$99
IWA-3-S-GT	Ideal WashStation™ 3S with Four Tool Wash Kit in Graphite Wood Composite / Graphite Resin+	\$3,595	\$3,236	\$99
IWA-3-S-WA	Ideal WashStation™ 3S with Four Tool Wash Kit in American Black Walnut / Graphite Resin+	\$3,695	\$3,326	\$99
IWA-3-S-WH	Ideal WashStation™ 3S with Four Tool Wash Kit in Designer White Resin / Resin+	\$3,495	\$3,146	\$99
IWA-4-S-BA	Ideal WashStation™ 4S with Four Tool Wash Kit in Natural Golden Bamboo / Exclusive Gray Resin+	\$4,595	\$4,136	\$249*
IWA-4-S-GR	Ideal WashStation™ 4S with Four Tool Wash Kit in Exclusive Gray Resin / Resin+	\$4,495	\$4,046	\$249*
IWA-4-S-GT	Ideal WashStation™ 4S with Four Tool Wash Kit in Graphite Wood Composite / Graphite Resin+	\$4,595	\$4,136	\$249*
IWA-4-S-WA	Ideal WashStation™ 4S with Four Tool Wash Kit in American Black Walnut / Graphite Resin+	\$4,695	\$4,226	\$249*
IWA-4-S-WH	Ideal WashStation™ 4S with Four Tool Wash Kit in Designer White Resin / Resin+	\$4,495	\$4,046	\$249*
IWA-4-D-BA	Ideal Double Bowl WashStation™ 4D with Four Tool Wash Kit in Natural Golden Bamboo / Exclusive Gray Resin+	\$5,995	\$5,396	\$249*
IWA-4-D-GR	Ideal Double Bowl WashStation™ 4D with Four Tool Wash Kit in Exclusive Gray Resin / Resin+	\$5,895	\$5,306	\$249*
IWA-4-D-GT	Ideal Double Bowl WashStation™ 4D with Four Tool Wash Kit in Graphite Wood Composite / Graphite Resin+	\$5,995	\$5,396	\$249*
IWA-4-D-WA	Ideal Double Bowl WashStation™ 4D with Four Tool Wash Kit in American Black Walnut / Graphite Resin+	\$6,095	\$5,486	\$249*
IWA-4-D-WH	Ideal Double Bowl WashStation™ 4D with Four Tool Wash Kit in Designer White Resin / Resin+	\$5,895	\$5,306	\$249*
KSO-2-C-SS	Basin Portion of IWA 2C in Angel Finish 316L Stainless Steel	\$2,095	\$1,886	\$54
KSO-30-S-SS	Basin Portion of IWA 30S in Angel Finish 316L Stainless Steel	\$2,395	\$2,156	\$54
KSO-3-S-SS	Basin Portion of IWA 3S in Angel Finish 316L Stainless Steel	\$2,695	\$2,426	\$54
KSO-4-S-SS	Basin Portion of IWA 4S in Angel Finish 316L Stainless Steel	\$3,695	\$3,326	\$204*
KSO-4-D-SS	Basin Portion of IWA 4D in Angel Finish 316L Stainless Steel	\$5,095	\$4,586	\$204*
WKT-4T-BA	Wash Kit including Four Tools for IWA 2C, 30S, 3S, 4S, 4D in Natural Golden Bamboo / Exclusive Gray Resin+	\$900	\$810	\$45
WKT-4T-GR	Wash Kit including Four Tools for IWA 2C, 30S, 3S, 4S, 4D in Exclusive Gray Resin / Resin+	\$800	\$720	\$45
WKT-4T-GT	Wash Kit including Four Tools for IWA 2C, 30S, 3S, 4S, 4D in Graphite Wood Composite / Graphite Resin+	\$900	\$810	\$45
WKT-4T-WA	Wash Kit including Four Tools for IWA 2C, 30S, 3S, 4S, 4D in American Black Walnut / Graphite Resin+	\$1,000	\$900	\$45
WKT-4T-WH	Wash Kit including Four Tools for IWA 2C, 30S, 3S, 4S, 4D in Designer White Resin / Resin+	\$800	\$720	\$45

Corner WashStations™

Product code	Description	MSRP	UMRP	Freight
IWA-3X4-C-BA	Ideal Corner WashStation™ 3X4C with Four Tool Wash Kit in Natural Golden Bamboo / Exclusive Gray Resin+	\$6,995	\$6,296	\$249*
IWA-3X4-C-GR	Ideal Corner WashStation™ 3X4C with Four Tool Wash Kit in Exclusive Gray Resin / Resin+	\$6,895	\$6,206	\$249*
IWA-3X4-C-GT	Ideal Corner WashStation™ 3X4C with Four Tool Wash Kit in Graphite Wood Composite / Graphite Resin+	\$6,995	\$6,296	\$249*
IWA-3X4-C-WA	Ideal Corner WashStation™ 3X4C with Four Tool Wash Kit in American Black Walnut / Graphite Resin+	\$7,095	\$6,386	\$249*
IWA-3X4-C-WH	Ideal Corner WashStation™ 3X4C with Four Tool Wash Kit in Designer White Resin / Resin+	\$6,895	\$6,206	\$249*
IWA-4X3-C-BA	Ideal Corner WashStation™ 4X3C with Four Tool Wash Kit in Natural Golden Bamboo / Exclusive Gray Resin+	\$6,995	\$6,296	\$249*
IWA-4X3-C-GR	Ideal Corner WashStation™ 4X3C with Four Tool Wash Kit in Exclusive Gray Resin / Resin+	\$6,895	\$6,206	\$249*
IWA-4X3-C-GT	Ideal Corner WashStation™ 4X3C with Four Tool Wash Kit in Graphite Wood Composite / Graphite Resin+	\$6,995	\$6,296	\$249*
IWA-4X3-C-WA	Ideal Corner WashStation™ 4X3C with Four Tool Wash Kit in American Black Walnut / Graphite Resin+	\$7,095	\$6,386	\$249*
IWA-4X3-C-WH	Ideal Corner WashStation™ 4X3C with Four Tool Wash Kit in Designer White Resin / Resin+	\$6,895	\$6,206	\$249*
IWA-4X4-C-BA	Ideal Corner WashStation™ 4X4C with Four Tool Wash Kit in Natural Golden Bamboo / Exclusive Gray Resin+	\$7,995	\$7,196	\$249*
IWA-4X4-C-GR	Ideal Corner WashStation™ 4X4C with Four Tool Wash Kit in Exclusive Gray Resin / Resin+	\$7,895	\$7,106	\$249*
IWA-4X4-C-GT	Ideal Corner WashStation™ 4X4C with Four Tool Wash Kit in Graphite Wood Composite / Graphite Resin+	\$7,995	\$7,196	\$249*
IWA-4X4-C-WA	Ideal Corner WashStation™ 4X4C with Four Tool Wash Kit in American Black Walnut / Graphite Resin+	\$8,095	\$7,286	\$249*
IWA-4X4-C-WH	Ideal Corner WashStation™ 4X4C with Four Tool Wash Kit in Designer White Resin / Resin+	\$7,895	\$7,106	\$249*
KSO-3X4-C-SS	Basin Portion of IWA 3X4C in Angel Finish 316L Stainless Steel	\$6,095	\$5,486	\$204*
KSO-4X3-C-SS	Basin Portion of IWA 4X3C in Angel Finish 316L Stainless Steel	\$6,095	\$5,486	\$204*
KSO-4X4-C-SS	Basin Portion of IWA 4X4C in Angel Finish 316L Stainless Steel	\$7,095	\$6,386	\$204*
WKT-4T-BA	Wash Kit including Four Tools for IWA 3X4C, 4X3C, 4X4C in Natural Golden Bamboo / Exclusive Gray Resin+	\$900	\$810	\$45
WKT-4T-GR	Wash Kit including Four Tools for IWA 3X4C, 4X3C, 4X4C in Exclusive Gray Resin / Resin+	\$800	\$720	\$45
WKT-4T-GT	Wash Kit including Four Tools for IWA 3X4C, 4X3C, 4X4C in Graphite Wood Composite / Graphite Resin+	\$900	\$810	\$45
WKT-4T-WA	Wash Kit including Four Tools for IWA 3X4C, 4X3C, 4X4C in American Black Walnut / Graphite Resin+	\$1,000	\$900	\$45
WKT-4T-WH	Wash Kit including Four Tools for IWA 3X4C, 4X3C, 4X4C in Designer White Resin / Resin+	\$800	\$720	\$45

Work&WashStations™

Product code	Description	MSRP	UMRP	Freight
CKT-12-BA	Culinary Kit including Five Tools for IWW 4D, 5D, 6D in Natural Golden Bamboo	\$1,200	\$1,080	\$45
CKT-12-GR	Culinary Kit including Five Tools for IWW 4D, 5D, 6D in Exclusive Gray Resin	\$900	\$810	\$45
CKT-12-GT	Culinary Kit including Five Tools for IWW 4D, 5D, 6D in Graphite Wood Composite	\$1,200	\$1,080	\$45
CKT-12-WA	Culinary Kit including Five Tools for IWW 4D, 5D, 6D in American Black Walnut	\$1,600	\$1,440	\$45
CKT-12-WH	Culinary Kit including Five Tools for IWW 4D, 5D, 6D in Designer White Resin	\$900	\$810	\$45

Product Index

Sorted by product category

Work&WashStations™

Product code	Description	MSRP	UMRP	Freight
CKT-17-BA	Culinary Kit including Eight Tools for IWW 7D in Natural Golden Bamboo	\$1,700	\$1,530	\$45
CKT-17-GR	Culinary Kit including Eight Tools for IWW 7D in Exclusive Gray Resin	\$1,300	\$1,170	\$45
CKT-17-GT	Culinary Kit including Eight Tools for IWW 7D in Graphite Wood Composite	\$1,700	\$1,530	\$45
CKT-17-WA	Culinary Kit including Eight Tools for IWW 7D in American Black Walnut	\$2,200	\$1,980	\$45
CKT-17-WH	Culinary Kit including Eight Tools for IWW 7D in Designer White Resin	\$1,300	\$1,170	\$45
IWW-4-D-BA	Ideal Work&WashStation™ 4D with Five Tool Culinary Kit and Four Tool Wash Kit in Natural Golden Bamboo / Exclusive Gray Resin+	\$7,195	\$6,476	\$249*
IWW-4-D-GR	Ideal Work&WashStation™ 4D with Five Tool Culinary Kit and Four Tool Wash Kit in Exclusive Gray Resin / Resin+	\$6,795	\$6,116	\$249*
IWW-4-D-GT	Ideal Work&WashStation™ 4D with Five Tool Culinary Kit and Four Tool Wash Kit in Graphite Wood Composite / Graphite Resin+	\$7,195	\$6,476	\$249*
IWW-4-D-WA	Ideal Work&WashStation™ 4D with Five Tool Culinary Kit and Four Tool Wash Kit in American Black Walnut / Graphite Resin+	\$7,695	\$6,926	\$249*
IWW-4-D-WH	Ideal Work&WashStation™ 4D with Five Tool Culinary Kit and Four Tool Wash Kit in Designer White Resin / Resin+	\$6,795	\$6,116	\$249*
IWW-5-D-BA	Ideal Work&WashStation™ 5D with Five Tool Culinary Kit and Four Tool Wash Kit in Natural Golden Bamboo / Exclusive Gray Resin+	\$8,195	\$7,376	\$249*
IWW-5-D-GR	Ideal Work&WashStation™ 5D with Five Tool Culinary Kit and Four Tool Wash Kit in Exclusive Gray Resin / Resin+	\$7,795	\$7,016	\$249*
IWW-5-D-GT	Ideal Work&WashStation™ 5D with Five Tool Culinary Kit and Four Tool Wash Kit in Graphite Wood Composite / Graphite Resin+	\$8,195	\$7,376	\$249*
IWW-5-D-WA	Ideal Work&WashStation™ 5D with Five Tool Culinary Kit and Four Tool Wash Kit in American Black Walnut / Graphite Resin+	\$8,695	\$7,826	\$249*
IWW-5-D-WH	Ideal Work&WashStation™ 5D with Five Tool Culinary Kit and Four Tool Wash Kit in Designer White Resin / Resin+	\$7,795	\$7,016	\$249*
IWW-6-D-BA	Ideal Work&WashStation™ 6D with Five Tool Culinary Kit and Four Tool Wash Kit in Natural Golden Bamboo / Exclusive Gray Resin+	\$8,795	\$7,916	\$249*
IWW-6-D-GR	Ideal Work&WashStation™ 6D with Five Tool Culinary Kit and Four Tool Wash Kit in Exclusive Gray Resin / Resin+	\$8,395	\$7,556	\$249*
IWW-6-D-GT	Ideal Work&WashStation™ 6D with Five Tool Culinary Kit and Four Tool Wash Kit in Graphite Wood Composite / Graphite Resin+	\$8,795	\$7,916	\$249*
IWW-6-D-WA	Ideal Work&WashStation™ 6D with Five Tool Culinary Kit and Four Tool Wash Kit in American Black Walnut / Graphite Resin+	\$9,295	\$8,366	\$249*
IWW-6-D-WH	Ideal Work&WashStation™ 6D with Five Tool Culinary Kit and Four Tool Wash Kit in Designer White Resin / Resin+	\$8,395	\$7,556	\$249*
IWW-7-D-BA	Ideal Work&WashStation™ 7D with Eight Tool Culinary Kit and Four Tool Wash Kit in Natural Golden Bamboo / Exclusive Gray Resin+	\$10,195	\$9,176	\$449*
IWW-7-D-GR	Ideal Work&WashStation™ 7D with Eight Tool Culinary Kit and Four Tool Wash Kit in Exclusive Gray Resin / Resin+	\$9,695	\$8,726	\$449*
IWW-7-D-GT	Ideal Work&WashStation™ 7D with Eight Tool Culinary Kit and Four Tool Wash Kit in Graphite Wood Composite / Graphite Resin+	\$10,195	\$9,176	\$449*
IWW-7-D-WA	Ideal Work&WashStation™ 7D with Eight Tool Culinary Kit and Four Tool Wash Kit in American Black Walnut / Graphite Resin+	\$10,795	\$9,716	\$449*
IWW-7-D-WH	Ideal Work&WashStation™ 7D with Eight Tool Culinary Kit and Four Tool Wash Kit in Designer White Resin / Resin+	\$9,695	\$8,726	\$449*
KSO-4-D-SS	Basin Portion of IWW 4D in Angel Finish 316L Stainless Steel	\$5,095	\$4,586	\$204*
KSO-5-D-SS	Basin Portion of IWW 5D in Angel Finish 316L Stainless Steel	\$6,095	\$5,486	\$204*
KSO-6-D-SS	Basin Portion of IWW 6D in Angel Finish 316L Stainless Steel	\$6,695	\$6,026	\$204*
KSO-7-D-SS	Basin Portion of IWW 7D in Angel Finish 316L Stainless Steel	\$7,595	\$6,836	\$404*
WKT-4T-BA	Wash Kit including Four Tools for IWW 4D, 5D, 6D, 7D in Natural Golden Bamboo / Exclusive Gray Resin+	\$900	\$810	\$45
WKT-4T-GR	Wash Kit including Four Tools for IWW 4D, 5D, 6D, 7D in Exclusive Gray Resin / Resin+	\$800	\$720	\$45
WKT-4T-GT	Wash Kit including Four Tools for IWW 4D, 5D, 6D, 7D in Graphite Wood Composite / Graphite Resin+	\$900	\$810	\$45
WKT-4T-WA	Wash Kit including Four Tools for IWW 4D, 5D, 6D, 7D in American Black Walnut / Graphite Resin+	\$1,000	\$900	\$45
WKT-4T-WH	Wash Kit including Four Tools for IWW 4D, 5D, 6D, 7D in Designer White Resin / Resin+	\$800	\$720	\$45

BarStations.

Product code	Description	MSRP	UMRP	Freight
BKT-3T-BA	Bar Kit including Three Tools for IBS 18C, 2C in Natural Golden Bamboo	\$700	\$630	\$45
BKT-3T-GR	Bar Kit including Three Tools for IBS 18C, 2C in Exclusive Gray Resin	\$500	\$450	\$45
BKT-3T-GT	Bar Kit including Three Tools for IBS 18C, 2C in Graphite Wood Composite	\$700	\$630	\$45
BKT-3T-WA	Bar Kit including Three Tools for IBS 18C, 2C in American Black Walnut	\$900	\$810	\$45
BKT-3T-WH	Bar Kit including Three Tools for IBS 18C, 2C in Designer White Resin	\$500	\$450	\$45
IBS-18-C-BA	Ideal BarStation. 18 with Three Tool Bar Kit in Natural Golden Bamboo	\$2,495	\$2,246	\$99
IBS-18-C-GR	Ideal BarStation. 18 with Three Tool Bar Kit in Exclusive Gray Resin	\$2,295	\$2,066	\$99
IBS-18-C-GT	Ideal BarStation. 18 with Three Tool Bar Kit in Graphite Wood Composite	\$2,495	\$2,246	\$99
IBS-18-C-WA	Ideal BarStation. 18 with Three Tool Bar Kit in American Black Walnut	\$2,695	\$2,426	\$99
IBS-18-C-WH	Ideal BarStation. 18 with Three Tool Bar Kit in Designer White Resin	\$2,295	\$2,066	\$99
IBS-2-C-BA	Ideal BarStation. 2 with Three Tool Bar Kit in Natural Golden Bamboo	\$2,795	\$2,516	\$99
IBS-2-C-GR	Ideal BarStation. 2 with Three Tool Bar Kit in Exclusive Gray Resin	\$2,595	\$2,336	\$99
IBS-2-C-GT	Ideal BarStation. 2 with Three Tool Bar Kit in Graphite Wood Composite	\$2,795	\$2,516	\$99
IBS-2-C-WA	Ideal BarStation. 2 with Three Tool Bar Kit in American Black Walnut	\$2,995	\$2,696	\$99
IBS-2-C-WH	Ideal BarStation. 2 with Three Tool Bar Kit in Designer White Resin	\$2,595	\$2,336	\$99
KSO-18-C-SS	Basin Portion of IBS 18C in Angel Finish 316L Stainless Steel	\$1,795	\$1,616	\$54
KSO-2-C-SS	Basin Portion of IBS 2C in Angel Finish 316L Stainless Steel	\$2,095	\$1,886	\$54

HydroStation™

Product code	Description	MSRP	UMRP	Freight
HP-7X7-BA	HydroPlate 7" x 7" with Wedge Wire Grate 4" x 4" in Natural Golden Bamboo	\$250	\$225	\$25
HP-7X7-GR	HydroPlate 7" x 7" with Wedge Wire Grate 4" x 4" in Exclusive Gray Resin	\$225	\$203	\$25
HP-7X7-GT	HydroPlate 7" x 7" with Wedge Wire Grate 4" x 4" in Graphite Wood Composite	\$250	\$225	\$25
HP-7X7-WA	HydroPlate 7" x 7" with Wedge Wire Grate 4" x 4" in American Black Walnut	\$275	\$248	\$25
HP-7X7-WH	HydroPlate 7" x 7" with Wedge Wire Grate 4" x 4" in Designer White Resin	\$225	\$203	\$25
HHSO-1-V-SS	Basin Portion of IHS in Angel Finish 316L Stainless Steel	\$1,000	\$900	\$30
IHS-1-V-BA	Ideal HydroStation™ with HydroPlate in Natural Golden Bamboo	\$1,250	\$1,125	\$55
IHS-1-V-GR	Ideal HydroStation™ with HydroPlate in Exclusive Gray Resin	\$1,225	\$1,103	\$55
IHS-1-V-GT	Ideal HydroStation™ with HydroPlate in Graphite Wood Composite	\$1,250	\$1,125	\$55
IHS-1-V-WA	Ideal HydroStation™ with HydroPlate in American Black Walnut	\$1,275	\$1,148	\$55
IHS-1-V-WH	Ideal HydroStation™ with HydroPlate in Designer White Resin	\$1,225	\$1,103	\$55

DryDock.

Product code	Description	MSRP	UMRP	Freight
CKT-12-BA	Culinary Kit including Five Tools for IWS + DryDock in Natural Golden Bamboo	\$1,200	\$1,080	\$45
CKT-12-GR	Culinary Kit including Five Tools for IWS + DryDock in Exclusive Gray Resin	\$900	\$810	\$45
CKT-12-GT	Culinary Kit including Five Tools for IWS + DryDock in Graphite Wood Composite	\$1,200	\$1,080	\$45
CKT-12-WA	Culinary Kit including Five Tools for IWS + DryDock in American Black Walnut	\$1,600	\$1,440	\$45

Product Index

Sorted by product category

DryDock.

Product code	Description	MSRP	UMRP	Freight
CKT-12-WH	Culinary Kit including Five Tools for IWS + DryDock in Designer White Resin	\$900	\$810	\$45
DD-12-S-BA	DryDock. 12" Drain Side with Lower Tier Drying Rack in Natural Golden Bamboo	\$1,775	\$1,598	N/A
DD-12-S-GR	DryDock. 12" Drain Side with Lower Tier Drying Rack in Exclusive Gray Resin	\$1,725	\$1,553	N/A
DD-12-S-GT	DryDock. 12" Drain Side with Lower Tier Drying Rack in Graphite Wood Composite	\$1,775	\$1,598	N/A
DD-12-S-WA	DryDock. 12" Drain Side with Lower Tier Drying Rack in American Black Walnut	\$1,825	\$1,643	N/A
DD-12-S-WH	DryDock. 12" Drain Side with Lower Tier Drying Rack in Designer White Resin	\$1,725	\$1,553	N/A
DD-12-N-BA	DryDock. 12" Non-drain Side with Lower Tier Drying Rack in Natural Golden Bamboo	\$1,775	\$1,598	N/A
DD-12-N-GR	DryDock. 12" Non-drain Side with Lower Tier Drying Rack in Exclusive Gray Resin	\$1,725	\$1,553	N/A
DD-12-N-GT	DryDock. 12" Non-drain Side with Lower Tier Drying Rack in Graphite Wood Composite	\$1,775	\$1,598	N/A
DD-12-N-WA	DryDock. 12" Non-drain Side with Lower Tier Drying Rack in American Black Walnut	\$1,825	\$1,643	N/A
DD-12-N-WH	DryDock. 12" Non-drain Side with Lower Tier Drying Rack in Designer White Resin	\$1,725	\$1,553	N/A
DD-12-C-BA	DryDock. 12" Center Drain with Lower Tier Drying Rack in Natural Golden Bamboo	\$1,775	\$1,598	N/A
DD-12-C-GR	DryDock. 12" Center Drain with Lower Tier Drying Rack in Exclusive Gray Resin	\$1,725	\$1,553	N/A
DD-12-C-GT	DryDock. 12" Center Drain with Lower Tier Drying Rack in Graphite Wood Composite	\$1,775	\$1,598	N/A
DD-12-C-WA	DryDock. 12" Center Drain with Lower Tier Drying Rack in American Black Walnut	\$1,825	\$1,643	N/A
DD-12-C-WH	DryDock. 12" Center Drain with Lower Tier Drying Rack in Designer White Resin	\$1,725	\$1,553	N/A
DD-18-S-BA	DryDock. 18" Drain Side with Dual Tier Drying Rack in Natural Golden Bamboo	\$2,125	\$1,913	N/A
DD-18-S-GR	DryDock. 18" Drain Side with Dual Tier Drying Rack in Exclusive Gray Resin	\$2,050	\$1,845	N/A
DD-18-S-GT	DryDock. 18" Drain Side with Dual Tier Drying Rack in Graphite Wood Composite	\$2,125	\$1,913	N/A
DD-18-S-WA	DryDock. 18" Drain Side with Dual Tier Drying Rack in American Black Walnut	\$2,175	\$1,958	N/A
DD-18-S-WH	DryDock. 18" Drain Side with Dual Tier Drying Rack in Designer White Resin	\$2,050	\$1,845	N/A
DD-18-N-BA	DryDock. 18" Non-drain Side with Dual Tier Drying Rack in Natural Golden Bamboo	\$2,125	\$1,913	N/A
DD-18-N-GR	DryDock. 18" Non-drain Side with Dual Tier Drying Rack in Exclusive Gray Resin	\$2,050	\$1,845	N/A
DD-18-N-GT	DryDock. 18" Non-drain Side with Dual Tier Drying Rack in Graphite Wood Composite	\$2,125	\$1,913	N/A
DD-18-N-WA	DryDock. 18" Non-drain Side with Dual Tier Drying Rack in American Black Walnut	\$2,175	\$1,958	N/A
DD-18-N-WH	DryDock. 18" Non-drain Side with Dual Tier Drying Rack in Designer White Resin	\$2,050	\$1,845	N/A
DD-18-C-BA	DryDock. 18" Center Drain with Dual Tier Drying Rack in Natural Golden Bamboo	\$2,125	\$1,913	N/A
DD-18-C-GR	DryDock. 18" Center Drain with Dual Tier Drying Rack in Exclusive Gray Resin	\$2,050	\$1,845	N/A
DD-18-C-GT	DryDock. 18" Center Drain with Dual Tier Drying Rack in Graphite Wood Composite	\$2,125	\$1,913	N/A
DD-18-C-WA	DryDock. 18" Center Drain with Dual Tier Drying Rack in American Black Walnut	\$2,175	\$1,958	N/A
DD-18-C-WH	DryDock. 18" Center Drain with Dual Tier Drying Rack in Designer White Resin	\$2,050	\$1,845	N/A
DR-12-L-BA	Lower Tier Drying Rack for DryDock. 12-1/4" x 17" in Natural Golden Bamboo	\$275	\$248	\$25
DR-12-L-GR	Lower Tier Drying Rack for DryDock. 12-1/4" x 17" in Exclusive Gray Resin	\$225	\$203	\$25
DR-12-L-GT	Lower Tier Drying Rack for DryDock. 12-1/4" x 17" in Graphite Wood Composite	\$275	\$248	\$25
DR-12-L-WA	Lower Tier Drying Rack for DryDock. 12-1/4" x 17" in American Black Walnut	\$325	\$293	\$25
DR-12-L-WH	Lower Tier Drying Rack for DryDock. 12-1/4" x 17" in Designer White Resin	\$225	\$203	\$25
DR-18-D-BA	Dual Tier Drying Rack for DryDock. 18" x 17" in Natural Golden Bamboo	\$325	\$293	\$25
DR-18-D-GR	Dual Tier Drying Rack for DryDock. 18" x 17" in Exclusive Gray Resin	\$250	\$225	\$25
DR-18-D-GT	Dual Tier Drying Rack for DryDock. 18" x 17" in Graphite Wood Composite	\$325	\$293	\$25
DR-18-D-WA	Dual Tier Drying Rack for DryDock. 18" x 17" in American Black Walnut	\$375	\$338	\$25
DR-18-D-WH	Dual Tier Drying Rack for DryDock. 18" x 17" in Designer White Resin	\$250	\$225	\$25
DS-12-S-SS	DryDock. 12" only - Drain Side	\$1,500	\$1,350	N/A
DS-18-S-SS	DryDock. 18" only - Drain Side	\$1,800	\$1,620	N/A
DS-12-N-SS	DryDock. 12" only - Non-drain Side	\$1,500	\$1,350	N/A
DS-18-N-SS	DryDock. 18" only - Non-drain Side	\$1,800	\$1,620	N/A
DS-12-C-SS	DryDock. 12" only - Center Drain	\$1,500	\$1,350	N/A
DS-18-C-SS	DryDock. 18" only - Center Drain	\$1,800	\$1,620	N/A
IWA-30-S-DD-12-S-BA	Ideal WashStation™ 30S + 12" DryDock. Drain Side, Four Tool Wash Kit, One DryDock Tool in Natural Golden Bamboo / Exclusive Gray Resin+	\$5,070	\$4,563	\$249*
IWA-30-S-DD-12-S-GR	Ideal WashStation™ 30S + 12" DryDock. Drain Side, Four Tool Wash Kit, One DryDock Tool in Exclusive Gray Resin / Resin+	\$4,920	\$4,428	\$249*
IWA-30-S-DD-12-S-GT	Ideal WashStation™ 30S + 12" DryDock. Drain Side, Four Tool Wash Kit, One DryDock Tool in Graphite Wood Composite / Graphite Resin+	\$5,070	\$4,563	\$249*
IWA-30-S-DD-12-S-WA	Ideal WashStation™ 30S + 12" DryDock. Drain Side, Four Tool Wash Kit, One DryDock Tool in American Black Walnut / Graphite Resin+	\$5,220	\$4,698	\$249*
IWA-30-S-DD-12-S-WH	Ideal WashStation™ 30S + 12" DryDock. Drain Side, Four Tool Wash Kit, One DryDock Tool in Designer White Resin / Resin+	\$4,920	\$4,428	\$249*
IWA-30-S-DD-18-S-BA	Ideal WashStation™ 30S + 18" DryDock. Drain Side, Four Tool Wash Kit, One DryDock Tool in Natural Golden Bamboo / Exclusive Gray Resin+	\$5,420	\$4,878	\$249*
IWA-30-S-DD-18-S-GR	Ideal WashStation™ 30S + 18" DryDock. Drain Side, Four Tool Wash Kit, One DryDock Tool in Exclusive Gray Resin / Resin+	\$5,245	\$4,721	\$249*
IWA-30-S-DD-18-S-GT	Ideal WashStation™ 30S + 18" DryDock. Drain Side, Four Tool Wash Kit, One DryDock Tool in Graphite Wood Composite / Graphite Resin+	\$5,420	\$4,878	\$249*
IWA-30-S-DD-18-S-WA	Ideal WashStation™ 30S + 18" DryDock. Drain Side, Four Tool Wash Kit, One DryDock Tool in American Black Walnut / Graphite Resin+	\$5,570	\$5,013	\$249*
IWA-30-S-DD-18-S-WH	Ideal WashStation™ 30S + 18" DryDock. Drain Side, Four Tool Wash Kit, One DryDock Tool in Designer White Resin / Resin+	\$5,245	\$4,721	\$249*
IWA-3-S-DD-12-S-BA	Ideal WashStation™ 3S + 12" DryDock. Drain Side, Four Tool Wash Kit, One DryDock Tool in Natural Golden Bamboo / Exclusive Gray Resin+	\$5,370	\$4,833	\$249*
IWA-3-S-DD-12-S-GR	Ideal WashStation™ 3S + 12" DryDock. Drain Side, Four Tool Wash Kit, One DryDock Tool in Exclusive Gray Resin / Resin+	\$5,220	\$4,698	\$249*
IWA-3-S-DD-12-S-GT	Ideal WashStation™ 3S + 12" DryDock. Drain Side, Four Tool Wash Kit, One DryDock Tool in Graphite Wood Composite / Graphite Resin+	\$5,370	\$4,833	\$249*
IWA-3-S-DD-12-S-WA	Ideal WashStation™ 3S + 12" DryDock. Drain Side, Four Tool Wash Kit, One DryDock Tool in American Black Walnut / Graphite Resin+	\$5,520	\$4,968	\$249*
IWA-3-S-DD-12-S-WH	Ideal WashStation™ 3S + 12" DryDock. Drain Side, Four Tool Wash Kit, One DryDock Tool in Designer White Resin / Resin+	\$5,220	\$4,698	\$249*
IWA-3-S-DD-18-S-BA	Ideal WashStation™ 3S + 18" DryDock. Drain Side, Four Tool Wash Kit, One DryDock Tool in Natural Golden Bamboo / Exclusive Gray Resin+	\$5,720	\$5,148	\$249*
IWA-3-S-DD-18-S-GR	Ideal WashStation™ 3S + 18" DryDock. Drain Side, Four Tool Wash Kit, One DryDock Tool in Exclusive Gray Resin / Resin+	\$5,545	\$4,991	\$249*
IWA-3-S-DD-18-S-GT	Ideal WashStation™ 3S + 18" DryDock. Drain Side, Four Tool Wash Kit, One DryDock Tool in Graphite Wood Composite / Graphite Resin+	\$5,720	\$5,148	\$249*
IWA-3-S-DD-18-S-WA	Ideal WashStation™ 3S + 18" DryDock. Drain Side, Four Tool Wash Kit, One DryDock Tool in American Black Walnut / Graphite Resin+	\$5,870	\$5,283	\$249*
IWA-3-S-DD-18-S-WH	Ideal WashStation™ 3S + 18" DryDock. Drain Side, Four Tool Wash Kit, One DryDock Tool in Designer White Resin / Resin+	\$5,545	\$4,991	\$249*
IWA-4-S-DD-12-S-BA	Ideal WashStation™ 4S + 12" DryDock. Drain Side, Four Tool Wash Kit, One DryDock Tool in Natural Golden Bamboo / Exclusive Gray Resin+	\$6,370	\$5,733	\$249*
IWA-4-S-DD-12-S-GR	Ideal WashStation™ 4S + 12" DryDock. Drain Side, Four Tool Wash Kit, One DryDock Tool in Exclusive Gray Resin / Resin+	\$6,220	\$5,598	\$249*
IWA-4-S-DD-12-S-GT	Ideal WashStation™ 4S + 12" DryDock. Drain Side, Four Tool Wash Kit, One DryDock Tool in Graphite Wood Composite / Graphite Resin+	\$6,370	\$5,733	\$249*
IWA-4-S-DD-12-S-WA	Ideal WashStation™ 4S + 12" DryDock. Drain Side, Four Tool Wash Kit, One DryDock Tool in American Black Walnut / Graphite Resin+	\$6,520	\$5,868	\$249*
IWA-4-S-DD-12-S-WH	Ideal WashStation™ 4S + 12" DryDock. Drain Side, Four Tool Wash Kit, One DryDock Tool in Designer White Resin / Resin+	\$6,220	\$5,598	\$249*
IWA-4-S-DD-18-S-BA	Ideal WashStation™ 4S + 18" DryDock. Drain Side, Four Tool Wash Kit, One DryDock Tool in Natural Golden Bamboo / Exclusive Gray Resin+	\$6,720	\$6,048	\$249*
IWA-4-S-DD-18-S-GR	Ideal WashStation™ 4S + 18" DryDock. Drain Side, Four Tool Wash Kit, One DryDock Tool in Exclusive Gray Resin / Resin+	\$6,545	\$5,891	\$249*
IWA-4-S-DD-18-S-GT	Ideal WashStation™ 4S + 18" DryDock. Drain Side, Four Tool Wash Kit, One DryDock Tool in Graphite Wood Composite / Graphite Resin+	\$6,720	\$6,048	\$249*

Product Index

Sorted by product category

DryDock.

Product code	Description	MSRP	UMRP	Freight
IWA-4-S-DD-18-S-WA	Ideal WashStation™ 4S + 18" DryDock. Drain Side, Four Tool Wash Kit, One DryDock Tool in American Black Walnut / Graphite Resin+	\$6,870	\$6,183	\$249*
IWA-4-S-DD-18-S-WH	Ideal WashStation™ 4S + 18" DryDock. Drain Side, Four Tool Wash Kit, One DryDock Tool in Designer White Resin / Resin+	\$6,545	\$5,891	\$249*
IWS-30-S-DD-12-S-BA	Ideal Workstation 30S + 12" DryDock. Drain Side, Five Tool Culinary Kit, One DryDock Tool in Natural Golden Bamboo	\$5,370	\$4,833	\$249*
IWS-30-S-DD-12-S-GR	Ideal Workstation 30S + 12" DryDock. Drain Side, Five Tool Culinary Kit, One DryDock Tool in Exclusive Gray Resin	\$5,020	\$4,518	\$249*
IWS-30-S-DD-12-S-GT	Ideal Workstation 30S + 12" DryDock. Drain Side, Five Tool Culinary Kit, One DryDock Tool in Graphite Wood Composite	\$5,370	\$4,833	\$249*
IWS-30-S-DD-12-S-WA	Ideal Workstation 30S + 12" DryDock. Drain Side, Five Tool Culinary Kit, One DryDock Tool in American Black Walnut	\$5,820	\$5,238	\$249*
IWS-30-S-DD-12-S-WH	Ideal Workstation 30S + 12" DryDock. Drain Side, Five Tool Culinary Kit, One DryDock Tool in Designer White Resin	\$5,020	\$4,518	\$249*
IWS-30-S-DD-18-S-BA	Ideal Workstation 30S + 18" DryDock. Drain Side, Five Tool Culinary Kit, One DryDock Tool in Natural Golden Bamboo	\$5,720	\$5,148	\$249*
IWS-30-S-DD-18-S-GR	Ideal Workstation 30S + 18" DryDock. Drain Side, Five Tool Culinary Kit, One DryDock Tool in Exclusive Gray Resin	\$5,345	\$4,811	\$249*
IWS-30-S-DD-18-S-GT	Ideal Workstation 30S + 18" DryDock. Drain Side, Five Tool Culinary Kit, One DryDock Tool in Graphite Wood Composite	\$5,720	\$5,148	\$249*
IWS-30-S-DD-18-S-WA	Ideal Workstation 30S + 18" DryDock. Drain Side, Five Tool Culinary Kit, One DryDock Tool in American Black Walnut	\$6,170	\$5,553	\$249*
IWS-30-S-DD-18-S-WH	Ideal Workstation 30S + 18" DryDock. Drain Side, Five Tool Culinary Kit, One DryDock Tool in Designer White Resin	\$5,345	\$4,811	\$249*
IWS-3-S-DD-12-S-BA	Ideal Workstation 3S + 12" DryDock. Drain Side, Five Tool Culinary Kit, One DryDock Tool in Natural Golden Bamboo	\$5,670	\$5,103	\$249*
IWS-3-S-DD-12-S-GR	Ideal Workstation 3S + 12" DryDock. Drain Side, Five Tool Culinary Kit, One DryDock Tool in Exclusive Gray Resin	\$5,320	\$4,788	\$249*
IWS-3-S-DD-12-S-GT	Ideal Workstation 3S + 12" DryDock. Drain Side, Five Tool Culinary Kit, One DryDock Tool in Graphite Wood Composite	\$5,670	\$5,103	\$249*
IWS-3-S-DD-12-S-WA	Ideal Workstation 3S + 12" DryDock. Drain Side, Five Tool Culinary Kit, One DryDock Tool in American Black Walnut	\$6,120	\$5,508	\$249*
IWS-3-S-DD-12-S-WH	Ideal Workstation 3S + 12" DryDock. Drain Side, Five Tool Culinary Kit, One DryDock Tool in Designer White Resin	\$5,320	\$4,788	\$249*
IWS-3-S-DD-18-S-BA	Ideal Workstation 3S + 18" DryDock. Drain Side, Five Tool Culinary Kit, One DryDock Tool in Natural Golden Bamboo	\$6,020	\$5,418	\$249*
IWS-3-S-DD-18-S-GR	Ideal Workstation 3S + 18" DryDock. Drain Side, Five Tool Culinary Kit, One DryDock Tool in Exclusive Gray Resin	\$5,645	\$5,081	\$249*
IWS-3-S-DD-18-S-GT	Ideal Workstation 3S + 18" DryDock. Drain Side, Five Tool Culinary Kit, One DryDock Tool in Graphite Wood Composite	\$6,020	\$5,418	\$249*
IWS-3-S-DD-18-S-WA	Ideal Workstation 3S + 18" DryDock. Drain Side, Five Tool Culinary Kit, One DryDock Tool in American Black Walnut	\$6,470	\$5,823	\$249*
IWS-3-S-DD-18-S-WH	Ideal Workstation 3S + 18" DryDock. Drain Side, Five Tool Culinary Kit, One DryDock Tool in Designer White Resin	\$5,645	\$5,081	\$249*
IWS-4-S-DD-12-S-BA	Ideal Workstation 4S + 12" DryDock. Drain Side, Five Tool Culinary Kit, One DryDock Tool in Natural Golden Bamboo	\$6,670	\$6,003	\$249*
IWS-4-S-DD-12-S-GR	Ideal Workstation 4S + 12" DryDock. Drain Side, Five Tool Culinary Kit, One DryDock Tool in Exclusive Gray Resin	\$6,320	\$5,688	\$249*
IWS-4-S-DD-12-S-GT	Ideal Workstation 4S + 12" DryDock. Drain Side, Five Tool Culinary Kit, One DryDock Tool in Graphite Wood Composite	\$6,670	\$6,003	\$249*
IWS-4-S-DD-12-S-WA	Ideal Workstation 4S + 12" DryDock. Drain Side, Five Tool Culinary Kit, One DryDock Tool in American Black Walnut	\$7,120	\$6,408	\$249*
IWS-4-S-DD-12-S-WH	Ideal Workstation 4S + 12" DryDock. Drain Side, Five Tool Culinary Kit, One DryDock Tool in Designer White Resin	\$6,320	\$5,688	\$249*
IWS-4-S-DD-18-S-BA	Ideal Workstation 4S + 18" DryDock. Drain Side, Five Tool Culinary Kit, One DryDock Tool in Natural Golden Bamboo	\$7,020	\$6,318	\$249*
IWS-4-S-DD-18-S-GR	Ideal Workstation 4S + 18" DryDock. Drain Side, Five Tool Culinary Kit, One DryDock Tool in Exclusive Gray Resin	\$6,645	\$5,981	\$249*
IWS-4-S-DD-18-S-GT	Ideal Workstation 4S + 18" DryDock. Drain Side, Five Tool Culinary Kit, One DryDock Tool in Graphite Wood Composite	\$7,020	\$6,318	\$249*
IWS-4-S-DD-18-S-WA	Ideal Workstation 4S + 18" DryDock. Drain Side, Five Tool Culinary Kit, One DryDock Tool in American Black Walnut	\$7,470	\$6,723	\$249*
IWS-4-S-DD-18-S-WH	Ideal Workstation 4S + 18" DryDock. Drain Side, Five Tool Culinary Kit, One DryDock Tool in Designer White Resin	\$6,645	\$5,981	\$249*
KSO-30-S-DS-12-S-SS	Basin Portion of IWS 30S + DD12, IWA 30S + DD12 in Angel Finish 316L Stainless Steel	\$3,895	\$3,506	\$204*
KSO-30-S-DS-18-S-SS	Basin Portion of IWS 30S + DD18, IWA 30S + DD18 in Angel Finish 316L Stainless Steel	\$4,195	\$3,776	\$204*
KSO-3-S-DS-12-S-SS	Basin Portion of IWS 3S + DD12, IWA 3S + DD12 in Angel Finish 316L Stainless Steel	\$4,195	\$3,776	\$204*
KSO-3-S-DS-18-S-SS	Basin Portion of IWS 3S + DD18, IWA 3S + DD18 in Angel Finish 316L Stainless Steel	\$4,495	\$4,046	\$204*
KSO-4-S-DS-12-S-SS	Basin Portion of IWS 4S + DD12, IWA 4S + DD12 in Angel Finish 316L Stainless Steel	\$5,195	\$4,676	\$204*
KSO-4-S-DS-18-S-SS	Basin Portion of IWS 4S + DD18, IWA 4S + DD18 in Angel Finish 316L Stainless Steel	\$5,495	\$4,946	\$204*
WKT-4T-BA	Wash Kit including Four Tools for IWA + DryDock. in Natural Golden Bamboo / Exclusive Gray Resin+	\$900	\$810	\$45
WKT-4T-GR	Wash Kit including Four Tools for IWA + DryDock. in Exclusive Gray Resin / Resin+	\$800	\$720	\$45
WKT-4T-GT	Wash Kit including Four Tools for IWA + DryDock. in Graphite Wood Composite / Graphite Resin+	\$900	\$810	\$45
WKT-4T-WA	Wash Kit including Four Tools for IWA + DryDock. in American Black Walnut / Graphite Resin+	\$1,000	\$900	\$45
WKT-4T-WH	Wash Kit including Four Tools for IWA + DryDock. in Designer White Resin / Resin+	\$800	\$720	\$45

ThinTop™

Product code	Description	MSRP	UMRP	Freight
BKT-3T-BA	Bar Kit including Three Tools for IBS 18C TT in Natural Golden Bamboo	\$700	\$630	\$45
BKT-3T-GR	Bar Kit including Three Tools for IBS 18C TT in Exclusive Gray Resin	\$500	\$450	\$45
BKT-3T-GT	Bar Kit including Three Tools for IBS 18C TT in Graphite Wood Composite	\$700	\$630	\$45
BKT-3T-WA	Bar Kit including Three Tools for IBS 18C TT in American Black Walnut	\$900	\$810	\$45
BKT-3T-WH	Bar Kit including Three Tools for IBS 18C TT in Designer White Resin	\$500	\$450	\$45
CKT-12-BA	Culinary Kit including Five Tools for IWS 3S TT, 3S + DD12 TT, 4S TT in Natural Golden Bamboo	\$1,200	\$1,080	\$45
CKT-12-GR	Culinary Kit including Five Tools for IWS 3S TT, 3S + DD12 TT, 4S TT in Exclusive Gray Resin	\$900	\$810	\$45
CKT-12-GT	Culinary Kit including Five Tools for IWS 3S TT, 3S + DD12 TT, 4S TT in Graphite Wood Composite	\$1,200	\$1,080	\$45
CKT-12-WA	Culinary Kit including Five Tools for IWS 3S TT, 3S + DD12 TT, 4S TT in American Black Walnut	\$1,600	\$1,440	\$45
CKT-12-WH	Culinary Kit including Five Tools for IWS 3S TT, 3S + DD12 TT, 4S TT in Designer White Resin	\$900	\$810	\$45
CKT-17-BA	Culinary Kit including Eight Tools for IWS 5S in Natural Golden Bamboo	\$1,700	\$1,530	\$45
CKT-17-GR	Culinary Kit including Eight Tools for IWS 5S in Exclusive Gray Resin	\$1,300	\$1,170	\$45
CKT-17-GT	Culinary Kit including Eight Tools for IWS 5S in Graphite Wood Composite	\$1,700	\$1,530	\$45
CKT-17-WA	Culinary Kit including Eight Tools for IWS 5S in American Black Walnut	\$2,200	\$1,980	\$45
CKT-17-WH	Culinary Kit including Eight Tools for IWS 5S in Designer White Resin	\$1,300	\$1,170	\$45
HP-7X7-BA	HydroPlate 7" x 7" with Wedge Wire Grate 4" x 4" for IHS TT in Natural Golden Bamboo	\$250	\$225	\$25
HP-7X7-GR	HydroPlate 7" x 7" with Wedge Wire Grate 4" x 4" for IHS TT in Exclusive Gray Resin	\$225	\$203	\$25
HP-7X7-GT	HydroPlate 7" x 7" with Wedge Wire Grate 4" x 4" for IHS TT in Graphite Wood Composite	\$250	\$225	\$25
HP-7X7-WA	HydroPlate 7" x 7" with Wedge Wire Grate 4" x 4" for IHS TT in American Black Walnut	\$275	\$248	\$25
HP-7X7-WH	HydroPlate 7" x 7" with Wedge Wire Grate 4" x 4" for IHS TT in Designer White Resin	\$225	\$203	\$25
HSO-1-V-TT-SS	Basin Portion of IHS TT in Angel Finish 316L Stainless Steel	\$1,250	\$1,125	\$30
IHS-1-V-TT-BA	Ideal ThinTop™ HydroStation™ with HydroPlate in Natural Golden Bamboo	\$1,500	\$1,350	\$55
IHS-1-V-TT-GR	Ideal ThinTop™ HydroStation™ with HydroPlate in Exclusive Gray Resin	\$1,475	\$1,328	\$55
IHS-1-V-TT-GT	Ideal ThinTop™ HydroStation™ with HydroPlate in Graphite Wood Composite	\$1,500	\$1,350	\$55
IHS-1-V-TT-WA	Ideal ThinTop™ HydroStation™ with HydroPlate in American Black Walnut	\$1,525	\$1,373	\$55
IHS-1-V-TT-WH	Ideal ThinTop™ HydroStation™ with HydroPlate in Designer White Resin	\$1,475	\$1,328	\$55
IBS-18-C-TT-BA	Ideal ThinTop™ BarStation. 18 with Three Tool Bar Kit in Natural Golden Bamboo	\$2,995	\$2,696	\$99
IBS-18-C-TT-GR	Ideal ThinTop™ BarStation. 18 with Three Tool Bar Kit in Exclusive Gray Resin	\$2,795	\$2,516	\$99
IBS-18-C-TT-GT	Ideal ThinTop™ BarStation. 18 with Three Tool Bar Kit in Graphite Wood Composite	\$2,995	\$2,696	\$99

Product Index

Sorted by product category

ThinTop™

Product code	Description	MSRP	UMRP	Freight
IBS-18-C-TT-WA	Ideal ThinTop™ BarStation. 18 with Three Tool Bar Kit in American Black Walnut	\$3,195	\$2,876	\$99
IBS-18-C-TT-WH	Ideal ThinTop™ BarStation. 18 with Three Tool Bar Kit in Designer White Resin	\$2,795	\$2,516	\$99
IWA-3-S-DD-12-S-TT-BA	Ideal ThinTop™ WashStation™ 3S + 12" DryDock. Drain Side, Four Tool Wash Kit, One DryDock Tool in Natural Golden Bamboo / Gray Resin+	\$5,870	\$5,283	\$249*
IWA-3-S-DD-12-S-TT-GR	Ideal ThinTop™ WashStation™ 3S + 12" DryDock. Drain Side, Four Tool Wash Kit, One DryDock Tool in Exclusive Gray Resin / Resin+	\$5,720	\$5,148	\$249*
IWA-3-S-DD-12-S-TT-GT	Ideal ThinTop™ WashStation™ 3S + 12" DryDock. Drain Side, Four Tool Wash Kit, One DryDock Tool in Graphite Wood Composite / Resin+	\$5,870	\$5,283	\$249*
IWA-3-S-DD-12-S-TT-WA	Ideal ThinTop™ WashStation™ 3S + 12" DryDock. Drain Side, Four Tool Wash Kit, One DryDock Tool in American Black Walnut / Graphite Resin+	\$6,020	\$5,418	\$249*
IWA-3-S-DD-12-S-TT-WH	Ideal ThinTop™ WashStation™ 3S + 12" DryDock. Drain Side, Four Tool Wash Kit, One DryDock Tool in Designer White Resin / Resin+	\$5,720	\$5,148	\$249*
IWA-3-S-TT-BA	Ideal ThinTop™ WashStation™ 3S with Four Tool Wash Kit in Natural Golden Bamboo / Exclusive Gray Resin+	\$4,095	\$3,686	\$99
IWA-3-S-TT-GR	Ideal ThinTop™ WashStation™ 3S with Four Tool Wash Kit in Exclusive Gray Resin / Resin+	\$3,995	\$3,596	\$99
IWA-3-S-TT-GT	Ideal ThinTop™ WashStation™ 3S with Four Tool Wash Kit in Graphite Wood Composite / Graphite Resin+	\$4,095	\$3,686	\$99
IWA-3-S-TT-WA	Ideal ThinTop™ WashStation™ 3S with Four Tool Wash Kit in American Black Walnut / Graphite Resin+	\$4,195	\$3,776	\$99
IWA-3-S-TT-WH	Ideal ThinTop™ WashStation™ 3S with Four Tool Wash Kit in Designer White Resin / Resin+	\$3,995	\$3,596	\$99
IWA-4-S-TT-BA	Ideal ThinTop™ WashStation™ 4S with Four Tool Wash Kit in Natural Golden Bamboo / Exclusive Gray Resin+	\$5,095	\$4,586	\$249*
IWA-4-S-TT-GR	Ideal ThinTop™ WashStation™ 4S with Four Tool Wash Kit in Exclusive Gray Resin / Resin+	\$4,995	\$4,496	\$249*
IWA-4-S-TT-GT	Ideal ThinTop™ WashStation™ 4S with Four Tool Wash Kit in Graphite Wood Composite / Graphite Resin+	\$5,095	\$4,586	\$249*
IWA-4-S-TT-WA	Ideal ThinTop™ WashStation™ 4S with Four Tool Wash Kit in American Black Walnut / Graphite Resin+	\$5,195	\$4,676	\$249*
IWA-4-S-TT-WH	Ideal ThinTop™ WashStation™ 4S with Four Tool Wash Kit in Designer White Resin / Resin+	\$4,995	\$4,496	\$249*
IWS-3-S-DD-12-S-TT-BA	Ideal ThinTop™ Workstation 3S + 12" DryDock. Drain Side, Five Tool Culinary Kit, One DryDock Tool in Natural Golden Bamboo	\$5,870	\$5,283	\$249*
IWS-3-S-DD-12-S-TT-GR	Ideal ThinTop™ Workstation 3S + 12" DryDock. Drain Side, Five Tool Culinary Kit, One DryDock Tool in Exclusive Gray Resin	\$5,720	\$5,148	\$249*
IWS-3-S-DD-12-S-TT-GT	Ideal ThinTop™ Workstation 3S + 12" DryDock. Drain Side, Five Tool Culinary Kit, One DryDock Tool in Graphite Wood Composite	\$5,870	\$5,283	\$249*
IWS-3-S-DD-12-S-TT-WA	Ideal ThinTop™ Workstation 3S + 12" DryDock. Drain Side, Five Tool Culinary Kit, One DryDock Tool in American Black Walnut	\$6,620	\$5,958	\$249*
IWS-3-S-DD-12-S-TT-WH	Ideal ThinTop™ Workstation 3S + 12" DryDock. Drain Side, Five Tool Culinary Kit, One DryDock Tool in Designer White Resin	\$5,720	\$5,148	\$249*
IWS-3-S-TT-BA	Ideal ThinTop™ Workstation 3S with Five Tool Culinary Kit in Natural Golden Bamboo	\$4,395	\$3,956	\$99
IWS-3-S-TT-GR	Ideal ThinTop™ Workstation 3S with Five Tool Culinary Kit in Exclusive Gray Resin	\$4,095	\$3,686	\$99
IWS-3-S-TT-GT	Ideal ThinTop™ Workstation 3S with Five Tool Culinary Kit in Graphite Wood Composite	\$4,395	\$3,956	\$99
IWS-3-S-TT-WA	Ideal ThinTop™ Workstation 3S with Five Tool Culinary Kit in American Black Walnut	\$4,795	\$4,316	\$99
IWS-3-S-TT-WH	Ideal ThinTop™ Workstation 3S with Five Tool Culinary Kit in Designer White Resin	\$4,095	\$3,686	\$99
IWS-4-S-TT-BA	Ideal ThinTop™ Workstation 4S with Five Tool Culinary Kit in Natural Golden Bamboo	\$5,395	\$4,856	\$249*
IWS-4-S-TT-GR	Ideal ThinTop™ Workstation 4S with Five Tool Culinary Kit in Exclusive Gray Resin	\$5,095	\$4,586	\$249*
IWS-4-S-TT-GT	Ideal ThinTop™ Workstation 4S with Five Tool Culinary Kit in Graphite Wood Composite	\$5,395	\$4,856	\$249*
IWS-4-S-TT-WA	Ideal ThinTop™ Workstation 4S with Five Tool Culinary Kit in American Black Walnut	\$5,795	\$5,216	\$249*
IWS-4-S-TT-WH	Ideal ThinTop™ Workstation 4S with Five Tool Culinary Kit in Designer White Resin	\$5,095	\$4,586	\$249*
IWS-5-S-TT-BA	Ideal ThinTop™ Workstation 5S with Eight Tool Culinary Kit in Natural Golden Bamboo	\$6,495	\$5,846	\$249*
IWS-5-S-TT-GR	Ideal ThinTop™ Workstation 5S with Eight Tool Culinary Kit in Exclusive Gray Resin	\$6,095	\$5,486	\$249*
IWS-5-S-TT-GT	Ideal ThinTop™ Workstation 5S with Eight Tool Culinary Kit in Graphite Wood Composite	\$6,495	\$5,846	\$249*
IWS-5-S-TT-WA	Ideal ThinTop™ Workstation 5S with Eight Tool Culinary Kit in American Black Walnut	\$6,995	\$6,296	\$249*
IWS-5-S-TT-WH	Ideal ThinTop™ Workstation 5S with Eight Tool Culinary Kit in Designer White Resin	\$6,095	\$5,486	\$249*
KSO-18-C-TT-SS	Basin Portion of IBS 18C TT in Angel Finish 316L Stainless Steel	\$2,295	\$2,066	\$54
KSO-3-S-DS-12-S-TT-SS	Basin Portion of IWS 3S + DD12 TT, IWA 3S + DD12 TT in Angel Finish 316L Stainless Steel	\$4,695	\$4,226	\$204*
KSO-3-S-TT-SS	Basin Portion of IWS 3S TT, IWA 3S TT in Angel Finish 316L Stainless Steel	\$3,195	\$2,876	\$54
KSO-4-S-TT-SS	Basin Portion of IWS 4S TT, IWA 4S TT in Angel Finish 316L Stainless Steel	\$4,195	\$3,776	\$204*
KSO-5-S-TT-SS	Basin Portion of IWS 5S TT in Angel Finish 316L Stainless Steel	\$4,795	\$4,316	\$204*
WKT-4T-BA	Wash Kit including Four Tools for IWA 3S TT, 3S + DD12 TT, 4S TT in Natural Golden Bamboo / Exclusive Gray Resin+	\$900	\$810	\$45
WKT-4T-GR	Wash Kit including Four Tools for IWA 3S TT, 3S + DD12 TT, 4S TT in Exclusive Gray Resin / Resin+	\$800	\$720	\$45
WKT-4T-GT	Wash Kit including Four Tools for IWA 3S TT, 3S + DD12 TT, 4S TT in Graphite Wood Composite / Graphite Resin+	\$900	\$810	\$45
WKT-4T-WA	Wash Kit including Four Tools for IWA 3S TT, 3S + DD12 TT, 4S TT in American Black Walnut / Graphite Resin+	\$1,000	\$900	\$45
WKT-4T-WH	Wash Kit including Four Tools for IWA 3S TT, 3S + DD12 TT, 4S TT in Designer White Resin / Resin+	\$800	\$720	\$45

Upper Deck.

Product code	Description	MSRP	UMRP	Freight
UD-06-I-BA	Upper Deck. 6" x 19" Section in Natural Golden Bamboo	\$175	\$158	\$25
UD-09-I-BA	Upper Deck. 9" x 19" Section in Natural Golden Bamboo	\$175	\$158	\$25
UD-1-1P-BA	Upper Deck. One Piece Set for IHS in Natural Golden Bamboo	\$150	\$135	\$25
UD-12-I-BA	Upper Deck. 12" x 19" Section in Natural Golden Bamboo	\$200	\$180	\$25
UD-18-2P-BA	Upper Deck. Two Piece Set for IBS 18C in Natural Golden Bamboo	\$350	\$315	\$35
UD-18-I-BA	Upper Deck. 18" x 19" Section in Natural Golden Bamboo	\$225	\$203	\$25
UD-2-2P-BA	Upper Deck. Two Piece Set for IWS 2C, IWA 2C, IBS 2C in Natural Golden Bamboo	\$400	\$360	\$35
UD-20-C-I-BA	Upper Deck. 20" x 19" Section for Corner in Natural Golden Bamboo	\$300	\$270	\$25
UD-24-I-BA	Upper Deck. 24" x 19" Section in Natural Golden Bamboo	\$275	\$248	\$25
UD-30-12-3P-BA	Upper Deck. Three Piece Set for IWS 30S + DD12, IWA 30S + DD12 in Natural Golden Bamboo	\$625	\$563	\$35
UD-30-18-3P-BA	Upper Deck. Three Piece Set for IWS 30S + DD18, IWA 30S + DD18 in Natural Golden Bamboo	\$650	\$585	\$35
UD-30-2P-BA	Upper Deck. Two Piece Set for IWS 30S, IWA 30S in Natural Golden Bamboo	\$425	\$383	\$35
UD-3-12-3P-BA	Upper Deck. Three Piece Set for IWS 3S + DD12, IWA 3S + DD12 in Natural Golden Bamboo	\$650	\$585	\$35
UD-3-18-3P-BA	Upper Deck. Three Piece Set for IWS 3S + DD18, IWA 3S + DD18 in Natural Golden Bamboo	\$675	\$608	\$35
UD-3-2P-BA	Upper Deck. Two Piece Set for IWS 3S, IWA 3S in Natural Golden Bamboo	\$450	\$405	\$35
UD-4-12-3P-BA	Upper Deck. Three Piece Set for IWS 4S + DD12, IWA 4S + DD12 in Natural Golden Bamboo	\$750	\$675	\$35
UD-4-18-3P-BA	Upper Deck. Three Piece Set for IWS 4S + DD18, IWA 4S + DD18 in Natural Golden Bamboo	\$775	\$698	\$35
UD-4-2P-BA	Upper Deck. Two Piece Set for IWS 4S, IWA 4S, 4D, IWW 4D in Natural Golden Bamboo</			

Product Index

Sorted by product category

Upper Deck

Product code	Description	MSRP	UMRP	Freight
UD-1-1P-GR	Upper Deck. One Piece Set for IHS in Exclusive Gray Resin	\$75	\$68	\$25
UD-12-1-GR	Upper Deck. 12" x 19" Section in Exclusive Gray Resin	\$125	\$113	\$25
UD-18-2P-GR	Upper Deck. Two Piece Set for IBS 18C in Exclusive Gray Resin	\$200	\$180	\$35
UD-18-1-GR	Upper Deck. 18" x 19" Section in Exclusive Gray Resin	\$150	\$135	\$25
UD-2-2P-GR	Upper Deck. Two Piece Set for IWS 2C, IWA 2C, IBS 2C in Exclusive Gray Resin	\$250	\$225	\$35
UD-20-C-I-GR	Upper Deck. 20" x 19" Section for Corner in Exclusive Gray Resin	\$275	\$248	\$25
UD-24-1-GR	Upper Deck. 24" x 19" Section in Exclusive Gray Resin	\$200	\$180	\$25
UD-30-12-3P-GR	Upper Deck. Three Piece Set for IWS 30S + DD12, IWA 30S + DD12 in Exclusive Gray Resin	\$400	\$360	\$35
UD-30-18-3P-GR	Upper Deck. Three Piece Set for IWS 30S + DD18, IWA 30S + DD18 in Exclusive Gray Resin	\$425	\$383	\$35
UD-30-2P-GR	Upper Deck. Two Piece Set for IWS 30S, IWA 30S in Exclusive Gray Resin	\$275	\$248	\$35
UD-3-12-3P-GR	Upper Deck. Three Piece Set for IWS 3S + DD12, IWA 3S + DD12 in Exclusive Gray Resin	\$425	\$383	\$35
UD-3-18-3P-GR	Upper Deck. Three Piece Set for IWS 3S + DD18, IWA 3S + DD18 in Exclusive Gray Resin	\$450	\$405	\$35
UD-3-2P-GR	Upper Deck. Two Piece Set for IWS 3S, IWA 3S in Exclusive Gray Resin	\$300	\$270	\$35
UD-4-12-3P-GR	Upper Deck. Three Piece Set for IWS 4S + DD12, IWA 4S + DD12 in Exclusive Gray Resin	\$525	\$473	\$35
UD-4-18-3P-GR	Upper Deck. Three Piece Set for IWS 4S + DD18, IWA 4S + DD18 in Exclusive Gray Resin	\$550	\$495	\$35
UD-4-2P-GR	Upper Deck. Two Piece Set for IWS 4S, IWA 4S, 4D, IWW 4D in Exclusive Gray Resin	\$400	\$360	\$35
UD-4X3-3P-GR	Upper Deck. Three Piece Set for IWS 3X4C, 4X3C, IWA 3X4C, 4X3C in Exclusive Gray Resin	\$600	\$540	\$35
UD-4X4-3P-GR	Upper Deck. Three Piece Set for IWS 4X4C, IWA 4X4C in Exclusive Gray Resin	\$675	\$608	\$35
UD-5-3P-GR	Upper Deck. Three Piece Set for IWS 5S, IWW 5D in Exclusive Gray Resin	\$500	\$450	\$35
UD-6-3P-GR	Upper Deck. Three Piece Set for IWS 6S, IWW 6D in Exclusive Gray Resin	\$600	\$540	\$35
UD-7-4P-GR	Upper Deck. Four Piece Set for IWS 7S, IWW 7D in Exclusive Gray Resin	\$700	\$630	\$35
UD-06-I-GT	Upper Deck. 6" x 19" Section in Graphite Wood Composite	\$175	\$158	\$25
UD-09-I-GT	Upper Deck. 9" x 19" Section in Graphite Wood Composite	\$175	\$158	\$25
UD-1-1P-GT	Upper Deck. One Piece Set for IHS in Graphite Wood Composite	\$150	\$135	\$25
UD-12-1-GT	Upper Deck. 12" x 19" Section in Graphite Wood Composite	\$200	\$180	\$25
UD-18-2P-GT	Upper Deck. Two Piece Set for IBS 18C in Graphite Wood Composite	\$350	\$315	\$35
UD-18-1-GT	Upper Deck. 18" x 19" Section in Graphite Wood Composite	\$225	\$203	\$25
UD-2-2P-GT	Upper Deck. Two Piece Set for IWS 2C, IWA 2C, IBS 2C in Graphite Wood Composite	\$400	\$360	\$35
UD-20-C-I-GT	Upper Deck. 20" x 19" Section for Corner in Graphite Wood Composite	\$300	\$270	\$25
UD-24-1-GT	Upper Deck. 24" x 19" Section in Graphite Wood Composite	\$275	\$248	\$25
UD-30-12-3P-GT	Upper Deck. Three Piece Set for IWS 30S + DD12, IWA 30S + DD12 in Graphite Wood Composite	\$625	\$563	\$35
UD-30-18-3P-GT	Upper Deck. Three Piece Set for IWS 30S + DD18, IWA 30S + DD18 in Graphite Wood Composite	\$650	\$585	\$35
UD-30-2P-GT	Upper Deck. Two Piece Set for IWS 30S, IWA 30S in Graphite Wood Composite	\$425	\$383	\$35
UD-3-12-3P-GT	Upper Deck. Three Piece Set for IWS 3S + DD12, IWA 3S + DD12 in Graphite Wood Composite	\$650	\$585	\$35
UD-3-18-3P-GT	Upper Deck. Three Piece Set for IWS 3S + DD18, IWA 3S + DD18 in Graphite Wood Composite	\$675	\$608	\$35
UD-3-2P-GT	Upper Deck. Two Piece Set for IWS 3S, IWA 3S in Graphite Wood Composite	\$450	\$405	\$35
UD-4-12-3P-GT	Upper Deck. Three Piece Set for IWS 4S + DD12, IWA 4S + DD12 in Graphite Wood Composite	\$750	\$675	\$35
UD-4-18-3P-GT	Upper Deck. Three Piece Set for IWS 4S + DD18, IWA 4S + DD18 in Graphite Wood Composite	\$775	\$698	\$35
UD-4-2P-GT	Upper Deck. Two Piece Set for IWS 4S, IWA 4S, 4D, IWW 4D in Graphite Wood Composite	\$550	\$495	\$35
UD-4X3-3P-GT	Upper Deck. Three Piece Set for IWS 3X4C, 4X3C, IWA 3X4C, 4X3C in Graphite Wood Composite	\$775	\$698	\$35
UD-4X4-3P-GT	Upper Deck. Three Piece Set for IWS 4X4C, IWA 4X4C in Graphite Wood Composite	\$850	\$765	\$35
UD-5-3P-GT	Upper Deck. Three Piece Set for IWS 5S, IWW 5D in Graphite Wood Composite	\$725	\$653	\$35
UD-6-3P-GT	Upper Deck. Three Piece Set for IWS 6S, IWW 6D in Graphite Wood Composite	\$825	\$743	\$35
UD-7-4P-GT	Upper Deck. Four Piece Set for IWS 7S, IWW 7D in Graphite Wood Composite	\$1,000	\$900	\$35
UD-06-I-WA	Upper Deck. 6" x 19" Section in American Black Walnut	\$275	\$248	\$25
UD-09-I-WA	Upper Deck. 9" x 19" Section in American Black Walnut	\$275	\$248	\$25
UD-1-1P-WA	Upper Deck. One Piece Set for IHS in American Black Walnut	\$250	\$225	\$25
UD-12-1-WA	Upper Deck. 12" x 19" Section in American Black Walnut	\$300	\$270	\$25
UD-18-2P-WA	Upper Deck. Two Piece Set for IBS 18C in American Black Walnut	\$550	\$495	\$35
UD-18-1-WA	Upper Deck. 18" x 19" Section in American Black Walnut	\$325	\$293	\$25
UD-2-2P-WA	Upper Deck. Two Piece Set for IWS 2C, IWA 2C, IBS 2C in American Black Walnut	\$600	\$540	\$35
UD-20-C-I-WA	Upper Deck. 20" x 19" Section for Corner in American Black Walnut	\$400	\$360	\$25
UD-24-1-WA	Upper Deck. 24" x 19" Section in American Black Walnut	\$375	\$338	\$25
UD-30-12-3P-WA	Upper Deck. Three Piece Set for IWS 30S + DD12, IWA 30S + DD12 in American Black Walnut	\$925	\$833	\$35
UD-30-18-3P-WA	Upper Deck. Three Piece Set for IWS 30S + DD18, IWA 30S + DD18 in American Black Walnut	\$950	\$855	\$35
UD-30-2P-WA	Upper Deck. Two Piece Set for IWS 30S, IWA 30S in American Black Walnut	\$625	\$563	\$35
UD-3-12-3P-WA	Upper Deck. Three Piece Set for IWS 3S + DD12, IWA 3S + DD12 in American Black Walnut	\$950	\$855	\$35
UD-3-18-3P-WA	Upper Deck. Three Piece Set for IWS 3S + DD18, IWA 3S + DD18 in American Black Walnut	\$975	\$878	\$35
UD-3-2P-WA	Upper Deck. Two Piece Set for IWS 3S, IWA 3S in American Black Walnut	\$650	\$585	\$35
UD-4-12-3P-WA	Upper Deck. Three Piece Set for IWS 4S + DD12, IWA 4S + DD12 in American Black Walnut	\$1,050	\$945	\$35
UD-4-18-3P-WA	Upper Deck. Three Piece Set for IWS 4S + DD18, IWA 4S + DD18 in American Black Walnut	\$1,075	\$968	\$35
UD-4-2P-WA	Upper Deck. Two Piece Set for IWS 4S, IWA 4S, 4D, IWW 4D in American Black Walnut	\$750	\$675	\$35
UD-4X3-3P-WA	Upper Deck. Three Piece Set for IWS 3X4C, 4X3C, IWA 3X4C, 4X3C in American Black Walnut	\$1,075	\$968	\$35
UD-4X4-3P-WA	Upper Deck. Three Piece Set for IWS 4X4C, IWA 4X4C in American Black Walnut	\$1,150	\$1,035	\$35
UD-5-3P-WA	Upper Deck. Three Piece Set for IWS 5S, IWW 5D in American Black Walnut	\$1,025	\$923	\$35
UD-6-3P-WA	Upper Deck. Three Piece Set for IWS 6S, IWW 6D in American Black Walnut	\$1,125	\$1,013	\$35
UD-7-4P-WA	Upper Deck. Four Piece Set for IWS 7S, IWW 7D in American Black Walnut	\$1,400	\$1,260	\$35
UD-06-I-WH	Upper Deck. 6" x 19" Section in Designer White Resin	\$100	\$90	\$25
UD-09-I-WH	Upper Deck. 9" x 19" Section in Designer White Resin	\$100	\$90	\$25
UD-1-1P-WH	Upper Deck. One Piece Set for IHS in Designer White Resin	\$75	\$68	\$25
UD-12-1-WH	Upper Deck. 12" x 19" Section in Designer White Resin	\$125	\$113	\$25
UD-18-2P-WH	Upper Deck. Two Piece Set for IBS 18C in Designer White Resin	\$200	\$180	\$35
UD-18-1-WH	Upper Deck. 18" x 19" Section in Designer White Resin	\$150	\$135	\$25
UD-2-2P-WH	Upper Deck. Two Piece Set for IWS 2C, IWA 2C, IBS 2C in Designer White Resin	\$250	\$225	\$35
UD-20-C-I-WH	Upper Deck. 20" x 19" Section for Corner in Designer White Resin	\$275	\$248	\$25

Product Index

Sorted by product category

Upper Deck

Product code	Description	MSRP	UMRP	Freight
UD-24-I-WH	Upper Deck. 24" x 19" Section in Designer White Resin	\$200	\$180	\$25
UD-30-12-3P-WH	Upper Deck. Three Piece Set for IWS 30S + DD12, IWA 30S + DD12 in Designer White Resin	\$400	\$360	\$35
UD-30-18-3P-WH	Upper Deck. Three Piece Set for IWS 30S + DD18, IWA 30S + DD18 in Designer White Resin	\$425	\$383	\$35
UD-30-2P-WH	Upper Deck. Two Piece Set for IWS 30S, IWA 30S in Designer White Resin	\$275	\$248	\$35
UD-3-12-3P-WH	Upper Deck. Three Piece Set for IWS 3S + DD12, IWA 3S + DD12 in Designer White Resin	\$425	\$383	\$35
UD-3-18-3P-WH	Upper Deck. Three Piece Set for IWS 3S + DD18, IWA 3S + DD18 in Designer White Resin	\$450	\$405	\$35
UD-3-2P-WH	Upper Deck. Two Piece Set for IWS 3S, IWA 3S in Designer White Resin	\$300	\$270	\$35
UD-4-12-3P-WH	Upper Deck. Three Piece Set for IWS 4S + DD12, IWA 4S + DD12 in Designer White Resin	\$525	\$473	\$35
UD-4-18-3P-WH	Upper Deck. Three Piece Set for IWS 4S + DD18, IWA 4S + DD18 in Designer White Resin	\$550	\$495	\$35
UD-4-2P-WH	Upper Deck. Two Piece Set for IWS 4S, IWA 4S, 4D, IWW 4D in Designer White Resin	\$400	\$360	\$35
UD-4X3-3P-WH	Upper Deck. Three Piece Set for IWS 3X4C, 4X3C, IWA 3X4C, 4X3C in Designer White Resin	\$600	\$540	\$35
UD-4X4-3P-WH	Upper Deck. Three Piece Set for IWS 4X4C, IWA 4X4C in Designer White Resin	\$675	\$608	\$35
UD-5-3P-WH	Upper Deck. Three Piece Set for IWS 5S, IWW 5D in Designer White Resin	\$500	\$450	\$35
UD-6-3P-WH	Upper Deck. Three Piece Set for IWS 6S, IWW 6D in Designer White Resin	\$600	\$540	\$35
UD-7-4P-WH	Upper Deck. Four Piece Set for IWS 7S, IWW 7D in Designer White Resin	\$700	\$630	\$35

Workstation Accessories

Product code	Description	MSRP	UMRP	Freight
A-DRN-MSS	Automatic Strainer Basket 3-1/2" with Remote Pop-up Knob and 27-1/2" Cable in Matte Stainless Steel	\$220	\$198	\$15
A-DRN-PSS	Automatic Strainer Basket 3-1/2" with Remote Pop-up Knob and 27-1/2" Cable in Polished Stainless Steel	\$240	\$216	\$15
BG-05-N-SS	Bottom Grate Section 5-1/2" x 15-1/2" in Stainless Steel	\$200	\$180	\$25
BG-11-N-SS	Bottom Grate Section 11-1/2" x 15-1/2" for IWS 4S, 4X4C, 6S, IWA 4S, 4X4C, IWW 6D in Stainless Steel	\$250	\$225	\$25
BG-13-C-SS	Bottom Grate Section 13-1/2" x 15-1/2" for IBS 18C in Stainless Steel	\$250	\$225	\$25
BG-18-C-1-SS	Bottom Grate One Section Set for IBS 18C in Stainless Steel	\$250	\$225	\$25
BG-2-C-1-SS	Bottom Grate One Section Set for IWS 2C, IWA 2C, IBS 2C in Stainless Steel	\$300	\$270	\$25
BG-20-C-SS	Bottom Grate Section 20" x 15-1/2" for IWS 2C, IWA 2C, 4D, IWW 4D, 5D, 6D, 7D, IBS 2C in Stainless Steel	\$300	\$270	\$25
BG-23-N-SS	Bottom Grate Section 23-1/2" x 15-1/2" for IWS 5S, 6S, 7S, IWW 7D in Stainless Steel	\$300	\$270	\$25
BG-25-N-SS	Bottom Grate Section 25-1/2" x 15-1/2" for IWS 3X4C, 4X3C, 4X4C, IWA 3X4C, 4X3C, 4X4C in Stainless Steel	\$325	\$293	\$25
BG-25-S-SS	Bottom Grate Section 25-1/2" x 15-1/2" for IWS 30S, IWA 30S in Stainless Steel	\$325	\$293	\$25
BG-29-S-SS	Bottom Grate Section 29" x 15-1/2" for IWS 3X4C, 4X3C, 4X4C, IWA 3X4C, 4X3C, 4X4C in Stainless Steel	\$350	\$315	\$25
BG-30-S-1-SS	Bottom Grate One Section Set for IWS 30S, IWA 30S in Stainless Steel	\$325	\$293	\$25
BG-3-S-1-SS	Bottom Grate One Section Set for IWS 3S, IWA 3S in Stainless Steel	\$350	\$315	\$25
BG-31-S-SS	Bottom Grate Section 31-1/2" x 15-1/2" for IWS 3S, 4S, 5S, 6S, 7S, IWA 3S, 4S, IWW 5D, 6D, 7D in Stainless Steel	\$350	\$315	\$25
BG-4-D-2-SS	Bottom Grate Two Section Set for IWA 4D, IWW 4D in Stainless Steel	\$600	\$540	\$35
BG-4-S-2-SS	Bottom Grate Two Section Set for IWS 4S, IWA 4S in Stainless Steel	\$600	\$540	\$35
BG-4X3-C-2-SS	Bottom Grate Two Section Set for IWS 3X4C, 4X3C, IWA 3X4C, 4X3C in Stainless Steel	\$675	\$608	\$35
BG-4X4-C-3-SS	Bottom Grate Three Section Set for IWS 4X4C, IWA 4X4C in Stainless Steel	\$925	\$833	\$35
BG-5-D-2-SS	Bottom Grate Two Section Set for IWW 5D in Stainless Steel	\$650	\$585	\$35
BG-5-S-2-SS	Bottom Grate Two Section Set for IWS 5S in Stainless Steel	\$650	\$585	\$35
BG-6-D-3-SS	Bottom Grate Three Section Set for IWW 6D in Stainless Steel	\$900	\$810	\$35
BG-6-S-3-SS	Bottom Grate Three Section Set for IWS 6S in Stainless Steel	\$900	\$810	\$35
BG-7-D-3-SS	Bottom Grate Three Section Set for IWW 7D in Stainless Steel	\$950	\$855	\$35
BG-7-S-3-SS	Bottom Grate Three Section Set for IWS 7S in Stainless Steel	\$950	\$855	\$35
G-DRN-MSS	3-in-1 Garbage Disposal Flange with Strainer Basket 3-1/2" in Angel Finish Stainless Steel	\$110	\$99	\$15
H-DRN-MSS	HydroStation™ 2" Drain & Plate in Angel Finish Stainless Steel	\$55	\$50	\$15
M-DRN-MSS	Manual Strainer Basket 3-1/2" in Angel Finish Stainless Steel	\$110	\$99	\$15

Optional Culinary Tools

Product code	Description	MSRP	UMRP	Freight
BC-12-L-BA	Mixing Bowl 11" and Colander 11" in Stainless Steel, Lower Tier Platform 12-1/4" x 17" Set in Natural Golden Bamboo	\$275	\$248	\$25
BC-12-L-GR	Mixing Bowl 11" and Colander 11" in Stainless Steel, Lower Tier Platform 12-1/4" x 17" Set in Exclusive Gray Resin	\$225	\$203	\$25
BC-12-L-GT	Mixing Bowl 11" and Colander 11" in Stainless Steel, Lower Tier Platform 12-1/4" x 17" Set in Graphite Wood Composite	\$275	\$248	\$25
BC-12-L-WA	Mixing Bowl 11" and Colander 11" in Stainless Steel, Lower Tier Platform 12-1/4" x 17" Set in American Black Walnut	\$350	\$315	\$25
BC-12-L-WH	Mixing Bowl 11" and Colander 11" in Stainless Steel, Lower Tier Platform 12-1/4" x 17" Set in Designer White Resin	\$225	\$203	\$25
BC-17-D-BA	Mixing Bowl 11" and Colander 11" in Stainless Steel, Dual Tier Platform 17" x 18" Set in Natural Golden Bamboo	\$300	\$270	\$25
BC-17-D-GR	Mixing Bowl 11" and Colander 11" in Stainless Steel, Dual Tier Platform 17" x 18" Set in Exclusive Gray Resin	\$250	\$225	\$25
BC-17-D-GT	Mixing Bowl 11" and Colander 11" in Stainless Steel, Dual Tier Platform 17" x 18" Set in Graphite Wood Composite	\$300	\$270	\$25
BC-17-D-WA	Mixing Bowl 11" and Colander 11" in Stainless Steel, Dual Tier Platform 17" x 18" Set in American Black Walnut	\$375	\$338	\$25
BC-17-D-WH	Mixing Bowl 11" and Colander 11" in Stainless Steel, Dual Tier Platform 17" x 18" Set in Designer White Resin	\$250	\$225	\$25
CB-12-U-BA	Upper Tier Cutting Board 12-1/4" x 18" with Juice Groove on one side in Natural Golden Bamboo	\$250	\$225	\$25
CB-12-U-GR	Upper Tier Cutting Board 12-1/4" x 18" with Juice Groove on one side in Exclusive Gray Resin	\$175	\$158	\$25
CB-12-U-GT	Upper Tier Cutting Board 12-1/4" x 18" with Juice Groove on one side in Graphite Wood Composite	\$250	\$225	\$25
CB-12-U-WA	Upper Tier Cutting Board 12-1/4" x 18" with Juice Groove on one side in American Black Walnut	\$350	\$315	\$25
CB-12-U-WH	Upper Tier Cutting Board 12-1/4" x 18" with Juice Groove on one side in Designer White Resin	\$175	\$158	\$25
CB-17-D-BA	Dual Tier Cutting Board 17" x 18" with Juice Groove on one side in Natural Golden Bamboo	\$275	\$248	\$25
CB-17-D-GR	Dual Tier Cutting Board 17" x 18" with Juice Groove on one side in Exclusive Gray Resin	\$200	\$180	\$25
CB-17-D-GT	Dual Tier Cutting Board 17" x 18" with Juice Groove on one side in Graphite Wood Composite	\$275	\$248	\$25
CB-17-D-WA	Dual Tier Cutting Board 17" x 18" with Juice Groove on one side in American Black Walnut	\$375	\$338	\$25
CB-17-D-WH	Dual Tier Cutting Board 17" x 18" with Juice Groove on one side in Designer White Resin	\$200	\$180	\$25
CB-18-C-BA	Upper Tier Corner Cutting Board 18-1/4" x 18-1/4" with Juice Groove on one side in Natural Golden Bamboo	\$300	\$270	\$25
CB-18-C-GR	Upper Tier Corner Cutting Board 18-1/4" x 18-1/4" with Juice Groove on one side in Exclusive Gray Resin	\$225	\$203	\$25
CB-18-C-GT	Upper Tier Corner Cutting Board 18-1/4" x 18-1/4" with Juice Groove on one side in Graphite Wood Composite	\$300	\$270	\$25
CB-18-C-WA	Upper Tier Corner Cutting Board 18-1/4" x 18-1/4" with Juice Groove on one side in American Black Walnut	\$400	\$360	\$25
CB-18-C-WH	Upper Tier Corner Cutting Board 18-1/4" x 18-1/4" with Juice Groove on one side in Designer White Resin	\$225	\$203	\$25
CH-12-U-BA	Upper Tier 2" thick Chef's Block 12-1/4" x 18" x 2" with Juice Groove on one side in Natural Golden Bamboo	\$375	\$338	\$25

Product Index

Sorted by product category

Optional Culinary Tools

Product code	Description	MSRP	UMRP	Freight
CH-12-U-WA	Upper Tier 2" thick Chef's Block 12-1/4" x 18" x 2" with Juice Groove on one side in American Black Walnut	\$525	\$473	\$25
CH-17-D-BA	Dual Tier 2" thick Chef's Block 17" x 18" x 2" with Juice Groove on one side in Natural Golden Bamboo	\$450	\$405	\$25
CH-17-D-WA	Dual Tier 2" thick Chef's Block 17" x 18" x 2" with Juice Groove on one side in American Black Walnut	\$600	\$540	\$25
CH-18-C-BA	Upper Tier 2" thick Corner Chef's Block 18-1/4" x 18-1/4" x 2" with Juice Groove on one side in Natural Golden Bamboo	\$525	\$473	\$25
CH-18-C-WA	Upper Tier 2" thick Corner Chef's Block 18-1/4" x 18-1/4" x 2" with Juice Groove on one side in American Black Walnut	\$675	\$608	\$25
CKT-12-ADA-BA	Small ADA Culinary Kit including Five Tools in Natural Golden Bamboo	\$1,200	\$1,080	\$45
CKT-12-ADA-GR	Small ADA Culinary Kit including Five Tools in Exclusive Gray Resin	\$900	\$810	\$45
CKT-12-ADA-GT	Small ADA Culinary Kit including Five Tools in Graphite Wood Composite	\$1,200	\$1,080	\$45
CKT-12-ADA-WA	Small ADA Culinary Kit including Five Tools in American Black Walnut	\$1,600	\$1,440	\$45
CKT-12-ADA-WH	Small ADA Culinary Kit including Five Tools in Designer White Resin	\$900	\$810	\$45
CKT-17-ADA-BA	Large ADA Culinary Kit including Eight Tools in Natural Golden Bamboo	\$1,700	\$1,530	\$45
CKT-17-ADA-GR	Large ADA Culinary Kit including Eight Tools in Exclusive Gray Resin	\$1,300	\$1,170	\$45
CKT-17-ADA-GT	Large ADA Culinary Kit including Eight Tools in Graphite Wood Composite	\$1,700	\$1,530	\$45
CKT-17-ADA-WA	Large ADA Culinary Kit including Eight Tools in American Black Walnut	\$2,200	\$1,980	\$45
CKT-17-ADA-WH	Large ADA Culinary Kit including Eight Tools in Designer White Resin	\$1,300	\$1,170	\$45
DR-06-L-BA	Lower Tier Mini Drying Rack 6" x 17" in Natural Golden Bamboo	\$225	\$203	\$25
DR-06-L-GR	Lower Tier Mini Drying Rack 6" x 17" in Exclusive Gray Resin	\$175	\$158	\$25
DR-06-L-GT	Lower Tier Mini Drying Rack 6" x 17" in Graphite Wood Composite	\$225	\$203	\$25
DR-06-L-WA	Lower Tier Mini Drying Rack 6" x 17" in American Black Walnut	\$275	\$248	\$25
DR-06-L-WH	Lower Tier Mini Drying Rack 6" x 17" in Designer White Resin	\$175	\$158	\$25
DR-09-U-BA	Upper Tier Drying Rack 9-1/4" x 18" in Natural Golden Bamboo	\$275	\$248	\$25
DR-09-U-GR	Upper Tier Drying Rack 9-1/4" x 18" in Exclusive Gray Resin	\$225	\$203	\$25
DR-09-U-GT	Upper Tier Drying Rack 9-1/4" x 18" in Graphite Wood Composite	\$275	\$248	\$25
DR-09-U-WA	Upper Tier Drying Rack 9-1/4" x 18" in American Black Walnut	\$325	\$293	\$25
DR-09-U-WH	Upper Tier Drying Rack 9-1/4" x 18" in Designer White Resin	\$225	\$203	\$25
DR-12-L-BA	Lower Tier Drying Rack 12-1/4" x 17" in Natural Golden Bamboo	\$275	\$248	\$25
DR-12-L-GR	Lower Tier Drying Rack 12-1/4" x 17" in Exclusive Gray Resin	\$225	\$203	\$25
DR-12-L-GT	Lower Tier Drying Rack 12-1/4" x 17" in Graphite Wood Composite	\$275	\$248	\$25
DR-12-L-WA	Lower Tier Drying Rack 12-1/4" x 17" in American Black Walnut	\$325	\$293	\$25
DR-12-L-WH	Lower Tier Drying Rack 12-1/4" x 17" in Designer White Resin	\$225	\$203	\$25
DR-12-U-BA	Upper Tier Drying Rack 12-1/4" x 18" in Natural Golden Bamboo	\$275	\$248	\$25
DR-12-U-GR	Upper Tier Drying Rack 12-1/4" x 18" in Exclusive Gray Resin	\$225	\$203	\$25
DR-12-U-GT	Upper Tier Drying Rack 12-1/4" x 18" in Graphite Wood Composite	\$275	\$248	\$25
DR-12-U-WA	Upper Tier Drying Rack 12-1/4" x 18" in American Black Walnut	\$325	\$293	\$25
DR-12-U-WH	Upper Tier Drying Rack 12-1/4" x 18" in Designer White Resin	\$225	\$203	\$25
DR-17-D-BA	Dual Tier Drying Rack 17" x 18" in Natural Golden Bamboo	\$325	\$293	\$25
DR-17-D-GR	Dual Tier Drying Rack 17" x 18" in Exclusive Gray Resin	\$250	\$225	\$25
DR-17-D-GT	Dual Tier Drying Rack 17" x 18" in Graphite Wood Composite	\$325	\$293	\$25
DR-17-D-WA	Dual Tier Drying Rack 17" x 18" in American Black Walnut	\$375	\$338	\$25
DR-17-D-WH	Dual Tier Drying Rack 17" x 18" in Designer White Resin	\$250	\$225	\$25
DR-18-D-BA	Dual Tier Drying Rack 18" x 17" in Natural Golden Bamboo	\$325	\$293	\$25
DR-18-D-GR	Dual Tier Drying Rack 18" x 17" in Exclusive Gray Resin	\$250	\$225	\$25
DR-18-D-GT	Dual Tier Drying Rack 18" x 17" in Graphite Wood Composite	\$325	\$293	\$25
DR-18-D-WA	Dual Tier Drying Rack 18" x 17" in American Black Walnut	\$375	\$338	\$25
DR-18-D-WH	Dual Tier Drying Rack 18" x 17" in Designer White Resin	\$250	\$225	\$25
EKT-4T-BA	Entertainment Kit including Four Tools in Natural Golden Bamboo	\$1,050	\$945	\$45
EKT-4T-GR	Entertainment Kit including Four Tools in Exclusive Gray Resin	\$850	\$765	\$45
EKT-4T-GT	Entertainment Kit including Four Tools in Graphite Wood Composite	\$1,050	\$945	\$45
EKT-4T-WA	Entertainment Kit including Four Tools in American Black Walnut	\$1,250	\$1,125	\$45
EKT-4T-WH	Entertainment Kit including Four Tools in Designer White Resin	\$850	\$765	\$45
HS-13-U-AL	Upper Tier Half Sheet Pan 13" x 18" in Corrugated Aluminum	\$27	\$24	\$25
KB-03-C-BA	Countertop Recessed Magnetic Knife Block in Natural Golden Bamboo	\$175	\$158	\$25
KB-03-C-GT	Countertop Recessed Magnetic Knife Block in Graphite Wood Composite	\$175	\$158	\$25
KB-03-C-WA	Countertop Recessed Magnetic Knife Block in American Black Walnut	\$250	\$225	\$25
LKT-3T-BA	Corner Kit including Three Tools in Natural Golden Bamboo	\$750	\$675	\$45
LKT-3T-GR	Corner Kit including Three Tools in Exclusive Gray Resin	\$600	\$540	\$45
LKT-3T-GT	Corner Kit including Three Tools in Graphite Wood Composite	\$750	\$675	\$45
LKT-3T-WA	Corner Kit including Three Tools in American Black Walnut	\$900	\$810	\$45
LKT-3T-WH	Corner Kit including Three Tools in Designer White Resin	\$600	\$540	\$45
OKT-5T-GR	Outdoor Kit including Five Tools in Exclusive Gray Resin	\$800	\$720	\$45
OKT-5T-GT	Outdoor Kit including Five Tools in Graphite Wood Composite	\$1,000	\$900	\$45
OKT-5T-WH	Outdoor Kit including Five Tools in Designer White Resin	\$800	\$720	\$45
SB-06-U-BA	Upper Tier Garnish Board 6" x 18" with Four Stainless Steel Bowls 4" in Natural Golden Bamboo	\$300	\$270	\$25
SB-06-U-GR	Upper Tier Garnish Board 6" x 18" with Four Stainless Steel Bowls 4" in Exclusive Gray Resin	\$225	\$203	\$25
SB-06-U-GT	Upper Tier Garnish Board 6" x 18" with Four Stainless Steel Bowls 4" in Graphite Wood Composite	\$300	\$270	\$25
SB-06-U-WA	Upper Tier Garnish Board 6" x 18" with Four Stainless Steel Bowls 4" in American Black Walnut	\$350	\$315	\$25
SB-06-U-WH	Upper Tier Garnish Board 6" x 18" with Four Stainless Steel Bowls 4" in Designer White Resin	\$225	\$203	\$25
SB-09-U-BA	Upper Tier Condiment Serving Board 9" x 18" with Three Stainless Steel Containers and Lids in Natural Golden Bamboo	\$250	\$225	\$25
SB-09-U-GR	Upper Tier Condiment Serving Board 9" x 18" with Three Stainless Steel Containers and Lids in Exclusive Gray Resin	\$200	\$180	\$25
SB-09-U-GT	Upper Tier Condiment Serving Board 9" x 18" with Three Stainless Steel Containers and Lids in Graphite Wood Composite	\$250	\$225	\$25
SB-09-U-WA	Upper Tier Condiment Serving Board 9" x 18" with Three Stainless Steel Containers and Lids in American Black Walnut	\$300	\$270	\$25
SB-09-U-WH	Upper Tier Condiment Serving Board 9" x 18" with Three Stainless Steel Containers and Lids in Designer White Resin	\$200	\$180	\$25
SB-17-D-BA	Dual Tier Condiment Serving Board 17" x 18" with Six Stainless Steel Containers and Lids in Natural Golden Bamboo	\$350	\$315	\$25
SB-17-D-GR	Dual Tier Condiment Serving Board 17" x 18" with Six Stainless Steel Containers and Lids in Exclusive Gray Resin	\$275	\$248	\$25
SB-17-D-GT	Dual Tier Condiment Serving Board 17" x 18" with Six Stainless Steel Containers and Lids in Graphite Wood Composite	\$350	\$315	\$25

Product Index

Sorted by product category

Optional Culinary Tools

Product code	Description	MSRP	UMRP	Freight
SB-17-D-WA	Dual Tier Condiment Serving Board 17" x 18" with Six Stainless Steel Containers and Lids in American Black Walnut	\$425	\$383	\$25
SB-17-D-WH	Dual Tier Condiment Serving Board 17" x 18" with Six Stainless Steel Containers and Lids in Designer White Resin	\$275	\$248	\$25
UC-06-U-BA	Upper Tier Utensil Caddy 6" x 18" with Mini Grate and Two Cylinders in Natural Golden Bamboo	\$225	\$203	\$25
UC-06-U-GR	Upper Tier Utensil Caddy 6" x 18" with Mini Grate and Two Cylinders in Exclusive Gray Resin	\$175	\$158	\$25
UC-06-U-GT	Upper Tier Utensil Caddy 6" x 18" with Mini Grate and Two Cylinders in Graphite Wood Composite	\$225	\$203	\$25
UC-06-U-WA	Upper Tier Utensil Caddy 6" x 18" with Mini Grate and Two Cylinders in American Black Walnut	\$275	\$248	\$25
UC-06-U-WH	Upper Tier Utensil Caddy 6" x 18" with Mini Grate and Two Cylinders in Designer White Resin	\$175	\$158	\$25
WB-12-L-GR	Lower Tier Wash Bowl 12" x 17" in Exclusive Gray Resin+	\$215	\$194	\$25
WB-12-L-GT	Lower Tier Wash Bowl 12" x 17" in Graphite Resin+	\$215	\$194	\$25
WB-12-L-WH	Lower Tier Wash Bowl 12" x 17" in Designer White Resin+	\$215	\$194	\$25
WC-06-L-GR	Lower Tier Wash Caddy 6" x 17" in Exclusive Gray Resin+	\$185	\$167	\$25
WC-06-L-GT	Lower Tier Wash Caddy 6" x 17" in Graphite Resin+	\$185	\$167	\$25
WC-06-L-WH	Lower Tier Wash Caddy 6" x 17" in Designer White Resin+	\$185	\$167	\$25
WM-17-C-BA	Lower Tier Corner Wash & Serve Set with Wash Basin & Large Serving Bowl in Stainless Steel, Platform in Natural Golden Bamboo	\$525	\$473	\$25
WM-17-C-GR	Lower Tier Corner Wash & Serve Set with Wash Basin & Large Serving Bowl in Stainless Steel, Platform in Exclusive Gray Resin	\$450	\$405	\$25
WM-17-C-GT	Lower Tier Corner Wash & Serve Set with Wash Basin & Large Serving Bowl in Stainless Steel, Platform in Graphite Wood Composite	\$525	\$473	\$25
WM-17-C-WA	Lower Tier Corner Wash & Serve Set with Wash Basin & Large Serving Bowl in Stainless Steel, Platform in American Black Walnut	\$600	\$540	\$25
WM-17-C-WH	Lower Tier Corner Wash & Serve Set with Wash Basin & Large Serving Bowl in Stainless Steel, Platform in Designer White Resin	\$450	\$405	\$25
WM-17-D-BA	Dual Tier Wash & Serve Set with Wash Basin & Large Serving Bowl in Natural Golden Bamboo	\$500	\$450	\$25
WM-17-D-GR	Dual Tier Wash & Serve Set with Wash Basin & Large Serving Bowl in Stainless Steel, Platform in Exclusive Gray Resin	\$425	\$383	\$25
WM-17-D-GT	Dual Tier Wash & Serve Set with Wash Basin & Large Serving Bowl in Stainless Steel, Platform in Graphite Wood Composite	\$500	\$450	\$25
WM-17-D-WA	Dual Tier Wash & Serve Set with Wash Basin & Large Serving Bowl in Stainless Steel, Platform in American Black Walnut	\$575	\$518	\$25
WM-17-D-WH	Dual Tier Wash & Serve Set with Wash Basin & Large Serving Bowl in Stainless Steel, Platform in Designer White Resin	\$425	\$383	\$25

Taps

Product code	Description	MSRP	UMRP	Freight
IBT-D-BSS-EF	Ideal BarTap. Eco Flow in PVD Satin Black Stainless Steel	\$3,175	\$2,540	\$25
IBT-D-BSS-HF	Ideal BarTap. High Flow in PVD Satin Black Stainless Steel	\$3,175	\$2,540	\$25
IBT-D-GSS-EF	Ideal BarTap. Eco Flow in PVD Gun Metal Gray™ Stainless Steel	\$3,175	\$2,540	\$25
IBT-D-GSS-HF	Ideal BarTap. High Flow in PVD Gun Metal Gray™ Stainless Steel	\$3,175	\$2,540	\$25
IBT-D-MSS-EF	Ideal BarTap. Eco Flow in Matte Stainless Steel	\$2,275	\$1,820	\$25
IBT-D-MSS-HF	Ideal BarTap. High Flow in Matte Stainless Steel	\$2,275	\$1,820	\$25
IBT-D-PSS-EF	Ideal BarTap. Eco Flow in Polished Stainless Steel	\$2,275	\$1,820	\$25
IBT-D-PSS-HF	Ideal BarTap. High Flow in Polished Stainless Steel	\$2,275	\$1,820	\$25
IBT-D-RSS-EF	Ideal BarTap. Eco Flow in PVD Polished Rose Gold Stainless Steel	\$3,375	\$2,700	\$25
IBT-D-RSS-HF	Ideal BarTap. High Flow in PVD Polished Rose Gold Stainless Steel	\$3,375	\$2,700	\$25
IBT-D-YSS-EF	Ideal BarTap. Eco Flow in PVD Brushed Gold Stainless Steel	\$3,375	\$2,700	\$25
IBT-D-YSS-HF	Ideal BarTap. High Flow in PVD Brushed Gold Stainless Steel	\$3,375	\$2,700	\$25
IBTF-D-BSS-EF	Ideal BarTap. Eco Flow in PVD Satin Black Stainless Steel and Water Filtration System	\$3,395	\$2,716	\$25
IBTF-D-BSS-HF	Ideal BarTap. High Flow in PVD Satin Black Stainless Steel and Water Filtration System	\$3,395	\$2,716	\$25
IBTF-D-GSS-EF	Ideal BarTap. Eco Flow in PVD Gun Metal Gray™ Stainless Steel and Water Filtration System	\$3,395	\$2,716	\$25
IBTF-D-GSS-HF	Ideal BarTap. High Flow in PVD Gun Metal Gray™ Stainless Steel and Water Filtration System	\$3,395	\$2,716	\$25
IBTF-D-MSS-EF	Ideal BarTap. Eco Flow in Matte Stainless Steel and Water Filtration System	\$2,495	\$1,996	\$25
IBTF-D-MSS-HF	Ideal BarTap. High Flow in Matte Stainless Steel and Water Filtration System	\$2,495	\$1,996	\$25
IBTF-D-PSS-EF	Ideal BarTap. Eco Flow in Polished Stainless Steel and Water Filtration System	\$2,495	\$1,996	\$25
IBTF-D-PSS-HF	Ideal BarTap. High Flow in Polished Stainless Steel and Water Filtration System	\$2,495	\$1,996	\$25
IBTF-D-RSS-EF	Ideal BarTap. Eco Flow in PVD Polished Rose Gold Stainless Steel and Water Filtration System	\$3,595	\$2,876	\$25
IBTF-D-RSS-HF	Ideal BarTap. High Flow in PVD Polished Rose Gold Stainless Steel and Water Filtration System	\$3,595	\$2,876	\$25
IBTF-D-YSS-EF	Ideal BarTap. Eco Flow in PVD Brushed Gold Stainless Steel and Water Filtration System	\$3,595	\$2,876	\$25
IBTF-D-YSS-HF	Ideal BarTap. High Flow in PVD Brushed Gold Stainless Steel and Water Filtration System	\$3,595	\$2,876	\$25
IHT-D-BSS	Ideal Hot & Cold Tap in PVD Satin Black Stainless Steel and Ideal Digital Hot Water Tank™	\$2,675	\$2,140	\$25
IHT-D-GSS	Ideal Hot & Cold Tap in PVD Gun Metal Gray™ Stainless Steel and Ideal Digital Hot Water Tank™	\$2,675	\$2,140	\$25
IHT-D-MSS	Ideal Hot & Cold Tap in Matte Stainless Steel and Ideal Digital Hot Water Tank™	\$2,275	\$1,820	\$25
IHT-D-PSS	Ideal Hot & Cold Tap in Polished Stainless Steel and Ideal Digital Hot Water Tank™	\$2,275	\$1,820	\$25
IHT-D-RSS	Ideal Hot & Cold Tap in PVD Polished Rose Gold Stainless Steel and Ideal Digital Hot Water Tank™	\$2,875	\$2,300	\$25
IHT-D-YSS	Ideal Hot & Cold Tap in PVD Brushed Gold Stainless Steel and Ideal Digital Hot Water Tank™	\$2,875	\$2,300	\$25
IHTF-D-BSS	Ideal Hot & Cold Tap in PVD Satin Black Stainless Steel, Ideal Digital Hot Water Tank™ and Water Filtration System	\$2,895	\$2,316	\$25
IHTF-D-GSS	Ideal Hot & Cold Tap in PVD Gun Metal Gray™ Stainless Steel, Ideal Digital Hot Water Tank™ and Water Filtration System	\$2,895	\$2,316	\$25
IHTF-D-MSS	Ideal Hot & Cold Tap in Matte Stainless Steel, Ideal Digital Hot Water Tank™ and Water Filtration System	\$2,495	\$1,996	\$25
IHTF-D-PSS	Ideal Hot & Cold Tap in Polished Stainless Steel, Ideal Digital Hot Water Tank™ and Water Filtration System	\$2,495	\$1,996	\$25
IHTF-D-RSS	Ideal Hot & Cold Tap in PVD Polished Rose Gold Stainless Steel, Ideal Digital Hot Water Tank™ and Water Filtration System	\$3,095	\$2,476	\$25
IHTF-D-YSS	Ideal Hot & Cold Tap in PVD Brushed Gold Stainless Steel, Ideal Digital Hot Water Tank™ and Water Filtration System	\$3,095	\$2,476	\$25
IPT-D-BSS	Ideal Pot Filler Tap in PVD Satin Black Stainless Steel	\$2,375	\$1,900	\$25
IPT-D-GSS	Ideal Pot Filler Tap in PVD Gun Metal Gray™ Stainless Steel	\$2,375	\$1,900	\$25
IPT-D-MSS	Ideal Pot Filler Tap in Matte Stainless Steel	\$1,775	\$1,420	\$25
IPT-D-PSS	Ideal Pot Filler Tap in Polished Stainless Steel	\$1,775	\$1,420	\$25
IPT-D-RSS	Ideal Pot Filler Tap in PVD Polished Rose Gold Stainless Steel	\$2,675	\$2,140	\$25
IPT-D-YSS	Ideal Pot Filler Tap in PVD Brushed Gold Stainless Steel	\$2,675	\$2,140	\$25
IPTF-D-BSS	Ideal Pot Filler Tap in PVD Satin Black Stainless Steel and Water Filtration System	\$2,595	\$2,076	\$25
IPTF-D-GSS	Ideal Pot Filler Tap in PVD Gun Metal Gray™ Stainless Steel and Water Filtration System	\$2,595	\$2,076	\$25
IPTF-D-MSS	Ideal Pot Filler Tap in Matte Stainless Steel and Water Filtration System	\$1,995	\$1,596	\$25
IPTF-D-PSS	Ideal Pot Filler Tap in Polished Stainless Steel and Water Filtration System	\$1,995	\$1,596	\$25
IPTF-D-RSS	Ideal Pot Filler Tap in PVD Polished Rose Gold Stainless Steel and Water Filtration System	\$2,895	\$2,316	\$25
IPTF-D-YSS	Ideal Pot Filler Tap in PVD Brushed Gold Stainless Steel and Water Filtration System	\$2,895	\$2,316	\$25
IWF-79-HF	Water Filtration System High Flow 2.0gpm, 7900 Gallon Capacity, Fibercarbon Block <0.5 Micron	\$320	\$256	\$25

Product Index

Sorted by product category

Taps

Product code	Description	MSRP	UMRP	Freight
IWT-D-BSS-EF	Ideal Tap Eco Flow in PVD Satin Black Stainless Steel	\$3,175	\$2,540	\$25
IWT-D-BSS-HF	Ideal Tap High Flow in PVD Satin Black Stainless Steel	\$3,175	\$2,540	\$25
IWT-D-GSS-EF	Ideal Tap Eco Flow in PVD Gun Metal Gray™ Stainless Steel	\$3,175	\$2,540	\$25
IWT-D-GSS-HF	Ideal Tap High Flow in PVD Gun Metal Gray™ Stainless Steel	\$3,175	\$2,540	\$25
IWT-D-MSS-EF	Ideal Tap Eco Flow in Matte Stainless Steel	\$2,375	\$1,900	\$25
IWT-D-MSS-HF	Ideal Tap High Flow in Matte Stainless Steel	\$2,375	\$1,900	\$25
IWT-D-PSS-EF	Ideal Tap Eco Flow in Polished Stainless Steel	\$2,375	\$1,900	\$25
IWT-D-PSS-HF	Ideal Tap High Flow in Polished Stainless Steel	\$2,375	\$1,900	\$25
IWT-D-RSS-EF	Ideal Tap Eco Flow in PVD Polished Rose Gold Stainless Steel	\$3,475	\$2,780	\$25
IWT-D-RSS-HF	Ideal Tap High Flow in PVD Polished Rose Gold Stainless Steel	\$3,475	\$2,780	\$25
IWT-D-YSS-EF	Ideal Tap Eco Flow in PVD Brushed Gold Stainless Steel	\$3,475	\$2,780	\$25
IWT-D-YSS-HF	Ideal Tap High Flow in PVD Brushed Gold Stainless Steel	\$3,475	\$2,780	\$25
IWTF-D-BSS-EF	Ideal Tap Eco Flow in PVD Satin Black Stainless Steel and Water Filtration System	\$3,395	\$2,716	\$25
IWTF-D-BSS-HF	Ideal Tap High Flow in PVD Satin Black Stainless Steel and Water Filtration System	\$3,395	\$2,716	\$25
IWTF-D-GSS-EF	Ideal Tap Eco Flow in PVD Gun Metal Gray™ Stainless Steel and Water Filtration System	\$3,395	\$2,716	\$25
IWTF-D-GSS-HF	Ideal Tap High Flow in PVD Gun Metal Gray™ Stainless Steel and Water Filtration System	\$3,395	\$2,716	\$25
IWTF-D-MSS-EF	Ideal Tap Eco Flow in Matte Stainless Steel and Water Filtration System	\$2,595	\$2,076	\$25
IWTF-D-MSS-HF	Ideal Tap High Flow in Matte Stainless Steel and Water Filtration System	\$2,595	\$2,076	\$25
IWTF-D-PSS-EF	Ideal Tap Eco Flow in Polished Stainless Steel and Water Filtration System	\$2,595	\$2,076	\$25
IWTF-D-PSS-HF	Ideal Tap HighFlow in Polished Stainless Steel and Water Filtration System	\$2,595	\$2,076	\$25
IWTF-D-RSS-EF	Ideal Tap Eco Flow in PVD Polished Rose Gold Stainless Steel and Water Filtration System	\$3,695	\$2,956	\$25
IWTF-D-RSS-HF	Ideal Tap High Flow in PVD Polished Rose Gold Stainless Steel and Water Filtration System	\$3,695	\$2,956	\$25
IWTF-D-YSS-EF	Ideal Tap Eco Flow in PVD Brushed Gold Stainless Steel and Water Filtration System	\$3,695	\$2,956	\$25
IWTF-D-YSS-HF	Ideal Tap High Flow in PVD Brushed Gold Stainless Steel and Water Filtration System	\$3,695	\$2,956	\$25
PFT-RO-SS	Ideal Pot Filler Tap Required Rough-in Part	\$300	\$240	\$25

Tap Accessories

Product code	Description	MSRP	UMRP	Freight
IAG-1-BSS	Ideal Air Gap in PVD Satin Black Stainless Steel	\$410	\$328	\$15
IAG-1-GSS	Ideal Air Gap in PVD Gun Metal Gray™ Stainless Steel	\$410	\$328	\$15
IAG-1-MSS	Ideal Air Gap in Matte Stainless Steel	\$330	\$264	\$15
IAG-1-PSS	Ideal Air Gap in Polished Stainless Steel	\$330	\$264	\$15
IAG-1-RSS	Ideal Air Gap in PVD Polished Rose Gold Stainless Steel	\$450	\$360	\$15
IAG-1-YSS	Ideal Air Gap in PVD Brushed Gold Stainless Steel	\$450	\$360	\$15
IDS-1-BSS	Ideal Deck Switch in PVD Satin Black Stainless Steel	\$595	\$476	\$15
IDS-1-GSS	Ideal Deck Switch in PVD Gun Metal Gray™ Stainless Steel	\$595	\$476	\$15
IDS-1-MSS	Ideal Deck Switch in Matte Stainless Steel	\$495	\$396	\$15
IDS-1-PSS	Ideal Deck Switch in Polished Stainless Steel	\$495	\$396	\$15
IDS-1-RSS	Ideal Deck Switch in PVD Polished Rose Gold Stainless Steel	\$650	\$520	\$15
IDS-1-YSS	Ideal Deck Switch in PVD Brushed Gold Stainless Steel	\$650	\$520	\$15
IHC-1-BSS	Ideal Hole Cover in PVD Satin Black Stainless Steel	\$230	\$184	\$15
IHC-1-GSS	Ideal Hole Cover in PVD Gun Metal Gray™ Stainless Steel	\$230	\$184	\$15
IHC-1-MSS	Ideal Hole Cover in Matte Stainless Steel	\$180	\$144	\$15
IHC-1-PSS	Ideal Hole Cover in Polished Stainless Steel	\$180	\$144	\$15
IHC-1-RSS	Ideal Hole Cover in PVD Polished Rose Gold Stainless Steel	\$260	\$208	\$15
IHC-1-YSS	Ideal Hole Cover in PVD Brushed Gold Stainless Steel	\$260	\$208	\$15
ISD-1-BSS	Ideal Soap Dispenser in PVD Satin Black Stainless Steel	\$895	\$716	\$15
ISD-1-GSS	Ideal Soap Dispenser in PVD Gun Metal Gray™ Finish Stainless Steel	\$895	\$716	\$15
ISD-1-MSS	Ideal Soap Dispenser in Matte Finish Stainless Steel	\$695	\$556	\$15
ISD-1-PSS	Ideal Soap Dispenser in Polished Stainless Steel	\$695	\$556	\$15
ISD-1-RSS	Ideal Soap Dispenser in PVD Polished Rose Gold Stainless Steel	\$995	\$796	\$15
ISD-1-YSS	Ideal Soap Dispenser in PVD Brushed Gold Stainless Steel	\$995	\$796	\$15

Water Filtration System

Product code	Description	MSRP	UMRP	Freight
IWF-79-HF	Water Filtration System High Flow 2.0gpm, 7900 Gallon Capacity, Fibercarbon Block <0.5 Micron	\$320	\$256	\$25
RFC-79-HF	Replacement Cartridge for Water Filtration System	\$195	\$156	\$25

Replacement Parts

Product code	Description	MSRP	UMRP	Freight
B1-11-0-ADA-ST	ADA Mixing Bowl 11 3/4" 5-qt Only in Stainless Steel	\$38	\$34	N/C
B1-11-0-ST	Mixing Bowl 11" 7.2-qt Only with Lid and Non-slip Bottom in Stainless Steel	\$38	\$34	N/C
B2-15-0-ST	Large Serving Bowl 14-7/8" x 5-1/2" in Stainless Steel	\$75	\$68	\$10
B4-04-0-SS	Bowl 4" Only for Garnish Board in Stainless Steel	\$29	\$26	N/C
C1-11-0-ST	Colander 11" 7.2-qt. with Soft Non-slip Handles in Stainless Steel	\$38	\$34	N/C
C1-11-0-ADA-ST	ADA Colander 11" 5.5-qt in Stainless Steel	\$38	\$34	N/C
COVER-SS	Cover for D1 and D2 Deep and Shallow Container in Stainless Steel	\$6	\$5	N/C
D-IHWT-SS	Ideal Digital Hot Water Tank™ Only	\$675	\$608	\$15
D1-04-0-SS	Deep Container Only for Condiment Serving Boards 6-3/4" x 4-1/4" x 4" in Stainless Steel	\$22	\$20	N/C
D2-04-0-SS	Shallow Container Only for Condiment Serving Boards 6-3/4" x 4-1/4" x 2-1/2" in Stainless Steel	\$17	\$15	N/C
DC-03-R-SS	HydroStation™ Round Elevated Drain Cover in Stainless Steel	\$60	\$54	\$15
DC-05-R-SS	Round Elevated Drain Cover in Stainless Steel	\$65	\$59	\$15
HFO-D-BSS	Ideal Hot & Cold Tap in PVD Satin Black Stainless Steel	\$2,000	\$1,800	\$25
HFO-D-GSS	Ideal Hot & Cold Tap in PVD Gun Metal Gray™ Stainless Steel	\$2,000	\$1,800	\$25
HFO-D-MSS	Ideal Hot & Cold Tap in Matte Stainless Steel	\$1,600	\$1,440	\$25

Product Index

Sorted by product category

Replacement Parts

Product code	Description	MSRP	UMRP	Freight
HFO-D-PSS	Ideal Hot & Cold Tap in Polished Stainless Steel	\$1,600	\$1,440	\$25
HFO-D-RSS	Ideal Hot & Cold Tap in PVD Polished Rose Gold Stainless Steel	\$2,200	\$1,980	\$25
HFO-D-YSS	Ideal Hot & Cold Tap in PVD Brushed Gold Stainless Steel	\$2,200	\$1,980	\$25
MG-05-0-SS	Mini Grate Only for Utensil Caddy 4-1/2" x 4-1/2" in Stainless Steel	\$75	\$68	\$10
P1-12-L-ADA-BA	Lower Tier ADA Platform Only 12-1/4" x 17" for ADA Mixing Bowl 11" and Colander 11" in Natural Golden Bamboo	\$200	\$180	\$25
P1-12-L-BA	Lower Tier Platform Only 12-1/4" x 17" for Mixing Bowl 11" and Colander 11" in Natural Golden Bamboo	\$200	\$180	\$25
P1-12-L-ADA-GR	Lower Tier ADA Platform Only 12-1/4" x 17" for ADA Mixing Bowl 11" and Colander 11" in Exclusive Gray Resin	\$150	\$135	\$25
P1-12-L-GR	Lower Tier Platform Only 12-1/4" x 17" for Mixing Bowl 11" and Colander 11" in Exclusive Gray Resin	\$150	\$135	\$25
P1-12-L-ADA-GT	Lower Tier ADA Platform Only 12-1/4" x 17" for ADA Mixing Bowl 11" and Colander 11" in Graphite Wood Composite	\$200	\$180	\$25
P1-12-L-GT	Lower Tier Platform Only 12-1/4" x 17" for Mixing Bowl 11" and Colander 11" in Graphite Wood Composite	\$200	\$180	\$25
P1-12-L-ADA-WA	Lower Tier ADA Platform Only 12-1/4" x 17" for ADA Mixing Bowl 11" and Colander 11" in American Black Walnut	\$275	\$248	\$25
P1-12-L-WA	Lower Tier Platform Only 12-1/4" x 17" for ADA Mixing Bowl 11" and Colander 11" in American Black Walnut	\$275	\$248	\$25
P1-12-L-ADA-WH	Lower Tier ADA Platform Only 12-1/4" x 17" for ADA Mixing Bowl 11" and Colander 11" in Designer White Resin	\$150	\$135	\$25
P1-12-L-WH	Lower Tier Platform Only 12-1/4" x 17" for ADA Mixing Bowl 11" and Colander 11" in Designer White Resin	\$150	\$135	\$25
P2-17-D-ADA-BA	Dual Tier ADA Platform Only 17" x 18" for ADA Mixing Bowl 11" and Colander 11" in Natural Golden Bamboo	\$225	\$203	\$25
P2-17-D-BA	Dual Tier ADA Platform Only 17" x 18" for ADA Mixing Bowl 11" and Colander 11" in Natural Golden Bamboo	\$225	\$203	\$25
P2-17-D-ADA-GR	Dual Tier ADA Platform Only 17" x 18" for ADA Mixing Bowl 11" and Colander 11" in Exclusive Gray Resin	\$175	\$158	\$25
P2-17-D-GR	Dual Tier ADA Platform Only 17" x 18" for ADA Mixing Bowl 11" and Colander 11" in Exclusive Gray Resin	\$175	\$158	\$25
P2-17-D-ADA-GT	Dual Tier ADA Platform Only 17" x 18" for ADA Mixing Bowl 11" and Colander 11" in Graphite Wood Composite	\$225	\$203	\$25
P2-17-D-GT	Dual Tier Platform Only 17" x 18" for ADA Mixing Bowl 11" and Colander 11" in Graphite Wood Composite	\$225	\$203	\$25
P2-17-D-ADA-WA	Dual Tier ADA Platform Only 17" x 18" for ADA Mixing Bowl 11" and Colander 11" in American Black Walnut	\$300	\$270	\$25
P2-17-D-WA	Dual Tier Platform Only 17" x 18" for ADA Mixing Bowl 11" and Colander 11" in American Black Walnut	\$300	\$270	\$25
P2-17-D-ADA-WH	Dual Tier ADA Platform Only 17" x 18" for ADA Mixing Bowl 11" and Colander 11" in Designer White Resin	\$175	\$158	\$25
P2-17-D-WH	Dual Tier Platform Only 17" x 18" for ADA Mixing Bowl 11" and Colander 11" in Designer White Resin	\$175	\$158	\$25
P3-17-D-BA	Dual Tier Platform Only for Wash & Serve Set 17" x 18" in Natural Golden Bamboo	\$225	\$203	\$25
P3-17-D-GR	Dual Tier Platform Only for Wash & Serve Set 17" x 18" in Exclusive Gray Resin	\$150	\$135	\$25
P3-17-D-GT	Dual Tier Platform Only for Wash & Serve Set 17" x 18" in Graphite Wood Composite	\$225	\$203	\$25
P3-17-D-WA	Dual Tier Platform Only for Wash & Serve Set 17" x 18" in American Black Walnut	\$300	\$270	\$25
P3-17-D-WH	Dual Tier Platform Only for Wash & Serve Set 17" x 18" in Designer White Resin	\$150	\$135	\$25
P4-17-C-BA	Lower Tier Corner Platform Only for Wash & Serve Set 17-1/2" x 17-1/2" in Natural Golden Bamboo	\$250	\$225	\$25
P4-17-C-GR	Lower Tier Corner Platform Only for Wash & Serve Set 17-1/2" x 17-1/2" in Exclusive Gray Resin	\$175	\$158	\$25
P4-17-C-GT	Lower Tier Corner Platform Only for Wash & Serve Set 17-1/2" x 17-1/2" in Graphite Wood Composite	\$250	\$225	\$25
P4-17-C-WA	Lower Tier Corner Platform Only for Wash & Serve Set 17-1/2" x 17-1/2" in American Black Walnut	\$325	\$293	\$25
P4-17-C-WH	Lower Tier Corner Platform Only for Wash & Serve Set 17-1/2" x 17-1/2" in Designer White Resin	\$175	\$158	\$25
P5-7X7-BA	HydroPlate Platform Only 7" x 7" in Natural Golden Bamboo	\$100	\$90	\$25
P5-7X7-GR	HydroPlate Platform Only 7" x 7" in Exclusive Gray Resin	\$75	\$68	\$25
P5-7X7-GT	HydroPlate Platform Only 7" x 7" in Graphite Wood Composite	\$100	\$90	\$25
P5-7X7-WA	HydroPlate Platform Only 7" x 7" in American Black Walnut	\$125	\$113	\$25
P5-7X7-WH	HydroPlate Platform Only 7" x 7" in Designer White Resin	\$75	\$68	\$25
PC-04-0-SS	Cylinder Only 4-1/2" for Utensil Caddy in Stainless Steel	\$10	\$9	N/C
P-DRN-CIT	Pop-up Basin Strainer & Stopper in Citrine	\$25	\$23	N/C
PFT-RO-SS	Ideal Pot Filler Tap Required Rough-in Part	\$300	\$240	\$25
RFC-79-HF	Replacement Cartridge for Water Filtration System	\$195	\$156	\$25
S1-06-U-BA	Upper Tier Garnish Board Platform Only 6" x 18" in Natural Golden Bamboo	\$185	\$167	\$25
S1-06-U-GR	Upper Tier Garnish Board Platform Only 6" x 18" in Exclusive Gray Resin	\$110	\$99	\$25
S1-06-U-GT	Upper Tier Garnish Board Platform Only 6" x 18" in Graphite Wood Composite	\$185	\$167	\$25
S1-06-U-WA	Upper Tier Garnish Board Platform Only 6" x 18" in American Black Walnut	\$235	\$212	\$25
S1-06-U-WH	Upper Tier Garnish Board Platform Only 6" x 18" in Designer White Resin	\$110	\$99	\$25
S2-17-D-BA	Dual Tier Serving Board Platform Only 17" x 18" in Natural Golden Bamboo	\$197	\$177	\$25
S2-17-D-GR	Dual Tier Serving Board Platform Only 17" x 18" in Exclusive Gray Resin	\$122	\$110	\$25
S2-17-D-GT	Dual Tier Serving Board Platform Only 17" x 18" in Graphite Wood Composite	\$197	\$177	\$25
S2-17-D-WA	Dual Tier Serving Board Platform Only 17" x 18" in American Black Walnut	\$272	\$245	\$25
S2-17-D-WH	Dual Tier Serving Board Platform Only 17" x 18" in Designer White Resin	\$122	\$110	\$25
S3-09-U-BA	Upper Tier Condiment Serving Board Platform Only 9" x 18" in Natural Golden Bamboo	\$176	\$158	\$25
S3-09-U-GR	Upper Tier Condiment Serving Board Platform Only 9" x 18" in Exclusive Gray Resin	\$126	\$113	\$25
S3-09-U-GT	Upper Tier Condiment Serving Board Platform Only 9" x 18" in Graphite Wood Composite	\$176	\$158	\$25
S3-09-U-WA	Upper Tier Condiment Serving Board Platform Only 9" x 18" in American Black Walnut	\$226	\$203	\$25
S3-09-U-WH	Upper Tier Condiment Serving Board Platform Only 9" x 18" in Designer White Resin	\$126	\$113	\$25
S4-06-U-BA	Upper Tier Utensil Caddy Board Platform Only 6" x 18" in Natural Golden Bamboo	\$130	\$117	\$25
S4-06-U-GR	Upper Tier Utensil Caddy Board Platform Only 6" x 18" in Exclusive Gray Resin	\$80	\$72	\$25
S4-06-U-GT	Upper Tier Utensil Caddy Board Platform Only 6" x 18" in Graphite Wood Composite	\$130	\$117	\$25
S4-06-U-WA	Upper Tier Utensil Caddy Board Platform Only 6" x 18" in American Black Walnut	\$180	\$162	\$25
S4-06-U-WH	Upper Tier Utensil Caddy Board Platform Only 6" x 18" in Designer White Resin	\$80	\$72	\$25
W1-15-0-SS	Wash Basin 15-1/2" x 6-5/8" in Stainless Steel	\$200	\$180	\$25
WW-04-0-SS	Wedge Wire Grate Only for HydroPlate 4" x 4" in Stainless Steel	\$150	\$135	\$10

citrine.

Product code	Description	MSRP	UMRP	Freight
CIT-04-WD-B	citrine. Wood Finishing Balm 4 oz. Individual Tin	\$22	\$20	\$10
CIT-04-WD-B-CS	citrine. Wood Finishing Balm 4 oz. Case of 12 Tins	\$250	\$225	\$25
CIT-09-SS-C	citrine. Stainless Steel Clean + Polish 9 oz. Individual Bottle	\$33	\$30	\$10
CIT-09-SS-C-CS	citrine. Stainless Steel Clean + Polish 9 oz. Case of 12 Bottles	\$375	\$338	\$25
CIT-09-WD-C	citrine. Wood Condition + Protect 9 oz. Individual Bottle	\$25	\$23	\$10
CIT-09-WD-C-CS	citrine. Wood Condition + Protect 9 oz. Case of 12 Bottles	\$300	\$270	\$25

Product Index

Sorted by product code

Product code	Description	MSRP	UMRP	Freight
A-DRN-MSS	Automatic Strainer Basket 3-1/2" with Remote Pop-up Knob and 27-1/2" Cable in Matte Stainless Steel	\$220	\$198	\$15
A-DRN-PSS	Automatic Strainer Basket 3-1/2" with Remote Pop-up Knob and 27-1/2" Cable in Polished Stainless Steel	\$240	\$216	\$15
B1-11-0-ADA-ST	ADA Mixing Bowl 11-3/4" 5-qt Only in Stainless Steel	\$38	\$34	N/C
B1-11-0-ST	Mixing Bowl 11" 7.2-qt Only with Lid and Non-slip Bottom in Stainless Steel	\$38	\$34	N/C
B2-15-0-ST	Large Serving Bowl 14-7/8" x 5-1/2" in Stainless Steel	\$75	\$68	\$10
B4-04-0-SS	Bowl 4" Only for Garnish Board in Stainless Steel	\$29	\$26	N/C
BC-12-L-BA	Mixing Bowl 11" and Colander 11" in Stainless Steel, Lower Tier Platform 12-1/4" x 17" Set in Natural Golden Bamboo	\$275	\$248	\$25
BC-12-L-GR	Mixing Bowl 11" and Colander 11" in Stainless Steel, Lower Tier Platform 12-1/4" x 17" Set in Exclusive Gray Resin	\$225	\$203	\$25
BC-12-L-GT	Mixing Bowl 11" and Colander 11" in Stainless Steel, Lower Tier Platform 12-1/4" x 17" Set in Graphite Wood Composite	\$275	\$248	\$25
BC-12-L-WA	Mixing Bowl 11" and Colander 11" in Stainless Steel, Lower Tier Platform 12-1/4" x 17" Set in American Black Walnut	\$350	\$315	\$25
BC-12-L-WH	Mixing Bowl 11" and Colander 11" in Stainless Steel, Lower Tier Platform 12-1/4" x 17" Set in Designer White Resin	\$225	\$203	\$25
BC-17-D-BA	Mixing Bowl 11" and Colander 11" in Stainless Steel, Dual Tier Platform 17" x 18" Set in Natural Golden Bamboo	\$300	\$270	\$25
BC-17-D-GR	Mixing Bowl 11" and Colander 11" in Stainless Steel, Dual Tier Platform 17" x 18" Set in Exclusive Gray Resin	\$250	\$225	\$25
BC-17-D-GT	Mixing Bowl 11" and Colander 11" in Stainless Steel, Dual Tier Platform 17" x 18" Set in Graphite Wood Composite	\$300	\$270	\$25
BC-17-D-WA	Mixing Bowl 11" and Colander 11" in Stainless Steel, Dual Tier Platform 17" x 18" Set in American Black Walnut	\$375	\$338	\$25
BC-17-D-WH	Mixing Bowl 11" and Colander 11" in Stainless Steel, Dual Tier Platform 17" x 18" Set in Designer White Resin	\$250	\$225	\$25
BG-05-N-SS	Bottom Grate Section 5-1/2" x 15-1/2" in Stainless Steel	\$200	\$180	\$25
BG-11-N-SS	Bottom Grate Section 11-1/2" x 15-1/2" for IWS 4S, 4X4C, 6S, IWA 4S, 4X4C, IWW 6D in Stainless Steel	\$250	\$225	\$25
BG-13-C-SS	Bottom Grate Section 13-1/2" x 15-1/2" for IBS 18C in Stainless Steel	\$250	\$225	\$25
BG-18-C-1-SS	Bottom Grate Single Section Set for IBS 18C in Stainless Steel	\$250	\$225	\$25
BG-2-C-1-SS	Bottom Grate Single Section Set for IWS 2C, IWA 2C, IBS 2C in Stainless Steel	\$300	\$270	\$25
BG-20-C-SS	Bottom Grate Section 20" x 15-1/2" for IWS 2C, IWA 2C, 4D, IWW 4D, 5D, 6D, 7D, IBS 2C in Stainless Steel	\$300	\$270	\$25
BG-23-N-SS	Bottom Grate Section 23-1/2" x 15-1/2" for IWS 5S, 6S, 7S, IWW 7D in Stainless Steel	\$300	\$270	\$25
BG-25-N-SS	Bottom Grate Section 25-1/2" x 15-1/2" for IWS 3X4C, 4X3C, 4X4C, IWA 3X4C, 4X3C, 4X4C in Stainless Steel	\$325	\$293	\$25
BG-25-S-SS	Bottom Grate Section 25-1/2" x 15-1/2" for IWS 30S, IWA 30S in Stainless Steel	\$325	\$293	\$25
BG-29-S-SS	Bottom Grate Section 29" x 15-1/2" for IWS 3X4C, 4X3C, 4X4C, IWA 3X4C, 4X3C, 4X4C in Stainless Steel	\$350	\$315	\$25
BG-30-S-1-SS	Bottom Grate Single Section Set for IWS 30S, IWA 30S in Stainless Steel	\$325	\$293	\$25
BG-3-S-1-SS	Bottom Grate Single Section Set for IWS 3S, IWA 3S in Stainless Steel	\$350	\$315	\$25
BG-31-S-SS	Bottom Grate Section 31-1/2" x 15-1/2" for IWS 3S, 4S, 5S, 6S, 7S, IWA 3S, 4S, IWW 5D, 6D, 7D in Stainless Steel	\$350	\$315	\$25
BG-4-D-2-SS	Bottom Grate Two Section Set for IWA 4D, IWW 4D in Stainless Steel	\$600	\$540	\$35
BG-4-S-2-SS	Bottom Grate Two Section Set for IWS 4S, IWA 4S in Stainless Steel	\$600	\$540	\$35
BG-4X3-C-2-SS	Bottom Grate Two Section Set for IWS 3X4C, 4X3C, IWA 3X4C, 4X3C in Stainless Steel	\$675	\$608	\$35
BG-4X4-C-3-SS	Bottom Grate Three Section Set for IWS 4X4C, IWA 4X4C in Stainless Steel	\$925	\$833	\$35
BG-5-D-2-SS	Bottom Grate Two Section Set for IWW 5D in Stainless Steel	\$650	\$585	\$35
BG-5-S-2-SS	Bottom Grate Two Section Set for IWS 5S in Stainless Steel	\$650	\$585	\$35
BG-6-D-3-SS	Bottom Grate Three Section Set for IWW 6D in Stainless Steel	\$900	\$810	\$35
BG-6-S-3-SS	Bottom Grate Three Section Set for IWS 6S in Stainless Steel	\$900	\$810	\$35
BG-7-D-3-SS	Bottom Grate Three Section Set for IWW 7D in Stainless Steel	\$950	\$855	\$35
BG-7-S-3-SS	Bottom Grate Three Section Set for IWS 7S in Stainless Steel	\$950	\$855	\$35
BKT-3T-BA	Bar Kit including Three Tools in Natural Golden Bamboo	\$700	\$630	\$45
BKT-3T-GR	Bar Kit including Three Tools in Exclusive Gray Resin	\$500	\$450	\$45
BKT-3T-GT	Bar Kit including Three Tools in Graphite Wood Composite	\$700	\$630	\$45
BKT-3T-WA	Bar Kit including Three Tools in American Black Walnut	\$900	\$810	\$45
BKT-3T-WH	Bar Kit including Three Tools in Designer White Resin	\$500	\$450	\$45
C1-11-0-ADA-ST	ADA Colander 11" 5.5-qt in Stainless Steel	\$38	\$34	N/C
C1-11-0-ST	Colander 11" 7.2-qt. with Soft Non-slip Handles in Stainless Steel	\$38	\$34	N/C
CB-12-U-BA	Upper Tier Cutting Board 12-1/4" x 18" with Juice Groove on one side in Natural Golden Bamboo	\$250	\$225	\$25
CB-12-U-GR	Upper Tier Cutting Board 12-1/4" x 18" with Juice Groove on one side in Exclusive Gray Resin	\$175	\$158	\$25
CB-12-U-GT	Upper Tier Cutting Board 12-1/4" x 18" with Juice Groove on one side in Graphite Wood Composite	\$250	\$225	\$25
CB-12-U-WA	Upper Tier Cutting Board 12-1/4" x 18" with Juice Groove on one side in American Black Walnut	\$350	\$315	\$25
CB-12-U-WH	Upper Tier Cutting Board 12-1/4" x 18" with Juice Groove on one side in Designer White Resin	\$175	\$158	\$25
CB-17-D-BA	Dual Tier Cutting Board 17" x 18" with Juice Groove on one side in Natural Golden Bamboo	\$275	\$248	\$25
CB-17-D-GR	Dual Tier Cutting Board 17" x 18" with Juice Groove on one side in Exclusive Gray Resin	\$200	\$180	\$25
CB-17-D-GT	Dual Tier Cutting Board 17" x 18" with Juice Groove on one side in Graphite Wood Composite	\$275	\$248	\$25
CB-17-D-WA	Dual Tier Cutting Board 17" x 18" with Juice Groove on one side in American Black Walnut	\$375	\$338	\$25
CB-17-D-WH	Dual Tier Cutting Board 17" x 18" with Juice Groove on one side in Designer White Resin	\$200	\$180	\$25
CB-18-C-BA	Upper Tier Corner Cutting Board 18-1/4" x 18-1/4" with Juice Groove on one side in Natural Golden Bamboo	\$300	\$270	\$25
CB-18-C-GR	Upper Tier Corner Cutting Board 18-1/4" x 18-1/4" with Juice Groove on one side in Exclusive Gray Resin	\$225	\$203	\$25
CB-18-C-GT	Upper Tier Corner Cutting Board 18-1/4" x 18-1/4" with Juice Groove on one side in Graphite Wood Composite	\$300	\$270	\$25
CB-18-C-WA	Upper Tier Corner Cutting Board 18-1/4" x 18-1/4" with Juice Groove on one side in American Black Walnut	\$400	\$360	\$25
CB-18-C-WH	Upper Tier Corner Cutting Board 18-1/4" x 18-1/4" with Juice Groove on one side in Designer White Resin	\$225	\$203	\$25
CH-12-U-BA	Upper Tier 2" thick Chef's Block 12-1/4" x 18" x 2" with Juice Groove on one side in Natural Golden Bamboo	\$375	\$338	\$25
CH-12-U-WA	Upper Tier 2" thick Chef's Block 12-1/4" x 18" x 2" with Juice Groove on one side in American Black Walnut	\$525	\$473	\$25
CH-17-D-BA	Dual Tier 2" thick Chef's Block 17" x 18" x 2" with Juice Groove on one side in Natural Golden Bamboo	\$450	\$405	\$25
CH-17-D-WA	Dual Tier 2" thick Chef's Block 17" x 18" x 2" with Juice Groove on one side in American Black Walnut	\$600	\$540	\$25
CH-18-C-BA	Upper Tier 2" thick Corner Chef's Block 18-1/4" x 18-1/4" x 2" with Juice Groove on one side in Natural Golden Bamboo	\$525	\$473	\$25
CH-18-C-WA	Upper Tier 2" thick Corner Chef's Block 18-1/4" x 18-1/4" x 2" with Juice Groove on one side in American Black Walnut	\$675	\$608	\$25
CIT-04-WD-B	citrine. Wood Finishing Balm 4 oz. Individual Tin	\$22	\$20	\$10
CIT-04-WD-B-CS	citrine. Wood Finishing Balm 4 oz. Case of 12 Tins	\$250	\$225	\$25
CIT-09-SS-C	citrine. Stainless Steel Clean + Polish 9 oz. Individual Bottle	\$33	\$30	\$10
CIT-09-SS-C-CS	citrine. Stainless Steel Clean + Polish 9 oz. Case of 12 Bottles	\$375	\$338	\$25
CIT-09-WD-C	citrine. Wood Condition + Protect 9 oz. Individual Bottle	\$25	\$23	\$10
CIT-09-WD-C-CS	citrine. Wood Condition + Protect 9 oz. Case of 12 Bottles	\$300	\$270	\$25
CKT-12-ADA-BA	Small ADA Culinary Kit including Five Tools in Natural Golden Bamboo	\$1,200	\$1,080	\$45
CKT-12-BA	Small Culinary Kit including Five Tools in Natural Golden Bamboo	\$1,200	\$1,080	\$45
CKT-12-ADA-GR	Small ADA Culinary Kit including Five Tools in Exclusive Gray Resin	\$900	\$810	\$45

Product Index

Sorted by product code

Product code	Description	MSRP	UMRP	Freight
CKT-12-GR	Small ADA Culinary Kit including Five Tools in Exclusive Gray Resin	\$900	\$810	\$45
CKT-12-ADA-GT	Small ADA Culinary Kit including Five Tools in Graphite Wood Composite	\$1,200	\$1,080	\$45
CKT-12-GT	Small Culinary Kit including Five Tools in Graphite Wood Composite	\$1,200	\$1,080	\$45
CKT-12-ADA-WA	Small ADA Culinary Kit including Five Tools in American Black Walnut	\$1,600	\$1,440	\$45
CKT-12-WA	Small ADA Culinary Kit including Five Tools in American Black Walnut	\$1,600	\$1,440	\$45
CKT-12-ADA-WH	Small ADA Culinary Kit including Five Tools in Designer White Resin	\$900	\$810	\$45
CKT-12-WH	Small Culinary Kit including Five Tools in Designer White Resin	\$900	\$810	\$45
CKT-17-ADA-BA	Large ADA Culinary Kit including Eight Tools in Natural Golden Bamboo	\$1,700	\$1,530	\$45
CKT-17-BA	Large ADA Culinary Kit including Eight Tools in Natural Golden Bamboo	\$1,700	\$1,530	\$45
CKT-17-ADA-GR	Large ADA Culinary Kit including Eight Tools in Exclusive Gray Resin	\$1,300	\$1,170	\$45
CKT-17-GR	Large ADA Culinary Kit including Eight Tools in Exclusive Gray Resin	\$1,300	\$1,170	\$45
CKT-17-ADA-GT	Large ADA Culinary Kit including Eight Tools in Graphite Wood Composite	\$1,700	\$1,530	\$45
CKT-17-GT	Large ADA Culinary Kit including Eight Tools in Graphite Wood Composite	\$1,700	\$1,530	\$45
CKT-17-ADA-WA	Large ADA Culinary Kit including Eight Tools in American Black Walnut	\$2,200	\$1,980	\$45
CKT-17-WA	Large ADA Culinary Kit including Eight Tools in American Black Walnut	\$2,200	\$1,980	\$45
CKT-17-ADA-WH	Large ADA Culinary Kit including Eight Tools in Designer White Resin	\$1,300	\$1,170	\$45
CKT-17-WH	Large ADA Culinary Kit including Eight Tools in Designer White Resin	\$1,300	\$1,170	\$45
COVER-SS	Cover for D1 and D2 Deep and Shallow Container in Stainless Steel	\$6	\$5	N/C
D-IHWT-SS	Ideal Digital Hot Water Tank™ Only	\$675	\$540	\$15
D1-04-0-SS	Deep Container Only for Condiment Serving Boards 6-3/4" x 4-1/4" x 4" in Stainless Steel	\$22	\$20	N/C
D2-04-0-SS	Shallow Container Only for Condiment Serving Boards 6-3/4" x 4-1/4" x 2-1/2" in Stainless Steel	\$17	\$15	N/C
DC-03-R-SS	HydroStation™ Round Elevated Drain Cover in Stainless Steel	\$60	\$54	\$15
DC-05-R-SS	Round Elevated Drain Cover in Stainless Steel	\$65	\$59	\$15
DD-12-C-BA	DryDock. 12" Center Drain with Lower Tier Drying Rack in Natural Golden Bamboo	\$1,775	\$1,598	N/A
DD-12-C-GR	DryDock. 12" Center Drain with Lower Tier Drying Rack in Exclusive Gray Resin	\$1,725	\$1,553	N/A
DD-12-C-GT	DryDock. 12" Center Drain with Lower Tier Drying Rack in Graphite Wood Composite	\$1,775	\$1,598	N/A
DD-12-C-WA	DryDock. 12" Center Drain with Lower Tier Drying Rack in American Black Walnut	\$1,825	\$1,643	N/A
DD-12-C-WH	DryDock. 12" Center Drain with Lower Tier Drying Rack in Designer White Resin	\$1,725	\$1,553	N/A
DD-12-N-BA	DryDock. 12" Non-drain Side with Lower Tier Drying Rack in Natural Golden Bamboo	\$1,775	\$1,598	N/A
DD-12-N-GR	DryDock. 12" Non-drain Side with Lower Tier Drying Rack in Exclusive Gray Resin	\$1,725	\$1,553	N/A
DD-12-N-GT	DryDock. 12" Non-drain Side with Lower Tier Drying Rack in Graphite Wood Composite	\$1,775	\$1,598	N/A
DD-12-N-WA	DryDock. 12" Non-drain Side with Lower Tier Drying Rack in American Black Walnut	\$1,825	\$1,643	N/A
DD-12-N-WH	DryDock. 12" Non-drain Side with Lower Tier Drying Rack in Designer White Resin	\$1,725	\$1,553	N/A
DD-12-S-BA	DryDock. 12" Drain Side with Lower Tier Drying Rack in Natural Golden Bamboo	\$1,775	\$1,598	N/A
DD-12-S-GR	DryDock. 12" Drain Side with Lower Tier Drying Rack in Exclusive Gray Resin	\$1,725	\$1,553	N/A
DD-12-S-GT	DryDock. 12" Drain Side with Lower Tier Drying Rack in Graphite Wood Composite	\$1,775	\$1,598	N/A
DD-12-S-WA	DryDock. 12" Drain Side with Lower Tier Drying Rack in American Black Walnut	\$1,825	\$1,643	N/A
DD-12-S-WH	DryDock. 12" Drain Side with Lower Tier Drying Rack in Designer White Resin	\$1,725	\$1,553	N/A
DD-18-C-BA	DryDock. 18" Center Drain with Dual Tier Drying Rack in Natural Golden Bamboo	\$2,125	\$1,913	N/A
DD-18-C-GR	DryDock. 18" Center Drain with Dual Tier Drying Rack in Exclusive Gray Resin	\$2,050	\$1,845	N/A
DD-18-C-GT	DryDock. 18" Center Drain with Dual Tier Drying Rack in Graphite Wood Composite	\$2,125	\$1,913	N/A
DD-18-C-WA	DryDock. 18" Center Drain with Dual Tier Drying Rack in American Black Walnut	\$2,175	\$1,958	N/A
DD-18-C-WH	DryDock. 18" Center Drain with Dual Tier Drying Rack in Designer White Resin	\$2,050	\$1,845	N/A
DD-18-N-BA	DryDock. 18" Non-drain Side with Dual Tier Drying Rack in Natural Golden Bamboo	\$2,125	\$1,913	N/A
DD-18-N-GR	DryDock. 18" Non-drain Side with Dual Tier Drying Rack in Exclusive Gray Resin	\$2,050	\$1,845	N/A
DD-18-N-GT	DryDock. 18" Non-drain Side with Dual Tier Drying Rack in Graphite Wood Composite	\$2,125	\$1,913	N/A
DD-18-N-WA	DryDock. 18" Non-drain Side with Dual Tier Drying Rack in American Black Walnut	\$2,175	\$1,958	N/A
DD-18-N-WH	DryDock. 18" Non-drain Side with Dual Tier Drying Rack in Designer White Resin	\$2,050	\$1,845	N/A
DD-18-S-BA	DryDock. 18" Drain Side with Dual Tier Drying Rack in Natural Golden Bamboo	\$2,125	\$1,913	N/A
DD-18-S-GR	DryDock. 18" Drain Side with Dual Tier Drying Rack in Exclusive Gray Resin	\$2,050	\$1,845	N/A
DD-18-S-GT	DryDock. 18" Drain Side with Dual Tier Drying Rack in Graphite Wood Composite	\$2,125	\$1,913	N/A
DD-18-S-WA	DryDock. 18" Drain Side with Dual Tier Drying Rack in American Black Walnut	\$2,175	\$1,958	N/A
DD-18-S-WH	DryDock. 18" Drain Side with Dual Tier Drying Rack in Designer White Resin	\$2,050	\$1,845	N/A
DR-06-L-BA	Lower Tier Mini Drying Rack 6" x 17" in Natural Golden Bamboo	\$225	\$203	\$25
DR-06-L-GR	Lower Tier Mini Drying Rack 6" x 17" in Exclusive Gray Resin	\$175	\$158	\$25
DR-06-L-GT	Lower Tier Mini Drying Rack 6" x 17" in Graphite Wood Composite	\$225	\$203	\$25
DR-06-L-WA	Lower Tier Mini Drying Rack 6" x 17" in American Black Walnut	\$275	\$248	\$25
DR-06-L-WH	Lower Tier Mini Drying Rack 6" x 17" in Designer White Resin	\$175	\$158	\$25
DR-09-U-BA	Upper Tier Drying Rack 9-1/4" x 18" in Natural Golden Bamboo	\$275	\$248	\$25
DR-09-U-GR	Upper Tier Drying Rack 9-1/4" x 18" in Exclusive Gray Resin	\$225	\$203	\$25
DR-09-U-GT	Upper Tier Drying Rack 9-1/4" x 18" in Graphite Wood Composite	\$275	\$248	\$25
DR-09-U-WA	Upper Tier Drying Rack 9-1/4" x 18" in American Black Walnut	\$325	\$293	\$25
DR-09-U-WH	Upper Tier Drying Rack 9-1/4" x 18" in Designer White Resin	\$225	\$203	\$25
DR-12-L-BA	Lower Tier Drying Rack 12-1/4" x 17" in Natural Golden Bamboo	\$275	\$248	\$25
DR-12-L-GR	Lower Tier Drying Rack 12-1/4" x 17" in Exclusive Gray Resin	\$225	\$203	\$25
DR-12-L-GT	Lower Tier Drying Rack 12-1/4" x 17" in Graphite Wood Composite	\$275	\$248	\$25
DR-12-L-WA	Lower Tier Drying Rack 12-1/4" x 17" in American Black Walnut	\$325	\$293	\$25
DR-12-L-WH	Lower Tier Drying Rack 12-1/4" x 17" in Designer White Resin	\$225	\$203	\$25
DR-12-U-BA	Upper Tier Drying Rack 12-1/4" x 18" in Natural Golden Bamboo	\$275	\$248	\$25
DR-12-U-GR	Upper Tier Drying Rack 12-1/4" x 18" in Exclusive Gray Resin	\$225	\$203	\$25
DR-12-U-GT	Upper Tier Drying Rack 12-1/4" x 18" in Graphite Wood Composite	\$275	\$248	\$25
DR-12-U-WA	Upper Tier Drying Rack 12-1/4" x 18" in American Black Walnut	\$325	\$293	\$25
DR-12-U-WH	Upper Tier Drying Rack 12-1/4" x 18" in Designer White Resin	\$225	\$203	\$25
DR-17-D-BA	Dual Tier Drying Rack 17" x 18" in Natural Golden Bamboo	\$325	\$293	\$25
DR-17-D-GR	Dual Tier Drying Rack 17" x 18" in Exclusive Gray Resin	\$250	\$225	\$25
DR-17-D-GT	Dual Tier Drying Rack 17" x 18" in Graphite Wood Composite	\$325	\$293	\$25

Product Index

Sorted by product code

Product code	Description	MSRP	UMRP	Freight
DR-17-D-WA	Dual Tier Drying Rack 17" x 18" in American Black Walnut	\$375	\$338	\$25
DR-17-D-WH	Dual Tier Drying Rack 17" x 18" in Designer White Resin	\$250	\$225	\$25
DR-18-D-BA	Dual Tier Drying Rack 18" x 17" in Natural Golden Bamboo	\$325	\$293	\$25
DR-18-D-GR	Dual Tier Drying Rack 18" x 17" in Exclusive Gray Resin	\$250	\$225	\$25
DR-18-D-GT	Dual Tier Drying Rack 18" x 17" in Graphite Wood Composite	\$325	\$293	\$25
DR-18-D-WA	Dual Tier Drying Rack 18" x 17" in American Black Walnut	\$375	\$338	\$25
DR-18-D-WH	Dual Tier Drying Rack 18" x 17" in Designer White Resin	\$250	\$225	\$25
DS-12-C-SS	DryDock. 12" only - Center Drain	\$1,500	\$1,350	N/A
DS-12-N-SS	DryDock. 12" only - Non-drain Side	\$1,500	\$1,350	N/A
DS-12-S-SS	DryDock. 12" only - Drain Side	\$1,500	\$1,350	N/A
DS-18-C-SS	DryDock. 18" only - Center Drain	\$1,800	\$1,620	N/A
DS-18-N-SS	DryDock. 18" only - Non-drain Side	\$1,800	\$1,620	N/A
DS-18-S-SS	DryDock. 18" only - Drain Side	\$1,800	\$1,620	N/A
EKT-4T-BA	Entertainment Kit including Four Tools in Natural Golden Bamboo	\$1,050	\$945	\$45
EKT-4T-GR	Entertainment Kit including Four Tools in Exclusive Gray Resin	\$850	\$765	\$45
EKT-4T-GT	Entertainment Kit including Four Tools in Graphite Wood Composite	\$1,050	\$945	\$45
EKT-4T-WA	Entertainment Kit including Four Tools in American Black Walnut	\$1,250	\$1,125	\$45
EKT-4T-WH	Entertainment Kit including Four Tools in Designer White Resin	\$850	\$765	\$45
G-DRN-MSS	3-in-1 Garbage Disposal Flange with Strainer Basket 3-1/2" in Angel Finish Stainless Steel	\$110	\$99	\$15
H-DRN-MSS	HydroStation™ 2" Drain & Plate in Angel Finish Stainless Steel	\$55	\$50	\$15
HFO-D-BSS	Ideal Hot & Cold Tap in PVD Satin Black Stainless Steel	\$2,000	\$1,600	\$25
HFO-D-GSS	Ideal Hot & Cold Tap in PVD Gun Metal Gray™ Stainless Steel	\$2,000	\$1,600	\$25
HFO-D-MSS	Ideal Hot & Cold Tap in Matte Stainless Steel	\$1,600	\$1,280	\$25
HFO-D-PSS	Ideal Hot & Cold Tap in Polished Stainless Steel	\$1,600	\$1,280	\$25
HFO-D-RSS	Ideal Hot & Cold Tap in PVD Polished Rose Gold Stainless Steel	\$2,200	\$1,760	\$25
HFO-D-YSS	Ideal Hot & Cold Tap in PVD Brushed Gold Stainless Steel	\$2,200	\$1,760	\$25
HP-7X7-BA	HydroPlate 7" x 7" with Wedge Wire Grate 4" x 4" in Natural Golden Bamboo	\$250	\$225	\$25
HP-7X7-GR	HydroPlate 7" x 7" with Wedge Wire Grate 4" x 4" in Exclusive Gray Resin	\$225	\$203	\$25
HP-7X7-GT	HydroPlate 7" x 7" with Wedge Wire Grate 4" x 4" in Graphite Wood Composite	\$250	\$225	\$25
HP-7X7-WA	HydroPlate 7" x 7" with Wedge Wire Grate 4" x 4" in American Black Walnut	\$275	\$248	\$25
HP-7X7-WH	HydroPlate 7" x 7" with Wedge Wire Grate 4" x 4" in Designer White Resin	\$225	\$203	\$25
HS-13-U-AL	Upper Tier Half Sheet Pan 13" x 18" in Corrugated Aluminum	\$27	\$24	\$25
HSO-1-V-SS	Basin Portion of IHS in Angel Finish 316L Stainless Steel	\$1,000	\$900	\$30
HSO-1-V-TT-SS	Basin Portion of IHS TT in Angel Finish 316L Stainless Steel	\$1,250	\$1,125	\$30
IAG-1-BSS	Ideal Air Gap in PVD Satin Black Stainless Steel	\$410	\$328	\$15
IAG-1-GSS	Ideal Air Gap in PVD Gun Metal Gray™ Stainless Steel	\$410	\$328	\$15
IAG-1-MSS	Ideal Air Gap in Matte Stainless Steel	\$330	\$264	\$15
IAG-1-PSS	Ideal Air Gap in Polished Stainless Steel	\$330	\$264	\$15
IAG-1-RSS	Ideal Air Gap in PVD Polished Rose Gold Stainless Steel	\$450	\$360	\$15
IAG-1-YSS	Ideal Air Gap in PVD Brushed Gold Stainless Steel	\$450	\$360	\$15
IBS-18-C-BA	Ideal BarStation. 18 with Three Tool Bar Kit in Natural Golden Bamboo	\$2,495	\$2,246	\$99
IBS-18-C-GR	Ideal BarStation. 18 with Three Tool Bar Kit in Exclusive Gray Resin	\$2,295	\$2,066	\$99
IBS-18-C-GT	Ideal BarStation. 18 with Three Tool Bar Kit in Graphite Wood Composite	\$2,495	\$2,246	\$99
IBS-18-C-WA	Ideal BarStation. 18 with Three Tool Bar Kit in American Black Walnut	\$2,695	\$2,426	\$99
IBS-18-C-WH	Ideal BarStation. 18 with Three Tool Bar Kit in Designer White Resin	\$2,295	\$2,066	\$99
IBS-18-C-TT-BA	Ideal ThinTop™ BarStation. 18 with Three Tool Bar Kit in Natural Golden Bamboo	\$2,995	\$2,696	\$99
IBS-18-C-TT-GR	Ideal ThinTop™ BarStation. 18 with Three Tool Bar Kit in Exclusive Gray Resin	\$2,795	\$2,516	\$99
IBS-18-C-TT-GT	Ideal ThinTop™ BarStation. 18 with Three Tool Bar Kit in Graphite Wood Composite	\$2,995	\$2,696	\$99
IBS-18-C-TT-WA	Ideal ThinTop™ BarStation. 18 with Three Tool Bar Kit in American Black Walnut	\$3,195	\$2,876	\$99
IBS-18-C-TT-WH	Ideal ThinTop™ BarStation. 18 with Three Tool Bar Kit in Designer White Resin	\$2,795	\$2,516	\$99
IBS-2-C-BA	Ideal BarStation. 2 with Three Tool Bar Kit in Natural Golden Bamboo	\$2,795	\$2,516	\$99
IBS-2-C-GR	Ideal BarStation. 2 with Three Tool Bar Kit in Exclusive Gray Resin	\$2,595	\$2,336	\$99
IBS-2-C-GT	Ideal BarStation. 2 with Three Tool Bar Kit in Graphite Wood Composite	\$2,795	\$2,516	\$99
IBS-2-C-WA	Ideal BarStation. 2 with Three Tool Bar Kit in American Black Walnut	\$2,995	\$2,696	\$99
IBS-2-C-WH	Ideal BarStation. 2 with Three Tool Bar Kit in Designer White Resin	\$2,595	\$2,336	\$99
IBT-D-BSS-EF	Ideal BarTap. Eco Flow in PVD Satin Black Stainless Steel	\$3,175	\$2,540	\$25
IBT-D-BSS-HF	Ideal BarTap. High Flow in PVD Satin Black Stainless Steel	\$3,175	\$2,540	\$25
IBT-D-GSS-EF	Ideal BarTap. Eco Flow in PVD Gun Metal Gray™ Stainless Steel	\$3,175	\$2,540	\$25
IBT-D-GSS-HF	Ideal BarTap. High Flow in PVD Gun Metal Gray™ Stainless Steel	\$3,175	\$2,540	\$25
IBT-D-MSS-EF	Ideal BarTap. Eco Flow in Matte Stainless Steel	\$2,275	\$1,820	\$25
IBT-D-MSS-HF	Ideal BarTap. High Flow in Matte Stainless Steel	\$2,275	\$1,820	\$25
IBT-D-PSS-EF	Ideal BarTap. Eco Flow in Polished Stainless Steel	\$2,275	\$1,820	\$25
IBT-D-PSS-HF	Ideal BarTap. High Flow in Polished Stainless Steel	\$2,275	\$1,820	\$25
IBT-D-RSS-EF	Ideal BarTap. Eco Flow in PVD Polished Rose Gold Stainless Steel	\$3,375	\$2,700	\$25
IBT-D-RSS-HF	Ideal BarTap. High Flow in PVD Polished Rose Gold Stainless Steel	\$3,375	\$2,700	\$25
IBT-D-YSS-EF	Ideal BarTap. Eco Flow in PVD Brushed Gold Stainless Steel	\$3,375	\$2,700	\$25
IBT-D-YSS-HF	Ideal BarTap. High Flow in PVD Brushed Gold Stainless Steel	\$3,375	\$2,700	\$25
IBTF-D-BSS-EF	Ideal BarTap. Eco Flow in PVD Satin Black Stainless Steel and Water Filtration System	\$3,395	\$2,716	\$25
IBTF-D-BSS-HF	Ideal BarTap. High Flow in PVD Satin Black Stainless Steel and Water Filtration System	\$3,395	\$2,716	\$25
IBTF-D-GSS-EF	Ideal BarTap. Eco Flow in PVD Gun Metal Gray™ Stainless Steel and Water Filtration System	\$3,395	\$2,716	\$25
IBTF-D-GSS-HF	Ideal BarTap. High Flow in PVD Gun Metal Gray™ Stainless Steel and Water Filtration System	\$3,395	\$2,716	\$25
IBTF-D-MSS-EF	Ideal BarTap. Eco Flow in Matte Stainless Steel and Water Filtration System	\$2,495	\$1,996	\$25
IBTF-D-MSS-HF	Ideal BarTap. High Flow in Matte Stainless Steel and Water Filtration System	\$2,495	\$1,996	\$25
IBTF-D-PSS-EF	Ideal BarTap. Eco Flow in Polished Stainless Steel and Water Filtration System	\$2,495	\$1,996	\$25
IBTF-D-PSS-HF	Ideal BarTap. High Flow in Polished Stainless Steel and Water Filtration System	\$2,495	\$1,996	\$25
IBTF-D-RSS-EF	Ideal BarTap. Eco Flow in PVD Polished Rose Gold Stainless Steel and Water Filtration System	\$3,595	\$2,876	\$25

Product Index

Sorted by product code

Product code	Description	MSRP	UMRP	Freight
IBTF-D-RSS-HF	Ideal BarTap. High Flow in PVD Polished Rose Gold Stainless Steel and Water Filtration System	\$3,595	\$2,876	\$25
IBTF-D-YSS-EF	Ideal BarTap. Eco Flow in PVD Brushed Gold Stainless Steel and Water Filtration System	\$3,595	\$2,876	\$25
IBTF-D-YSS-HF	Ideal BarTap. High Flow in PVD Brushed Gold Stainless Steel and Water Filtration System	\$3,595	\$2,876	\$25
IDS-1-BSS	Ideal Deck Switch in PVD Satin Black Stainless Steel	\$595	\$476	\$15
IDS-1-GSS	Ideal Deck Switch in PVD Gun Metal Gray™ Stainless Steel	\$595	\$476	\$15
IDS-1-MSS	Ideal Deck Switch in Matte Stainless Steel	\$495	\$396	\$15
IDS-1-PSS	Ideal Deck Switch in Polished Stainless Steel	\$495	\$396	\$15
IDS-1-RSS	Ideal Deck Switch in PVD Polished Rose Gold Stainless Steel	\$650	\$520	\$15
IDS-1-YSS	Ideal Deck Switch in PVD Brushed Gold Stainless Steel	\$650	\$520	\$15
IHC-1-BSS	Ideal Hole Cover in PVD Satin Black Stainless Steel	\$230	\$184	\$15
IHC-1-GSS	Ideal Hole Cover in PVD Gun Metal Gray™ Stainless Steel	\$230	\$184	\$15
IHC-1-MSS	Ideal Hole Cover in Matte Stainless Steel	\$180	\$144	\$15
IHC-1-PSS	Ideal Hole Cover in Polished Stainless Steel	\$180	\$144	\$15
IHC-1-RSS	Ideal Hole Cover in PVD Polished Rose Gold Stainless Steel	\$260	\$208	\$15
IHC-1-YSS	Ideal Hole Cover in PVD Brushed Gold Stainless Steel	\$260	\$208	\$15
IHS-1-V-BA	Ideal HydroStation™ with HydroPlate in Natural Golden Bamboo	\$1,250	\$1,125	\$55
IHS-1-V-GR	Ideal HydroStation™ with HydroPlate in Exclusive Gray Resin	\$1,225	\$1,103	\$55
IHS-1-V-GT	Ideal HydroStation™ with HydroPlate in Graphite Wood Composite	\$1,250	\$1,125	\$55
IHS-1-V-WA	Ideal HydroStation™ with HydroPlate in American Black Walnut	\$1,275	\$1,148	\$55
IHS-1-V-WH	Ideal HydroStation™ with HydroPlate in Designer White Resin	\$1,225	\$1,103	\$55
IHS-1-V-TT-BA	Ideal ThinTop™ HydroStation™ with HydroPlate in Natural Golden Bamboo	\$1,500	\$1,350	\$55
IHS-1-V-TT-GR	Ideal ThinTop™ HydroStation™ with HydroPlate in Exclusive Gray Resin	\$1,475	\$1,328	\$55
IHS-1-V-TT-GT	Ideal ThinTop™ HydroStation™ with HydroPlate in Graphite Wood Composite	\$1,500	\$1,350	\$55
IHS-1-V-TT-WA	Ideal ThinTop™ HydroStation™ with HydroPlate in American Black Walnut	\$1,525	\$1,373	\$55
IHS-1-V-TT-WH	Ideal ThinTop™ HydroStation™ with HydroPlate in Designer White Resin	\$1,475	\$1,328	\$55
IHT-D-BSS	Ideal Hot & Cold Tap in PVD Satin Black Stainless Steel and Ideal Digital Hot Water Tank™	\$2,675	\$2,140	\$25
IHT-D-GSS	Ideal Hot & Cold Tap in PVD Gun Metal Gray™ Stainless Steel and Ideal Digital Hot Water Tank™	\$2,675	\$2,140	\$25
IHT-D-MSS	Ideal Hot & Cold Tap in Matte Stainless Steel and Ideal Digital Hot Water Tank™	\$2,275	\$1,820	\$25
IHT-D-PSS	Ideal Hot & Cold Tap in Polished Stainless Steel and Ideal Digital Hot Water Tank™	\$2,275	\$1,820	\$25
IHT-D-RSS	Ideal Hot & Cold Tap in PVD Polished Rose Gold Stainless Steel and Ideal Digital Hot Water Tank™	\$2,875	\$2,300	\$25
IHT-D-YSS	Ideal Hot & Cold Tap in PVD Brushed Gold Stainless Steel and Ideal Digital Hot Water Tank™	\$2,875	\$2,300	\$25
IHTF-D-BSS	Ideal Hot & Cold Tap in PVD Satin Black Stainless Steel, Ideal Digital Hot Water Tank™ and Water Filtration System	\$2,895	\$2,316	\$25
IHTF-D-GSS	Ideal Hot & Cold Tap in PVD Gun Metal Gray™ Stainless Steel, Ideal Digital Hot Water Tank™ and Water Filtration System	\$2,895	\$2,316	\$25
IHTF-D-MSS	Ideal Hot & Cold Tap in Matte Stainless Steel, Ideal Digital Hot Water Tank™ and Water Filtration System	\$2,495	\$1,996	\$25
IHTF-D-PSS	Ideal Hot & Cold Tap in Polished Stainless Steel, Ideal Digital Hot Water Tank™ and Water Filtration System	\$2,495	\$1,996	\$25
IHTF-D-RSS	Ideal Hot & Cold Tap in PVD Polished Rose Gold Stainless Steel, Ideal Digital Hot Water Tank™ and Water Filtration System	\$3,095	\$2,476	\$25
IHTF-D-YSS	Ideal Hot & Cold Tap in PVD Brushed Gold Stainless Steel, Ideal Digital Hot Water Tank™ and Water Filtration System	\$3,095	\$2,476	\$25
IPT-D-BSS	Ideal Pot Filler Tap in PVD Satin Black Stainless Steel	\$2,375	\$1,900	\$25
IPT-D-GSS	Ideal Pot Filler Tap in PVD Gun Metal Gray™ Stainless Steel	\$2,375	\$1,900	\$25
IPT-D-MSS	Ideal Pot Filler Tap in Matte Stainless Steel	\$1,775	\$1,420	\$25
IPT-D-PSS	Ideal Pot Filler Tap in Polished Stainless Steel	\$1,775	\$1,420	\$25
IPT-D-RSS	Ideal Pot Filler Tap in PVD Polished Rose Gold Stainless Steel	\$2,675	\$2,140	\$25
IPT-D-YSS	Ideal Pot Filler Tap in PVD Brushed Gold Stainless Steel	\$2,675	\$2,140	\$25
IPTF-D-BSS	Ideal Pot Filler Tap in PVD Satin Black Stainless Steel and Water Filtration System	\$2,595	\$2,076	\$25
IPTF-D-GSS	Ideal Pot Filler Tap in PVD Gun Metal Gray™ Stainless Steel and Water Filtration System	\$2,595	\$2,076	\$25
IPTF-D-MSS	Ideal Pot Filler Tap in Matte Stainless Steel and Water Filtration System	\$1,995	\$1,596	\$25
IPTF-D-PSS	Ideal Pot Filler Tap in Polished Stainless Steel and Water Filtration System	\$1,995	\$1,596	\$25
IPTF-D-RSS	Ideal Pot Filler Tap in PVD Polished Rose Gold Stainless Steel and Water Filtration System	\$2,895	\$2,316	\$25
IPTF-D-YSS	Ideal Pot Filler Tap in PVD Brushed Gold Stainless Steel and Water Filtration System	\$2,895	\$2,316	\$25
ISD-1-BSS	Ideal Soap Dispenser in PVD Satin Black Stainless Steel	\$895	\$716	\$15
ISD-1-GSS	Ideal Soap Dispenser in PVD Gun Metal Gray™ Finish Stainless Steel	\$895	\$716	\$15
ISD-1-MSS	Ideal Soap Dispenser in Matte Finish Stainless Steel	\$695	\$556	\$15
ISD-1-PSS	Ideal Soap Dispenser in Polished Stainless Steel	\$695	\$556	\$15
ISD-1-RSS	Ideal Soap Dispenser in PVD Polished Rose Gold Stainless Steel	\$995	\$796	\$15
ISD-1-YSS	Ideal Soap Dispenser in PVD Brushed Gold Stainless Steel	\$995	\$796	\$15
IWA-2-C-BA	Ideal WashStation™ 2C with Four Tool Wash Kit in Natural Golden Bamboo / Exclusive Gray Resin+	\$2,995	\$2,696	\$99
IWA-2-C-GR	Ideal WashStation™ 2C with Four Tool Wash Kit in Exclusive Gray Resin / Resin+	\$2,895	\$2,606	\$99
IWA-2-C-GT	Ideal WashStation™ 2C with Four Tool Wash Kit in Graphite Wood Composite / Graphite Resin+	\$2,995	\$2,696	\$99
IWA-2-C-WA	Ideal WashStation™ 2C with Four Tool Wash Kit in American Black Walnut / Graphite Resin+	\$3,095	\$2,786	\$99
IWA-2-C-WH	Ideal WashStation™ 2C with Four Tool Wash Kit in Designer White Resin / Resin+	\$2,895	\$2,606	\$99
IWA-30-S-DD-12-S-BA	Ideal WashStation™ 30S + 12" DryDock. Drain Side, Four Tool Wash Kit, One DryDock Tool in Natural Golden Bamboo / Gray Resin+	\$5,070	\$4,563	\$249*
IWA-30-S-DD-12-S-GR	Ideal WashStation™ 30S + 12" DryDock. Drain Side, Four Tool Wash Kit, One DryDock Tool in Exclusive Gray Resin / Resin+	\$4,920	\$4,428	\$249*
IWA-30-S-DD-12-S-GT	Ideal WashStation™ 30S + 12" DryDock. Drain Side, Four Tool Wash Kit, One DryDock Tool in Graphite Wood Composite / Resin+	\$5,070	\$4,563	\$249*
IWA-30-S-DD-12-S-WA	Ideal WashStation™ 30S + 12" DryDock. Drain Side, Four Tool Wash Kit, One DryDock Tool in American Black Walnut / Graphite Resin+	\$5,220	\$4,698	\$249*
IWA-30-S-DD-12-S-WH	Ideal WashStation™ 30S + 12" DryDock. Drain Side, Four Tool Wash Kit, One DryDock Tool in Designer White Resin / Resin+	\$4,920	\$4,428	\$249*
IWA-30-S-DD-18-S-BA	Ideal WashStation™ 30S + 18" DryDock. Drain Side, Four Tool Wash Kit, One DryDock Tool in Natural Golden Bamboo / Gray Resin+	\$5,420	\$4,878	\$249*
IWA-30-S-DD-18-S-GR	Ideal WashStation™ 30S + 18" DryDock. Drain Side, Four Tool Wash Kit, One DryDock Tool in Exclusive Gray Resin / Resin+	\$5,245	\$4,721	\$249*
IWA-30-S-DD-18-S-GT	Ideal WashStation™ 30S + 18" DryDock. Drain Side, Four Tool Wash Kit, One DryDock Tool in Graphite Wood Composite / Resin+	\$5,420	\$4,878	\$249*
IWA-30-S-DD-18-S-WA	Ideal WashStation™ 30S + 18" DryDock. Drain Side, Four Tool Wash Kit, One DryDock Tool in American Black Walnut / Graphite Resin+	\$5,570	\$5,013	\$249*
IWA-30-S-DD-18-S-WH	Ideal WashStation™ 30S + 18" DryDock. Drain Side, Four Tool Wash Kit, One DryDock Tool in Designer White Resin / Resin+	\$5,245	\$4,721	\$249*
IWA-30-S-BA	Ideal WashStation™ 30S with Four Tool Wash Kit in Natural Golden Bamboo / Exclusive Gray Resin+	\$3,295	\$2,966	\$99
IWA-30-S-GR	Ideal WashStation™ 30S with Four Tool Wash Kit in Exclusive Gray Resin / Resin+	\$3,195	\$2,876	\$99
IWA-30-S-GT	Ideal WashStation™ 30S with Four Tool Wash Kit in Graphite Wood Composite / Graphite Resin+	\$3,295	\$2,966	\$99
IWA-30-S-WA	Ideal WashStation™ 30S with Four Tool Wash Kit in American Black Walnut / Graphite Resin+	\$3,395	\$3,056	\$99
IWA-30-S-WH	Ideal WashStation™ 30S with Four Tool Wash Kit in Designer White Resin / Resin+	\$3,195	\$2,876	\$99
IWA-3-S-DD-12-S-BA	Ideal WashStation™ 3S + 12" DryDock. Drain Side, Four Tool Wash Kit, One DryDock Tool in Natural Golden Bamboo / Gray Resin+	\$5,370	\$4,833	\$249*

Product Index

Sorted by product code

Product code	Description	MSRP	UMRP	Freight
IWS-5-S-TT-GT	Ideal ThinTop™ Workstation 5S with Eight Tool Culinary Kit in Graphite Wood Composite	\$6,495	\$5,846	\$249*
IWS-5-S-TT-WA	Ideal ThinTop™ Workstation 5S with Eight Tool Culinary Kit in American Black Walnut	\$6,995	\$6,296	\$249*
IWS-5-S-TT-WH	Ideal ThinTop™ Workstation 5S with Eight Tool Culinary Kit in Designer White Resin	\$6,095	\$5,486	\$249*
IWS-6-S-BA	Ideal Workstation 6S with Eight Tool Culinary Kit in Natural Golden Bamboo	\$6,595	\$5,936	\$249*
IWS-6-S-GR	Ideal Workstation 6S with Eight Tool Culinary Kit in Exclusive Gray Resin	\$6,195	\$5,576	\$249*
IWS-6-S-GT	Ideal Workstation 6S with Eight Tool Culinary Kit in Graphite Wood Composite	\$6,595	\$5,936	\$249*
IWS-6-S-WA	Ideal Workstation 6S with Eight Tool Culinary Kit in American Black Walnut	\$7,095	\$6,386	\$249*
IWS-6-S-WH	Ideal Workstation 6S with Eight Tool Culinary Kit in Designer White Resin	\$6,195	\$5,576	\$249*
IWS-7-S-BA	Ideal Workstation 7S with Eight Tool Culinary Kit in Natural Golden Bamboo	\$7,195	\$6,476	\$449*
IWS-7-S-GR	Ideal Workstation 7S with Eight Tool Culinary Kit in Exclusive Gray Resin	\$6,795	\$6,116	\$449*
IWS-7-S-GT	Ideal Workstation 7S with Eight Tool Culinary Kit in Graphite Wood Composite	\$7,195	\$6,476	\$449*
IWS-7-S-WA	Ideal Workstation 7S with Eight Tool Culinary Kit in American Black Walnut	\$7,695	\$6,926	\$449*
IWS-7-S-WH	Ideal Workstation 7S with Eight Tool Culinary Kit in Designer White Resin	\$6,795	\$6,116	\$449*
IWT-D-BSS-EF	Ideal Tap Eco Flow in PVD Satin Black Stainless Steel	\$3,175	\$2,540	\$25
IWT-D-BSS-HF	Ideal Tap High Flow in PVD Satin Black Stainless Steel	\$3,175	\$2,540	\$25
IWT-D-GSS-EF	Ideal Tap Eco Flow in PVD Gun Metal Gray™ Stainless Steel	\$3,175	\$2,540	\$25
IWT-D-GSS-HF	Ideal Tap High Flow in PVD Gun Metal Gray™ Stainless Steel	\$3,175	\$2,540	\$25
IWT-D-MSS-EF	Ideal Tap Eco Flow in Matte Stainless Steel	\$2,375	\$1,900	\$25
IWT-D-MSS-HF	Ideal Tap High Flow in Matte Stainless Steel	\$2,375	\$1,900	\$25
IWT-D-PSS-EF	Ideal Tap Eco Flow in Polished Stainless Steel	\$2,375	\$1,900	\$25
IWT-D-PSS-HF	Ideal Tap High Flow in Polished Stainless Steel	\$2,375	\$1,900	\$25
IWT-D-RSS-EF	Ideal Tap Eco Flow in PVD Polished Rose Gold Stainless Steel	\$3,475	\$2,780	\$25
IWT-D-RSS-HF	Ideal Tap High Flow in PVD Polished Rose Gold Stainless Steel	\$3,475	\$2,780	\$25
IWT-D-YSS-EF	Ideal Tap Eco Flow in PVD Brushed Gold Stainless Steel	\$3,475	\$2,780	\$25
IWT-D-YSS-HF	Ideal Tap High Flow in PVD Brushed Gold Stainless Steel	\$3,475	\$2,780	\$25
IWTF-D-BSS-EF	Ideal Tap Eco Flow in PVD Satin Black Stainless Steel and Water Filtration System	\$3,395	\$2,716	\$25
IWTF-D-BSS-HF	Ideal Tap High Flow in PVD Satin Black Stainless Steel and Water Filtration System	\$3,395	\$2,716	\$25
IWTF-D-GSS-EF	Ideal Tap Eco Flow in PVD Gun Metal Gray™ Stainless Steel and Water Filtration System	\$3,395	\$2,716	\$25
IWTF-D-GSS-HF	Ideal Tap High Flow in PVD Gun Metal Gray™ Stainless Steel and Water Filtration System	\$3,395	\$2,716	\$25
IWTF-D-MSS-EF	Ideal Tap Eco Flow in Matte Stainless Steel and Water Filtration System	\$2,595	\$2,076	\$25
IWTF-D-MSS-HF	Ideal Tap High Flow in Matte Stainless Steel and Water Filtration System	\$2,595	\$2,076	\$25
IWTF-D-PSS-EF	Ideal Tap Eco Flow in Polished Stainless Steel and Water Filtration System	\$2,595	\$2,076	\$25
IWTF-D-PSS-HF	Ideal Tap High Flow in Polished Stainless Steel and Water Filtration System	\$2,595	\$2,076	\$25
IWTF-D-RSS-EF	Ideal Tap Eco Flow in PVD Polished Rose Gold Stainless Steel and Water Filtration System	\$3,695	\$2,956	\$25
IWTF-D-RSS-HF	Ideal Tap High Flow in PVD Polished Rose Gold Stainless Steel and Water Filtration System	\$3,695	\$2,956	\$25
IWTF-D-YSS-EF	Ideal Tap Eco Flow in PVD Brushed Gold Stainless Steel and Water Filtration System	\$3,695	\$2,956	\$25
IWTF-D-YSS-HF	Ideal Tap High Flow in PVD Brushed Gold Stainless Steel and Water Filtration System	\$3,695	\$2,956	\$25
IWW-4-D-BA	Ideal Work&WashStation™ 4D with Five Tool Culinary Kit and Four Tool Wash Kit in Natural Golden Bamboo / Exclusive Gray Resin+	\$7,195	\$6,476	\$249*
IWW-4-D-GR	Ideal Work&WashStation™ 4D with Five Tool Culinary Kit and Four Tool Wash Kit in Exclusive Gray Resin / Resin+	\$6,795	\$6,116	\$249*
IWW-4-D-GT	Ideal Work&WashStation™ 4D with Five Tool Culinary Kit and Four Tool Wash Kit in Graphite Wood Composite / Graphite Resin+	\$7,195	\$6,476	\$249*
IWW-4-D-WA	Ideal Work&WashStation™ 4D with Five Tool Culinary Kit and Four Tool Wash Kit in American Black Walnut / Graphite Resin+	\$7,695	\$6,926	\$249*
IWW-4-D-WH	Ideal Work&WashStation™ 4D with Five Tool Culinary Kit and Four Tool Wash Kit in Designer White Resin / Resin+	\$6,795	\$6,116	\$249*
IWW-5-D-BA	Ideal Work&WashStation™ 5D with Five Tool Culinary Kit and Four Tool Wash Kit in Natural Golden Bamboo / Exclusive Gray Resin+	\$8,195	\$7,376	\$249*
IWW-5-D-GR	Ideal Work&WashStation™ 5D with Five Tool Culinary Kit and Four Tool Wash Kit in Exclusive Gray Resin / Resin+	\$7,795	\$7,016	\$249*
IWW-5-D-GT	Ideal Work&WashStation™ 5D with Five Tool Culinary Kit and Four Tool Wash Kit in Graphite Wood Composite / Graphite Resin+	\$8,195	\$7,376	\$249*
IWW-5-D-WA	Ideal Work&WashStation™ 5D with Five Tool Culinary Kit and Four Tool Wash Kit in American Black Walnut / Graphite Resin+	\$8,695	\$7,826	\$249*
IWW-5-D-WH	Ideal Work&WashStation™ 5D with Five Tool Culinary Kit and Four Tool Wash Kit in Designer White Resin / Resin+	\$7,795	\$7,016	\$249*
IWW-6-D-BA	Ideal Work&WashStation™ 6D with Five Tool Culinary Kit and Four Tool Wash Kit in Natural Golden Bamboo / Exclusive Gray Resin+	\$8,795	\$7,916	\$249*
IWW-6-D-GR	Ideal Work&WashStation™ 6D with Five Tool Culinary Kit and Four Tool Wash Kit in Exclusive Gray Resin / Resin+	\$8,395	\$7,556	\$249*
IWW-6-D-GT	Ideal Work&WashStation™ 6D with Five Tool Culinary Kit and Four Tool Wash Kit in Graphite Wood Composite / Graphite Resin+	\$8,795	\$7,916	\$249*
IWW-6-D-WA	Ideal Work&WashStation™ 6D with Five Tool Culinary Kit and Four Tool Wash Kit in American Black Walnut / Graphite Resin+	\$9,295	\$8,366	\$249*
IWW-6-D-WH	Ideal Work&WashStation™ 6D with Five Tool Culinary Kit and Four Tool Wash Kit in Designer White Resin / Resin+	\$8,395	\$7,556	\$249*
IWW-7-D-BA	Ideal Work&WashStation™ 7D with Eight Tool Culinary Kit and Four Tool Wash Kit in Natural Golden Bamboo / Exclusive Gray Resin+	\$10,195	\$9,176	\$449*
IWW-7-D-GR	Ideal Work&WashStation™ 7D with Eight Tool Culinary Kit and Four Tool Wash Kit in Exclusive Gray Resin / Resin+	\$9,695	\$8,726	\$449*
IWW-7-D-GT	Ideal Work&WashStation™ 7D with Eight Tool Culinary Kit and Four Tool Wash Kit in Graphite Wood Composite / Graphite Resin+	\$10,195	\$9,176	\$449*
IWW-7-D-WA	Ideal Work&WashStation™ 7D with Eight Tool Culinary Kit and Four Tool Wash Kit in American Black Walnut / Graphite Resin+	\$10,795	\$9,716	\$449*
IWW-7-D-WH	Ideal Work&WashStation™ 7D with Eight Tool Culinary Kit and Four Tool Wash Kit in Designer White Resin / Resin+	\$9,695	\$8,726	\$449*
KB-03-C-BA	Countertop Recessed Magnetic Knife Block in Natural Golden Bamboo	\$175	\$158	\$25
KB-03-C-GT	Countertop Recessed Magnetic Knife Block in Graphite Wood Composite	\$175	\$158	\$25
KB-03-C-WA	Countertop Recessed Magnetic Knife Block in American Black Walnut	\$250	\$225	\$25
KSO-18-C-SS	Basin Portion of IBS 18C in Angel Finish 316L Stainless Steel	\$1,795	\$1,616	\$54
KSO-18-C-TT-SS	Basin Portion of IBS 18C TT in Angel Finish 316L Stainless Steel	\$2,295	\$2,066	\$54
KSO-2-C-SS	Basin Portion of IWS 2C, IWA 2C, IBS 2C in Angel Finish 316L Stainless Steel	\$2,095	\$1,886	\$54
KSO-30-S-DS-12-S-SS	Basin Portion of IWS 30S + DD12, IWA 30S + DD12 in Angel Finish 316L Stainless Steel	\$3,895	\$3,506	\$204*
KSO-30-S-DS-18-S-SS	Basin Portion of IWS 30S + DD18, IWA 30S + DD18 in Angel Finish 316L Stainless Steel	\$4,195	\$3,776	\$204*
KSO-30-S-SS	Basin Portion of IWS 30S, IWA 30S in Angel Finish 316L Stainless Steel	\$2,395	\$2,156	\$54
KSO-3-S-DS-12-S-SS	Basin Portion of IWS 3S + DD12, IWA 3S + DD12 in Angel Finish 316L Stainless Steel	\$4,195	\$3,776	\$204*
KSO-3-S-DS-12-S-TT-SS	Basin Portion of IWS 3S + DD12 TT, IWA 3S + DD12 TT in Angel Finish 316L Stainless Steel	\$4,695	\$4,226	\$204*
KSO-3-S-DS-18-S-SS	Basin Portion of IWS 3S + DD18, IWA 3S + DD18 in Angel Finish 316L Stainless Steel	\$4,495	\$4,046	\$204*
KSO-3-S-SS	Basin Portion of IWS 3S, IWA 3S in Angel Finish 316L Stainless Steel	\$2,695	\$2,426	\$54
KSO-3-S-TT-SS	Basin Portion of IWA 3S TT in Angel Finish 316L Stainless Steel	\$3,195	\$2,876	\$54
KSO-3X4-C-SS	Basin Portion of IWS 3X4C, IWA 3X4C in Angel Finish 316L Stainless Steel	\$6,095	\$5,486	\$204*
KSO-4-D-SS	Basin Portion of IWA 4D, IWW 4D in Angel Finish 316L Stainless Steel	\$5,095	\$4,586	\$204*
KSO-4-S-DS-12-S-SS	Basin Portion of IWS 4S + DD12, IWA 4S + DD12 in Angel Finish 316L Stainless Steel	\$5,195	\$4,676	\$204*
KSO-4-S-DS-18-S-SS	Basin Portion of IWS 4S + DD18, IWA 4S + DD18 in Angel Finish 316L Stainless Steel	\$5,495	\$4,946	\$204*
KSO-4-S-SS	Basin Portion of IWS 4S, IWA 4S in Angel Finish 316L Stainless Steel	\$3,695	\$3,326	\$204*

Product Index

Sorted by product code

Product code	Description	MSRP	UMRP	Freight
KSO-4-S-TT-SS	Basin Portion of IWS 4S TT, IWA 4S TT in Angel Finish 316L Stainless Steel	\$4,195	\$3,776	\$204*
KSO-4X3-C-SS	Basin Portion of IWS 4X3C, IWA 4X3C in Angel Finish 316L Stainless Steel	\$6,095	\$5,486	\$204*
KSO-4X4-C-SS	Basin Portion of IWS 4X4C, IWA 4X4C in Angel Finish 316L Stainless Steel	\$7,095	\$6,386	\$204*
KSO-5-D-SS	Basin Portion of IWW 5D in Angel Finish 316L Stainless Steel	\$6,095	\$5,486	\$204*
KSO-5-S-SS	Basin Portion of IWS 5S in Angel Finish 316L Stainless Steel	\$4,295	\$3,866	\$204*
KSO-5-S-TT-SS	Basin Portion of IWS 5S TT in Angel Finish 316L Stainless Steel	\$4,795	\$4,316	\$204*
KSO-6-D-SS	Basin Portion of IWW 6D in Angel Finish 316L Stainless Steel	\$6,695	\$6,026	\$204*
KSO-6-S-SS	Basin Portion of IWS 6S in Angel Finish 316L Stainless Steel	\$4,895	\$4,406	\$204*
KSO-7-D-SS	Basin Portion of IWW 7D in Angel Finish 316L Stainless Steel	\$7,595	\$6,836	\$404*
KSO-7-S-SS	Basin Portion of IWS 7S in Angel Finish 316L Stainless Steel	\$5,495	\$4,946	\$404*
LKT-3T-BA	Corner Kit including Three Tools in Natural Golden Bamboo	\$750	\$675	\$45
LKT-3T-GR	Corner Kit including Three Tools in Exclusive Gray Resin	\$600	\$540	\$45
LKT-3T-GT	Corner Kit including Three Tools in Graphite Wood Composite	\$750	\$675	\$45
LKT-3T-WA	Corner Kit including Three Tools in American Black Walnut	\$900	\$810	\$45
LKT-3T-WH	Corner Kit including Three Tools in Designer White Resin	\$600	\$540	\$45
M-DRN-MSS	Manual Strainer Basket 3-1/2" in Angel Finish Stainless Steel	\$110	\$99	\$15
MG-05-0-SS	Mini Grate Only for Utensil Caddy 4-1/2" x 4-1/2" in Stainless Steel	\$75	\$68	\$10
OKT-5T-GR	Outdoor Kit including Five Tools in Exclusive Gray Resin	\$800	\$720	\$45
OKT-5T-GT	Outdoor Kit including Five Tools in Graphite Wood Composite	\$1,000	\$900	\$45
OKT-5T-WH	Outdoor Kit including Five Tools in Designer White Resin	\$800	\$720	\$45
P1-12-L-ADA-BA	Lower Tier ADA Platform Only 12-1/4" x 17" for ADA Mixing Bowl 11" and Colander 11" in Natural Golden Bamboo	\$200	\$180	\$25
P1-12-L-BA	Lower Tier Platform Only 12-1/4" x 17" for Mixing Bowl 11" and Colander 11" in Natural Golden Bamboo	\$200	\$180	\$25
P1-12-L-ADA-GR	Lower Tier ADA Platform Only 12-1/4" x 17" for ADA Mixing Bowl 11" and Colander 11" in Exclusive Gray Resin	\$150	\$135	\$25
P1-12-L-GR	Lower Tier Platform Only 12-1/4" x 17" for Mixing Bowl 11" and Colander 11" in Exclusive Gray Resin	\$150	\$135	\$25
P1-12-L-ADA-GT	Lower Tier ADA Platform Only 12-1/4" x 17" for ADA Mixing Bowl 11" and Colander 11" in Graphite Wood Composite	\$200	\$180	\$25
P1-12-L-GT	Lower Tier Platform Only 12-1/4" x 17" for Mixing Bowl 11" and Colander 11" in Graphite Wood Composite	\$200	\$180	\$25
P1-12-L-ADA-WA	Lower Tier ADA Platform Only 12-1/4" x 17" for ADA Mixing Bowl 11" and Colander 11" in American Black Walnut	\$275	\$248	\$25
P1-12-L-WA	Lower Tier Platform Only 12-1/4" x 17" for Mixing Bowl 11" and Colander 11" in American Black Walnut	\$275	\$248	\$25
P1-12-L-ADA-WH	Lower Tier ADA Platform Only 12-1/4" x 17" for ADA Mixing Bowl 11" and Colander 11" in Designer White Resin	\$150	\$135	\$25
P1-12-L-WH	Lower Tier Platform Only 12-1/4" x 17" for Mixing Bowl 11" and Colander 11" in Designer White Resin	\$150	\$135	\$25
P2-17-D-ADA-BA	Dual Tier ADA Platform Only 17" x 18" for ADA Mixing Bowl 11" and Colander 11" in Natural Golden Bamboo	\$225	\$203	\$25
P2-17-D-BA	Dual Tier Platform Only 17" x 18" for Mixing Bowl 11" and Colander 11" in Natural Golden Bamboo	\$225	\$203	\$25
P2-17-D-ADA-GR	Dual Tier ADA Platform Only 17" x 18" for ADA Mixing Bowl 11" and Colander 11" in Exclusive Gray Resin	\$175	\$158	\$25
P2-17-D-GR	Dual Tier Platform Only 17" x 18" for Mixing Bowl 11" and Colander 11" in Exclusive Gray Resin	\$175	\$158	\$25
P2-17-D-ADA-GT	Dual Tier ADA Platform Only 17" x 18" for ADA Mixing Bowl 11" and Colander 11" in Graphite Wood Composite	\$225	\$203	\$25
P2-17-D-GT	Dual Tier Platform Only 17" x 18" for Mixing Bowl 11" and Colander 11" in Graphite Wood Composite	\$225	\$203	\$25
P2-17-D-ADA-WA	Dual Tier ADA Platform Only 17" x 18" for ADA Mixing Bowl 11" and Colander 11" in American Black Walnut	\$300	\$270	\$25
P2-17-D-WA	Dual Tier Platform Only 17" x 18" for Mixing Bowl 11" and Colander 11" in American Black Walnut	\$300	\$270	\$25
P2-17-D-ADA-WH	Dual Tier ADA Platform Only 17" x 18" for ADA Mixing Bowl 11" and Colander 11" in Designer White Resin	\$175	\$158	\$25
P2-17-D-WH	Dual Tier Platform Only 17" x 18" for Mixing Bowl 11" and Colander 11" in Designer White Resin	\$175	\$158	\$25
P3-17-D-BA	Dual Tier Platform Only for Wash & Serve Set 17" x 18" in Natural Golden Bamboo	\$225	\$203	\$25
P3-17-D-GR	Dual Tier Platform Only for Wash & Serve Set 17" x 18" in Exclusive Gray Resin	\$150	\$135	\$25
P3-17-D-GT	Dual Tier Platform Only for Wash & Serve Set 17" x 18" in Graphite Wood Composite	\$225	\$203	\$25
P3-17-D-WA	Dual Tier Platform Only for Wash & Serve Set 17" x 18" in American Black Walnut	\$300	\$270	\$25
P3-17-D-WH	Dual Tier Platform Only for Wash & Serve Set 17" x 18" in Designer White Resin	\$150	\$135	\$25
P4-17-C-BA	Lower Tier Corner Platform Only for Wash & Serve Set 17-1/2" x 17-1/2" in Natural Golden Bamboo	\$250	\$225	\$25
P4-17-C-GR	Lower Tier Corner Platform Only for Wash & Serve Set 17-1/2" x 17-1/2" in Exclusive Gray Resin	\$175	\$158	\$25
P4-17-C-GT	Lower Tier Corner Platform Only for Wash & Serve Set 17-1/2" x 17-1/2" in Graphite Wood Composite	\$250	\$225	\$25
P4-17-C-WA	Lower Tier Corner Platform Only for Wash & Serve Set 17-1/2" x 17-1/2" in American Black Walnut	\$325	\$293	\$25
P4-17-C-WH	Lower Tier Corner Platform Only for Wash & Serve Set 17-1/2" x 17-1/2" in Designer White Resin	\$175	\$158	\$25
P5-7X7-BA	HydroPlate Platform Only 7" x 7" in Natural Golden Bamboo	\$100	\$90	\$25
P5-7X7-GR	HydroPlate Platform Only 7" x 7" in Exclusive Gray Resin	\$75	\$68	\$25
P5-7X7-GT	HydroPlate Platform Only 7" x 7" in Graphite Wood Composite	\$100	\$90	\$25
P5-7X7-WA	HydroPlate Platform Only 7" x 7" in American Black Walnut	\$125	\$113	\$25
P5-7X7-WH	HydroPlate Platform Only 7" x 7" in Designer White Resin	\$75	\$68	\$25
PC-04-0-SS	Cylinder Only 4-1/2" for Utensil Caddy in Stainless Steel	\$10	\$9	N/C
P-DRN-CIT	Pop-up Basin Strainer & Stopper in Citrine	\$25	\$23	N/C
PFT-RO-SS	Ideal Pot Filler Tap Required Rough-in Part	\$300	\$240	\$25
RFC-79-HF	Replacement Cartridge for Water Filtration System	\$195	\$156	\$25
S1-06-U-BA	Upper Tier Garnish Board Platform Only 6" x 18" in Natural Golden Bamboo	\$185	\$167	\$25
S1-06-U-GR	Upper Tier Garnish Board Platform Only 6" x 18" in Exclusive Gray Resin	\$110	\$99	\$25
S1-06-U-GT	Upper Tier Garnish Board Platform Only 6" x 18" in Graphite Wood Composite	\$185	\$167	\$25
S1-06-U-WA	Upper Tier Garnish Board Platform Only 6" x 18" in American Black Walnut	\$235	\$212	\$25
S1-06-U-WH	Upper Tier Garnish Board Platform Only 6" x 18" in Designer White Resin	\$110	\$99	\$25
S2-17-D-BA	Dual Tier Serving Board Platform Only 17" x 18" in Natural Golden Bamboo	\$197	\$177	\$25
S2-17-D-GR	Dual Tier Serving Board Platform Only 17" x 18" in Exclusive Gray Resin	\$122	\$110	\$25
S2-17-D-GT	Dual Tier Serving Board Platform Only 17" x 18" in Graphite Wood Composite	\$197	\$177	\$25
S2-17-D-WA	Dual Tier Serving Board Platform Only 17" x 18" in American Black Walnut	\$272	\$245	\$25
S2-17-D-WH	Dual Tier Serving Board Platform Only 17" x 18" in Designer White Resin	\$122	\$110	\$25
S3-09-U-BA	Upper Tier Condiment Serving Board Platform Only 9" x 18" in Natural Golden Bamboo	\$176	\$158	\$25
S3-09-U-GR	Upper Tier Condiment Serving Board Platform Only 9" x 18" in Exclusive Gray Resin	\$126	\$113	\$25
S3-09-U-GT	Upper Tier Condiment Serving Board Platform Only 9" x 18" in Graphite Wood Composite	\$176	\$158	\$25
S3-09-U-WA	Upper Tier Condiment Serving Board Platform Only 9" x 18" in American Black Walnut	\$226	\$203	\$25
S3-09-U-WH	Upper Tier Condiment Serving Board Platform Only 9" x 18" in Designer White Resin	\$126	\$113	\$25
S4-06-U-BA	Upper Tier Utensil Caddy Board Platform Only 6" x 18" in Natural Golden Bamboo	\$130	\$117	\$25
S4-06-U-GR	Upper Tier Utensil Caddy Board Platform Only 6" x 18" in Exclusive Gray Resin	\$80	\$72	\$25

Product Index

Sorted by product code

Product code	Description	MSRP	UMRP	Freight
S4-06-U-GT	Upper Tier Utensil Caddy Board Platform Only 6" x 18" in Graphite Wood Composite	\$130	\$117	\$25
S4-06-U-WA	Upper Tier Utensil Caddy Board Platform Only 6" x 18" in American Black Walnut	\$180	\$162	\$25
S4-06-U-WH	Upper Tier Utensil Caddy Board Platform Only 6" x 18" in Designer White Resin	\$80	\$72	\$25
SB-06-U-BA	Upper Tier Garnish Board 6" x 18" with Four Stainless Steel Bowls 4" in Natural Golden Bamboo	\$300	\$270	\$25
SB-06-U-GR	Upper Tier Garnish Board 6" x 18" with Four Stainless Steel Bowls 4" in Exclusive Gray Resin	\$225	\$203	\$25
SB-06-U-GT	Upper Tier Garnish Board 6" x 18" with Four Stainless Steel Bowls 4" in Graphite Wood Composite	\$300	\$270	\$25
SB-06-U-WA	Upper Tier Garnish Board 6" x 18" with Four Stainless Steel Bowls 4" in American Black Walnut	\$350	\$315	\$25
SB-06-U-WH	Upper Tier Garnish Board 6" x 18" with Four Stainless Steel Bowls 4" in Designer White Resin	\$225	\$203	\$25
SB-09-U-BA	Upper Tier Condiment Serving Board 9" x 18" with Three Stainless Steel Containers and Lids in Natural Golden Bamboo	\$250	\$225	\$25
SB-09-U-GR	Upper Tier Condiment Serving Board 9" x 18" with Three Stainless Steel Containers and Lids in Exclusive Gray Resin	\$200	\$180	\$25
SB-09-U-GT	Upper Tier Condiment Serving Board 9" x 18" with Three Stainless Steel Containers and Lids in Graphite Wood Composite	\$250	\$225	\$25
SB-09-U-WA	Upper Tier Condiment Serving Board 9" x 18" with Three Stainless Steel Containers and Lids in American Black Walnut	\$300	\$270	\$25
SB-09-U-WH	Upper Tier Condiment Serving Board 9" x 18" with Three Stainless Steel Containers and Lids in Designer White Resin	\$200	\$180	\$25
SB-17-D-BA	Dual Tier Condiment Serving Board 17" x 18" with Six Stainless Steel Containers and Lids in Natural Golden Bamboo	\$350	\$315	\$25
SB-17-D-GR	Dual Tier Condiment Serving Board 17" x 18" with Six Stainless Steel Containers and Lids in Exclusive Gray Resin	\$275	\$248	\$25
SB-17-D-GT	Dual Tier Condiment Serving Board 17" x 18" with Six Stainless Steel Containers and Lids in Graphite Wood Composite	\$350	\$315	\$25
SB-17-D-WA	Dual Tier Condiment Serving Board 17" x 18" with Six Stainless Steel Containers and Lids in American Black Walnut	\$425	\$383	\$25
SB-17-D-WH	Dual Tier Condiment Serving Board 17" x 18" with Six Stainless Steel Containers and Lids in Designer White Resin	\$275	\$248	\$25
UC-06-U-BA	Upper Tier Utensil Caddy 6" x 18" with Mini Grate and Two Cylinders in Natural Golden Bamboo	\$225	\$203	\$25
UC-06-U-GR	Upper Tier Utensil Caddy 6" x 18" with Mini Grate and Two Cylinders in Exclusive Gray Resin	\$175	\$158	\$25
UC-06-U-GT	Upper Tier Utensil Caddy 6" x 18" with Mini Grate and Two Cylinders in Graphite Wood Composite	\$225	\$203	\$25
UC-06-U-WA	Upper Tier Utensil Caddy 6" x 18" with Mini Grate and Two Cylinders in American Black Walnut	\$275	\$248	\$25
UC-06-U-WH	Upper Tier Utensil Caddy 6" x 18" with Mini Grate and Two Cylinders in Designer White Resin	\$175	\$158	\$25
UD-06-I-BA	Upper Deck. 6" x 19" Section in Natural Golden Bamboo	\$175	\$158	\$25
UD-06-I-GR	Upper Deck. 6" x 19" Section in Exclusive Gray Resin	\$100	\$90	\$25
UD-06-I-GT	Upper Deck. 6" x 19" Section in Graphite Wood Composite	\$175	\$158	\$25
UD-06-I-WA	Upper Deck. 6" x 19" Section in American Black Walnut	\$275	\$248	\$25
UD-06-I-WH	Upper Deck. 6" x 19" Section in Designer White Resin	\$100	\$90	\$25
UD-09-I-BA	Upper Deck. 9" x 19" Section in Natural Golden Bamboo	\$175	\$158	\$25
UD-09-I-GR	Upper Deck. 9" x 19" Section in Exclusive Gray Resin	\$100	\$90	\$25
UD-09-I-GT	Upper Deck. 9" x 19" Section in Graphite Wood Composite	\$175	\$158	\$25
UD-09-I-WA	Upper Deck. 9" x 19" Section in American Black Walnut	\$275	\$248	\$25
UD-09-I-WH	Upper Deck. 9" x 19" Section in Designer White Resin	\$100	\$90	\$25
UD-1-1P-BA	Upper Deck. One Piece Set for IHS in Natural Golden Bamboo	\$150	\$135	\$25
UD-1-1P-GR	Upper Deck. One Piece Set for IHS in Exclusive Gray Resin	\$75	\$68	\$25
UD-1-1P-GT	Upper Deck. One Piece Set for IHS in Graphite Wood Composite	\$150	\$135	\$25
UD-1-1P-WA	Upper Deck. One Piece Set for IHS in American Black Walnut	\$250	\$225	\$25
UD-1-1P-WH	Upper Deck. One Piece Set for IHS in Designer White Resin	\$75	\$68	\$25
UD-12-I-BA	Upper Deck. 12" x 19" Section in Natural Golden Bamboo	\$200	\$180	\$25
UD-12-I-GR	Upper Deck. 12" x 19" Section in Exclusive Gray Resin	\$125	\$113	\$25
UD-12-I-GT	Upper Deck. 12" x 19" Section in Graphite Wood Composite	\$200	\$180	\$25
UD-12-I-WA	Upper Deck. 12" x 19" Section in American Black Walnut	\$300	\$270	\$25
UD-12-I-WH	Upper Deck. 12" x 19" Section in Designer White Resin	\$125	\$113	\$25
UD-18-2P-BA	Upper Deck. Two Piece Set for IBS 18C in Natural Golden Bamboo	\$350	\$315	\$35
UD-18-2P-GR	Upper Deck. Two Piece Set for IBS 18C in Exclusive Gray Resin	\$200	\$180	\$35
UD-18-2P-GT	Upper Deck. Two Piece Set for IBS 18C in Graphite Wood Composite	\$350	\$315	\$35
UD-18-2P-WA	Upper Deck. Two Piece Set for IBS 18C in American Black Walnut	\$550	\$495	\$35
UD-18-2P-WH	Upper Deck. Two Piece Set for IBS 18C in Designer White Resin	\$200	\$180	\$35
UD-18-I-BA	Upper Deck. 18" x 19" Section in Natural Golden Bamboo	\$225	\$203	\$25
UD-18-I-GR	Upper Deck. 18" x 19" Section in Exclusive Gray Resin	\$150	\$135	\$25
UD-18-I-GT	Upper Deck. 18" x 19" Section in Graphite Wood Composite	\$225	\$203	\$25
UD-18-I-WA	Upper Deck. 18" x 19" Section in American Black Walnut	\$325	\$293	\$25
UD-18-I-WH	Upper Deck. 18" x 19" Section in Designer White Resin	\$150	\$135	\$25
UD-2-2P-BA	Upper Deck. Two Piece Set for IWS 2C, IWA 2C, IBS 2C in Natural Golden Bamboo	\$400	\$360	\$35
UD-2-2P-GR	Upper Deck. Two Piece Set for IWS 2C, IWA 2C, IBS 2C in Exclusive Gray Resin	\$250	\$225	\$35
UD-2-2P-GT	Upper Deck. Two Piece Set for IWS 2C, IWA 2C, IBS 2C in Graphite Wood Composite	\$400	\$360	\$35
UD-2-2P-WA	Upper Deck. Two Piece Set for IWS 2C, IWA 2C, IBS 2C in American Black Walnut	\$600	\$540	\$35
UD-2-2P-WH	Upper Deck. Two Piece Set for IWS 2C, IWA 2C, IBS 2C in Designer White Resin	\$250	\$225	\$35
UD-20-C-I-BA	Upper Deck. 20" x 19" Section for Corner in Natural Golden Bamboo	\$300	\$270	\$25
UD-20-C-I-GR	Upper Deck. 20" x 19" Section for Corner in Exclusive Gray Resin	\$275	\$248	\$25
UD-20-C-I-GT	Upper Deck. 20" x 19" Section for Corner in Graphite Wood Composite	\$300	\$270	\$25
UD-20-C-I-WA	Upper Deck. 20" x 19" Section for Corner in American Black Walnut	\$400	\$360	\$25
UD-20-C-I-WH	Upper Deck. 20" x 19" Section for Corner in Designer White Resin	\$275	\$248	\$25
UD-24-I-BA	Upper Deck. 24" x 19" Section in Natural Golden Bamboo	\$275	\$248	\$25
UD-24-I-GR	Upper Deck. 24" x 19" Section in Exclusive Gray Resin	\$200	\$180	\$25
UD-24-I-GT	Upper Deck. 24" x 19" Section in Graphite Wood Composite	\$275	\$248	\$25
UD-24-I-WA	Upper Deck. 24" x 19" Section in American Black Walnut	\$375	\$338	\$25
UD-24-I-WH	Upper Deck. 24" x 19" Section in Designer White Resin	\$200	\$180	\$25
UD-30-12-3P-BA	Upper Deck. Three Piece Set for IWS 30S + DD12, IWA 30S + DD12 in Natural Golden Bamboo	\$625	\$563	\$35
UD-30-12-3P-GR	Upper Deck. Three Piece Set for IWS 30S + DD12, IWA 30S + DD12 in Exclusive Gray Resin	\$400	\$360	\$35
UD-30-12-3P-GT	Upper Deck. Three Piece Set for IWS 30S + DD12, IWA 30S + DD12 in Graphite Wood Composite	\$625	\$563	\$35
UD-30-12-3P-WA	Upper Deck. Three Piece Set for IWS 30S + DD12, IWA 30S + DD12 in American Black Walnut	\$925	\$833	\$35
UD-30-12-3P-WH	Upper Deck. Three Piece Set for IWS 30S + DD12, IWA 30S + DD12 in Designer White Resin	\$400	\$360	\$35
UD-30-18-3P-BA	Upper Deck. Three Piece Set for IWS 30S + DD18, IWA 30S + DD18 in Natural Golden Bamboo	\$650	\$585	\$35
UD-30-18-3P-GR	Upper Deck. Three Piece Set for IWS 30S + DD18, IWA 30S + DD18 in Exclusive Gray Resin	\$425	\$383	\$35
UD-30-18-3P-GT	Upper Deck. Three Piece Set for IWS 30S + DD18, IWA 30S + DD18 in Graphite Wood Composite	\$650	\$585	\$35

Product Index

Sorted by product code

Product code	Description	MSRP	UMRP	Freight
UD-30-18-3P-WA	Upper Deck. Three Piece Set for IWS 30S + DD18, IWA 30S + DD18 in American Black Walnut	\$950	\$855	\$35
UD-30-18-3P-WH	Upper Deck. Three Piece Set for IWS 30S + DD18, IWA 30S + DD18 in Designer White Resin	\$425	\$383	\$35
UD-30-2P-BA	Upper Deck. Two Piece Set for IWS 30S, IWA 30S in Natural Golden Bamboo	\$425	\$383	\$35
UD-30-2P-GR	Upper Deck. Two Piece Set for IWS 30S, IWA 30S in Exclusive Gray Resin	\$275	\$248	\$35
UD-30-2P-GT	Upper Deck. Two Piece Set for IWS 30S, IWA 30S in Graphite Wood Composite	\$425	\$383	\$35
UD-30-2P-WA	Upper Deck. Two Piece Set for IWS 30S, IWA 30S in American Black Walnut	\$625	\$563	\$35
UD-30-2P-WH	Upper Deck. Two Piece Set for IWS 30S, IWA 30S in Designer White Resin	\$275	\$248	\$35
UD-3-12-3P-BA	Upper Deck. Three Piece Set for IWS 3S + DD12, IWA 3S + DD12 in Natural Golden Bamboo	\$650	\$585	\$35
UD-3-12-3P-GR	Upper Deck. Three Piece Set for IWS 3S + DD12, IWA 3S + DD12 in Exclusive Gray Resin	\$425	\$383	\$35
UD-3-12-3P-GT	Upper Deck. Three Piece Set for IWS 3S + DD12, IWA 3S + DD12 in Graphite Wood Composite	\$650	\$585	\$35
UD-3-12-3P-WA	Upper Deck. Three Piece Set for IWS 3S + DD12, IWA 3S + DD12 in American Black Walnut	\$950	\$855	\$35
UD-3-12-3P-WH	Upper Deck. Three Piece Set for IWS 3S + DD12, IWA 3S + DD12 in Designer White Resin	\$425	\$383	\$35
UD-3-18-3P-BA	Upper Deck. Three Piece Set for IWS 3S + DD18, IWA 3S + DD18 in Natural Golden Bamboo	\$675	\$608	\$35
UD-3-18-3P-GR	Upper Deck. Three Piece Set for IWS 3S + DD18, IWA 3S + DD18 in Exclusive Gray Resin	\$450	\$405	\$35
UD-3-18-3P-GT	Upper Deck. Three Piece Set for IWS 3S + DD18, IWA 3S + DD18 in Graphite Wood Composite	\$675	\$608	\$35
UD-3-18-3P-WA	Upper Deck. Three Piece Set for IWS 3S + DD18, IWA 3S + DD18 in American Black Walnut	\$975	\$878	\$35
UD-3-18-3P-WH	Upper Deck. Three Piece Set for IWS 3S + DD18, IWA 3S + DD18 in Designer White Resin	\$450	\$405	\$35
UD-3-2P-BA	Upper Deck. Two Piece Set for IWS 3S, IWA 3S in Natural Golden Bamboo	\$450	\$405	\$35
UD-3-2P-GR	Upper Deck. Two Piece Set for IWS 3S, IWA 3S in Exclusive Gray Resin	\$300	\$270	\$35
UD-3-2P-GT	Upper Deck. Two Piece Set for IWS 3S, IWA 3S in Graphite Wood Composite	\$450	\$405	\$35
UD-3-2P-WA	Upper Deck. Two Piece Set for IWS 3S, IWA 3S in American Black Walnut	\$650	\$585	\$35
UD-3-2P-WH	Upper Deck. Two Piece Set for IWS 3S, IWA 3S in Designer White Resin	\$300	\$270	\$35
UD-4-12-3P-BA	Upper Deck. Three Piece Set for IWS 4S + DD12, IWA 4S + DD12 in Natural Golden Bamboo	\$750	\$675	\$35
UD-4-12-3P-GR	Upper Deck. Three Piece Set for IWS 4S + DD12, IWA 4S + DD12 in Exclusive Gray Resin	\$525	\$473	\$35
UD-4-12-3P-GT	Upper Deck. Three Piece Set for IWS 4S + DD12, IWA 4S + DD12 in Graphite Wood Composite	\$750	\$675	\$35
UD-4-12-3P-WA	Upper Deck. Three Piece Set for IWS 4S + DD12, IWA 4S + DD12 in American Black Walnut	\$1,050	\$945	\$35
UD-4-12-3P-WH	Upper Deck. Three Piece Set for IWS 4S + DD12, IWA 4S + DD12 in Designer White Resin	\$525	\$473	\$35
UD-4-18-3P-BA	Upper Deck. Three Piece Set for IWS 4S + DD18, IWA 4S + DD18 in Natural Golden Bamboo	\$775	\$698	\$35
UD-4-18-3P-GR	Upper Deck. Three Piece Set for IWS 4S + DD18, IWA 4S + DD18 in Exclusive Gray Resin	\$550	\$495	\$35
UD-4-18-3P-GT	Upper Deck. Three Piece Set for IWS 4S + DD18, IWA 4S + DD18 in Graphite Wood Composite	\$775	\$698	\$35
UD-4-18-3P-WA	Upper Deck. Three Piece Set for IWS 4S + DD18, IWA 4S + DD18 in American Black Walnut	\$1,075	\$968	\$35
UD-4-18-3P-WH	Upper Deck. Three Piece Set for IWS 4S + DD18, IWA 4S + DD18 in Designer White Resin	\$550	\$495	\$35
UD-4-2P-BA	Upper Deck. Two Piece Set for IWS 4S, IWA 4S, 4D, IWW 4D in Natural Golden Bamboo	\$550	\$495	\$35
UD-4-2P-GR	Upper Deck. Two Piece Set for IWS 4S, IWA 4S, 4D, IWW 4D in Exclusive Gray Resin	\$400	\$360	\$35
UD-4-2P-GT	Upper Deck. Two Piece Set for IWS 4S, IWA 4S, 4D, IWW 4D in Graphite Wood Composite	\$550	\$495	\$35
UD-4-2P-WA	Upper Deck. Two Piece Set for IWS 4S, IWA 4S, 4D, IWW 4D in American Black Walnut	\$750	\$675	\$35
UD-4-2P-WH	Upper Deck. Two Piece Set for IWS 4S, IWA 4S, 4D, IWW 4D in Designer White Resin	\$400	\$360	\$35
UD-4X3-3P-BA	Upper Deck. Three Piece Set for IWS 3X4C, 4X3C, IWA 3X4C, 4X3C in Natural Golden Bamboo	\$775	\$698	\$35
UD-4X3-3P-GR	Upper Deck. Three Piece Set for IWS 3X4C, 4X3C, IWA 3X4C, 4X3C in Exclusive Gray Resin	\$600	\$540	\$35
UD-4X3-3P-GT	Upper Deck. Three Piece Set for IWS 3X4C, 4X3C, IWA 3X4C, 4X3C in Graphite Wood Composite	\$775	\$698	\$35
UD-4X3-3P-WA	Upper Deck. Three Piece Set for IWS 3X4C, 4X3C, IWA 3X4C, 4X3C in American Black Walnut	\$1,075	\$968	\$35
UD-4X3-3P-WH	Upper Deck. Three Piece Set for IWS 3X4C, 4X3C, IWA 3X4C, 4X3C in Designer White Resin	\$600	\$540	\$35
UD-4X4-3P-BA	Upper Deck. Three Piece Set for IWS 4X4C, IWA 4X4C in Natural Golden Bamboo	\$850	\$765	\$35
UD-4X4-3P-GR	Upper Deck. Three Piece Set for IWS 4X4C, IWA 4X4C in Exclusive Gray Resin	\$675	\$608	\$35
UD-4X4-3P-GT	Upper Deck. Three Piece Set for IWS 4X4C, IWA 4X4C in Graphite Wood Composite	\$850	\$765	\$35
UD-4X4-3P-WA	Upper Deck. Three Piece Set for IWS 4X4C, IWA 4X4C in American Black Walnut	\$1,150	\$1,035	\$35
UD-4X4-3P-WH	Upper Deck. Three Piece Set for IWS 4X4C, IWA 4X4C in Designer White Resin	\$675	\$608	\$35
UD-5-3P-BA	Upper Deck. Three Piece Set for IWS 5S, IWW 5D in Natural Golden Bamboo	\$725	\$653	\$35
UD-5-3P-GR	Upper Deck. Three Piece Set for IWS 5S, IWW 5D in Exclusive Gray Resin	\$500	\$450	\$35
UD-5-3P-GT	Upper Deck. Three Piece Set for IWS 5S, IWW 5D in Graphite Wood Composite	\$725	\$653	\$35
UD-5-3P-WA	Upper Deck. Three Piece Set for IWS 5S, IWW 5D in American Black Walnut	\$1,025	\$923	\$35
UD-5-3P-WH	Upper Deck. Three Piece Set for IWS 5S, IWW 5D in Designer White Resin	\$500	\$450	\$35
UD-6-3P-BA	Upper Deck. Three Piece Set for IWS 6S, IWW 6D in Natural Golden Bamboo	\$825	\$743	\$35
UD-6-3P-GR	Upper Deck. Three Piece Set for IWS 6S, IWW 6D in Exclusive Gray Resin	\$600	\$540	\$35
UD-6-3P-GT	Upper Deck. Three Piece Set for IWS 6S, IWW 6D in Graphite Wood Composite	\$825	\$743	\$35
UD-6-3P-WA	Upper Deck. Three Piece Set for IWS 6S, IWW 6D in American Black Walnut	\$1,125	\$1,013	\$35
UD-6-3P-WH	Upper Deck. Three Piece Set for IWS 6S, IWW 6D in Designer White Resin	\$600	\$540	\$35
UD-7-4P-BA	Upper Deck. Four Piece Set for IWS 7S, IWW 7D in Natural Golden Bamboo	\$1,000	\$900	\$35
UD-7-4P-GR	Upper Deck. Four Piece Set for IWS 7S, IWW 7D in Exclusive Gray Resin	\$700	\$630	\$35
UD-7-4P-GT	Upper Deck. Four Piece Set for IWS 7S, IWW 7D in Graphite Wood Composite	\$1,000	\$900	\$35
UD-7-4P-WA	Upper Deck. Four Piece Set for IWS 7S, IWW 7D in American Black Walnut	\$1,400	\$1,260	\$35
UD-7-4P-WH	Upper Deck. Four Piece Set for IWS 7S, IWW 7D in Designer White Resin	\$700	\$630	\$35
W1-15-0-SS	Wash Basin 15-1/2" x 6-5/8" in Stainless Steel	\$200	\$180	\$25
WB-12-L-GR	Lower Tier Wash Bowl 12-1/4" x 17" in Exclusive Gray Resin+	\$215	\$194	\$25
WB-12-L-GT	Lower Tier Wash Bowl 12-1/4" x 17" in Graphite Resin+	\$215	\$194	\$25
WB-12-L-WH	Lower Tier Wash Bowl 12-1/4" x 17" in Designer White Resin+	\$215	\$194	\$25
WC-06-L-GR	Lower Tier Wash Caddy 6" x 17" in Exclusive Gray Resin+	\$185	\$167	\$25
WC-06-L-GT	Lower Tier Wash Caddy 6" x 17" in Graphite Resin+	\$185	\$167	\$25
WC-06-L-WH	Lower Tier Wash Caddy 6" x 17" in Designer White Resin+	\$185	\$167	\$25
WKT-4T-BA	Wash Kit including Four Tools, Two Tools in Natural Golden Bamboo, Two Tools in Exclusive Gray Resin+	\$900	\$810	\$45
WKT-4T-GR	Wash Kit including Four Tools, Two Tools in Exclusive Gray Resin, Two Tools in Exclusive Gray Resin+	\$800	\$720	\$45
WKT-4T-GT	Wash Kit including Four Tools, Two Tools in Graphite Wood Composite, Two Tools in Graphite Resin+	\$900	\$810	\$45
WKT-4T-WA	Wash Kit including Four Tools, Two Tools in American Black Walnut, Two Tools in Graphite Resin+	\$1,000	\$900	\$45
WKT-4T-WH	Wash Kit including Four Tools, Two Tools in Designer White Resin, Two Tools in Designer White Resin+	\$800	\$720	\$45
WM-17-C-BA	Lower Tier Corner Wash & Serve Set with Wash Basin & Large Serving Bowl in Stainless Steel, Platform in Natural Golden Bamboo	\$525	\$473	\$25
WM-17-C-GR	Lower Tier Corner Wash & Serve Set with Wash Basin & Large Serving Bowl in Stainless Steel, Platform in Exclusive Gray Resin	\$450	\$405	\$25

Sold exclusively through independent specialty plumbing, appliance and kitchen design showrooms.

HOMEA

PREMIUM

HOMEA
www.homea.mx
Email: **ventas@homea.mx**
Whatsapp: **(442)258.0251**
Tel: **(442)216.3552**
Lada sin Costo: **01(800)701.2121**

THEGALLEY
■ ■ ■ ■ ■ REINVENT YOUR KITCHEN

The Galley, LLC Headquarters & Showroom

12626 South Memorial Drive
Bixby, OK 74008

The Galley Midwest Office & Showcase

The Merchandise Mart, First Floor
Chicago, IL 60654

TheGalley.com

800 375 4255



Part No. G-PB-2023-US
Printed in the U.S.A. 07/2023

© 2023 The Galley, LLC
All rights reserved.

The Galley reserves the right to change, without previous notice, materials, finishes, drawings, and pricing of the products in this catalog.